

# **bizhub C353/C253/C203**

## **User's Guide [Network Administrator]**





---



## Introduction

Thank you for purchasing this machine.

This User's Guide describes setting methods for each function utilizing bizhub C353/C253/C203, mainly using the PageScope Web Connection. In order to allow functionality of this product fully and to use it effectively, please read through this User's Guide, and then get started.

In order to operate the product safely and properly, be sure to read the Quick Guide [Copy/Print/Fax/Scan/Box Operations].

For descriptions on trademarks and copyrights, refer to the [Trademarks/Copyrights].

Illustrations shown in the User's Guide may differ from actual machine.



# Table of contents

## Introduction

- Table of contents**.....x-2
- About this manual**.....x-8
  - Contents .....x-8
  - Representation of product name .....x-8
  - Explanation of manual conventions .....x-9
- User's Guides**.....x-11
  - Printed manual .....x-11
  - User's Guide CD manuals .....x-11

## 1 Setup items by operation

- 1.1 Specifying general settings for TCP/IP-based communication** ..... 1-2
  - TCP/IP Settings .....1-2
  - Device Setting.....1-3
- 1.2 Using PageScope Web Connection** ..... 1-4
  - 1.2.1 TCP/IP Settings .....1-4
  - 1.2.2 PSWC Settings .....1-4
  - 1.2.3 TCP Socket Setting .....1-5
  - 1.2.4 SSL/TLS Setting .....1-5
- 1.3 Logging in to Administrator mode of PageScope Web Connection**..... 1-6
- 1.4 Creating a certificate for this machine for SSL-based communication**..... 1-7
  - 1.4.1 Create a self-signed Certificate .....1-8
  - 1.4.2 Request a Certificate .....1-9
  - 1.4.3 Install a Certificate .....1-10
  - 1.4.4 Set an Encryption Strength .....1-11
  - 1.4.5 Set Mode using SSL.....1-12
  - 1.4.6 Remove a certificate.....1-12
- 1.5 Acquiring the certificate for this machine**..... 1-13
  - 1.5.1 Create a certificate .....1-13
  - 1.5.2 Download a certificate .....1-13
- 1.6 Registering a user certificate in this machine** ..... 1-14
  - 1.6.1 E-mail Address .....1-14
  - 1.6.2 Automatically Obtain Certificates .....1-15
- 1.7 Specifying the date and time on this machine**..... 1-16
  - 1.7.1 Manual Setting.....1-16
  - 1.7.2 TCP/IP Settings .....1-17
  - 1.7.3 Time Zone .....1-17
  - 1.7.4 Time Adjustment Setting .....1-17
- 1.8 Sending scan data to a Windows computer** ..... 1-19
  - 1.8.1 TCP/IP Settings .....1-19
  - 1.8.2 Client Setting .....1-20
  - 1.8.3 Direct Hosting Setting .....1-21
  - 1.8.4 WINS Setting .....1-22
- 1.9 Sending scan data by E-mail** ..... 1-23
  - 1.9.1 TCP/IP Settings .....1-23
  - 1.9.2 E-mail TX (SMTP).....1-24
    - E-mail TX (SMTP).....1-24
    - Admin. E-mail Address .....1-25
  - 1.9.3 SMTP over SSL/Start TLS .....1-26
    - E-mail TX (SMTP).....1-26
    - Action for Invalid Certificate .....1-26
  - 1.9.4 SMTP Authentication.....1-27

1.9.5	POP before SMTP .....	1-27
	POP before SMTP .....	1-27
	E-mail RX (POP).....	1-28
1.9.6	POP over SSL.....	1-29
	E-mail RX (POP).....	1-29
	Action for Invalid Certificate .....	1-29
1.9.7	APOP Authentication .....	1-30
<b>1.10</b>	<b>Sending scan data by E-mail (With the digital signature attached).....</b>	<b>1-31</b>
1.10.1	TCP/IP Settings .....	1-31
1.10.2	E-mail TX (SMTP).....	1-31
1.10.3	Create a certificate .....	1-31
1.10.4	S/MIME.....	1-32
1.10.5	SMTP over SSL/Start TLS.....	1-32
1.10.6	SMTP Authentication.....	1-32
1.10.7	POP before SMTP .....	1-32
1.10.8	POP over SSL.....	1-32
1.10.9	APOP Authentication.....	1-32
<b>1.11</b>	<b>Sending scan data by E-mail (Public key-based encryption) .....</b>	<b>1-33</b>
1.11.1	TCP/IP Settings .....	1-33
1.11.2	E-mail TX (SMTP).....	1-33
1.11.3	S/MIME.....	1-34
1.11.4	SMTP over SSL/Start TLS.....	1-34
1.11.5	SMTP Authentication.....	1-34
1.11.6	POP before SMTP .....	1-34
1.11.7	POP over SSL.....	1-34
1.11.8	APOP Authentication .....	1-34
<b>1.12</b>	<b>Searching for E-mail addresses from the LDAP server .....</b>	<b>1-35</b>
1.12.1	TCP/IP Settings .....	1-35
1.12.2	Manual Destination Input.....	1-35
1.12.3	LDAP Setting .....	1-36
1.12.4	Setting Up LDAP.....	1-37
1.12.5	LDAP over SSL.....	1-38
	Setting Up LDAP.....	1-38
	Action for Invalid Certificate .....	1-39
1.12.6	DNS Server Settings.....	1-39
1.12.7	Date/Time Setting .....	1-39
<b>1.13</b>	<b>Sending scan data by FTP .....</b>	<b>1-40</b>
1.13.1	TCP/IP Settings .....	1-40
1.13.2	FTP TX Setting.....	1-41
<b>1.14</b>	<b>Sending scan data by WebDAV .....</b>	<b>1-42</b>
1.14.1	TCP/IP Settings .....	1-42
1.14.2	WebDAV Client Settings.....	1-43
1.14.3	WebDAV over SSL.....	1-44
<b>1.15</b>	<b>Sending an Internet fax .....</b>	<b>1-45</b>
1.15.1	TCP/IP Settings .....	1-45
1.15.2	Internet Fax Function.....	1-46
1.15.3	Regist machine information.....	1-47
	Device Mail Address.....	1-47
	Machine Setting.....	1-48
1.15.4	Header Information.....	1-49
1.15.5	E-mail TX (SMTP).....	1-50
1.15.6	I-Fax Advanced Setting .....	1-50
1.15.7	SMTP over SSL/Start TLS.....	1-50
1.15.8	SMTP Authentication.....	1-51
1.15.9	POP before SMTP .....	1-51
1.15.10	POP over SSL.....	1-51
1.15.11	APOP Authentication .....	1-51



<b>1.16</b>	<b>Receiving Internet faxes .....</b>	<b>1-52</b>
1.16.1	TCP/IP Settings .....	1-52
1.16.2	Internet Fax Function.....	1-52
1.16.3	E-mail RX (POP).....	1-53
1.16.4	I-Fax Advance Setting .....	1-54
1.16.5	POP over SSL.....	1-54
1.16.6	APOP Authentication .....	1-54
<b>1.17</b>	<b>Sending and receiving IP address faxes .....</b>	<b>1-55</b>
1.17.1	TCP/IP Settings .....	1-55
1.17.2	IP Address Fax Function .....	1-55
1.17.3	SMTP TX Setting .....	1-56
1.17.4	SMTP RX Setting.....	1-57
1.17.5	Header Information.....	1-57
<b>1.18</b>	<b>Importing images using the TWAIN scan.....</b>	<b>1-58</b>
1.18.1	TCP/IP Settings .....	1-58
1.18.2	SLP Setting.....	1-58
1.18.3	TCP Socket Setting .....	1-59
1.18.4	Network TWAIN .....	1-60
<b>1.19</b>	<b>Printing (LPR/Port9100).....</b>	<b>1-61</b>
1.19.1	TCP/IP Settings .....	1-61
1.19.2	LPD Setting.....	1-61
1.19.3	RAW Port Number.....	1-61
<b>1.20</b>	<b>Printing (SMB) .....</b>	<b>1-62</b>
1.20.1	TCP/IP Settings .....	1-62
1.20.2	Print Setting.....	1-63
1.20.3	WINS Setting .....	1-63
1.20.4	Direct Hosting Setting .....	1-63
<b>1.21</b>	<b>Printing (IPP) .....</b>	<b>1-64</b>
1.21.1	TCP/IP Settings .....	1-64
1.21.2	IPP Setting.....	1-65
1.21.3	IPP Authentication Setting.....	1-66
<b>1.22</b>	<b>Printing (IPPS) .....</b>	<b>1-67</b>
1.22.1	TCP/IP Settings .....	1-67
1.22.2	IPP Setting.....	1-67
1.22.3	SSL/TLS Setting .....	1-67
1.22.4	IPP Authentication Setting.....	1-68
<b>1.23</b>	<b>Printing (Bonjour).....</b>	<b>1-69</b>
	Bonjour Setting.....	1-69
<b>1.24</b>	<b>Printing (AppleTalk) .....</b>	<b>1-70</b>
	AppleTalk Setting .....	1-70
<b>1.25</b>	<b>Printing (NetWare) .....</b>	<b>1-71</b>
1.25.1	NetWare Setting .....	1-71
	For Remote Printer mode with NetWare 4.x bindery emulation.....	1-71
	For the print server mode with NetWare 4.x bindery emulation.....	1-72
	For NetWare 4.x Remote Printer mode (NDS).....	1-72
	For NetWare 4.x/5.x/6 Print Server mode (NDS).....	1-73
	For NetWare 5.x/6 Novell Distributed Print Service (NDPS).....	1-73
1.25.2	NetWare Status .....	1-74
<b>1.26</b>	<b>Using the WS-Print function .....</b>	<b>1-75</b>
1.26.1	TCP/IP Settings .....	1-75
1.26.2	Web Service Common Settings .....	1-76
1.26.3	Printer Settings.....	1-77
<b>1.27</b>	<b>Using the WS-Scan function.....</b>	<b>1-78</b>
1.27.1	TCP/IP Settings .....	1-78
1.27.2	Web Service Common Settings .....	1-79
1.27.3	Scanner Settings .....	1-80

<b>1.28</b>	<b>Using SSL for communication from Vista to this machine with Web Service .....</b>	<b>1-81</b>
1.28.1	TCP/IP Settings .....	1-81
1.28.2	SSL/TLS Setting .....	1-81
1.28.3	Web Service Common Settings .....	1-81
<b>1.29</b>	<b>Using SSL for communication from this machine to Vista with Web Service .....</b>	<b>1-82</b>
1.29.1	TCP/IP Settings .....	1-82
1.29.2	Web Service Common Settings .....	1-82
1.29.3	Action for Invalid Certificate .....	1-83
<b>1.30</b>	<b>Monitoring this machine using the SNMP manager.....</b>	<b>1-84</b>
1.30.1	TCP/IP Settings .....	1-84
1.30.2	NetWare Setting .....	1-84
1.30.3	SNMP Setting .....	1-85
<b>1.31</b>	<b>Providing notification of the status of this machine (E-mail) .....</b>	<b>1-87</b>
1.31.1	TCP/IP Settings .....	1-87
1.31.2	E-mail TX (SMTP).....	1-87
1.31.3	Status Notification Setting.....	1-88
1.31.4	SMTP over SSL/Start TLS .....	1-89
1.31.5	SMTP Authentication.....	1-89
1.31.6	POP before SMTP .....	1-89
1.31.7	POP over SSL.....	1-89
1.31.8	APOP Authentication .....	1-89
<b>1.32</b>	<b>Providing notification of the status of this machine (TRAP).....</b>	<b>1-90</b>
1.32.1	TCP/IP Settings .....	1-90
1.32.2	NetWare Setting .....	1-91
1.32.3	TRAP Setting .....	1-91
1.32.4	Status Notification Setting.....	1-91
<b>1.33</b>	<b>Providing notification of the counter information of this machine via E-mail .....</b>	<b>1-92</b>
1.33.1	TCP/IP Settings .....	1-92
1.33.2	E-mail TX (SMTP).....	1-93
1.33.3	Total Counter Notification Setting .....	1-94
1.33.4	SMTP over SSL/Start TLS .....	1-94
1.33.5	SMTP Authentication.....	1-95
1.33.6	POP before SMTP .....	1-95
1.33.7	POP over SSL.....	1-95
1.33.8	APOP Authentication .....	1-95
1.33.9	Meter Count.....	1-95
<b>1.34</b>	<b>Limiting users using this machine (Machine authentication).....</b>	<b>1-96</b>
1.34.1	User Auth/Account Track .....	1-97
1.34.2	User Registration .....	1-98
1.34.3	Account Track Registration .....	1-100
<b>1.35</b>	<b>Limiting users using this machine (Active Directory).....</b>	<b>1-102</b>
1.35.1	TCP/IP Settings .....	1-102
1.35.2	External Server Registration .....	1-103
1.35.3	User Auth/Account Track .....	1-104
1.35.4	Default Function Permission.....	1-105
1.35.5	Date/Time Setting .....	1-105
<b>1.36</b>	<b>Limiting users using this machine (Windows domain/workgroup).....</b>	<b>1-106</b>
1.36.1	TCP/IP Settings .....	1-106
1.36.2	External Server Registration .....	1-107
1.36.3	User Auth/Account Track .....	1-108
1.36.4	Default Function Permission.....	1-108
1.36.5	Client Setting .....	1-109
1.36.6	WINS Setting .....	1-109
1.36.7	Direct Hosting Setting .....	1-109
<b>1.37</b>	<b>Limiting users using this machine (NDS).....</b>	<b>1-110</b>
1.37.1	External Server Registration .....	1-110

1.37.2	User Auth/Account Track .....	1-111
1.37.3	Default Function Permission.....	1-111
1.37.4	NetWare Setting .....	1-112
<b>1.38</b>	<b>Limiting users using this machine (LDAP).....</b>	<b>1-113</b>
1.38.1	TCP/IP Settings .....	1-113
1.38.2	External Server Registration .....	1-114
1.38.3	User Auth/Account Track .....	1-115
1.38.4	Default Function Permission.....	1-115
1.38.5	LDAP over SSL .....	1-116
	External Server Registration .....	1-116
	Action for Invalid Certificate .....	1-116
<b>1.39</b>	<b>Performing IP address filtering .....</b>	<b>1-117</b>
1.39.1	TCP/IP Settings .....	1-117
1.39.2	IP Filtering .....	1-117
<b>1.40</b>	<b>Communicating using IPv6 .....</b>	<b>1-118</b>
	TCP/IP Setting .....	1-119
<b>1.41</b>	<b>Communicating using IPsec.....</b>	<b>1-121</b>
1.41.1	TCP/IP Settings .....	1-121
1.41.2	IPsec .....	1-122
1.41.3	IKE Setting .....	1-123
1.41.4	SA Setting .....	1-123
1.41.5	Peer .....	1-124
<b>1.42</b>	<b>Using the TCP Socket/OpenAPI function.....</b>	<b>1-125</b>
1.42.1	TCP/IP Settings .....	1-125
1.42.2	SSL/TLS Setting .....	1-125
1.42.3	TCP Socket Setting .....	1-126
1.42.4	OpenAPI Setting .....	1-127
<b>1.43</b>	<b>Using FTP server/WebDAV server functions .....</b>	<b>1-128</b>
1.43.1	TCP/IP Settings .....	1-128
1.43.2	SSL/TLS Setting .....	1-128
1.43.3	FTP Server Setting.....	1-129
1.43.4	WebDAV Server Settings.....	1-130
<b>1.44</b>	<b>Other items on the Maintenance tab .....</b>	<b>1-131</b>
1.44.1	Using external memory.....	1-131
	External Memory Function Settings .....	1-131
1.44.2	Using the timer function .....	1-132
	Power Save Setting .....	1-132
	Weekly Timer Setting.....	1-133
1.44.3	Importing or exporting setting information .....	1-134
	Import/Export.....	1-134
1.44.4	Resetting setting information.....	1-135
	Network Setting Clear .....	1-135
	Reset.....	1-136
	Format All Destination .....	1-136
1.44.5	Specifying support information .....	1-137
	Online Assistance .....	1-137
1.44.6	Registering the header or footer.....	1-138
	Header/Footer Registration .....	1-138
1.44.7	Checking the ROM version.....	1-139
	ROM Version.....	1-139
1.44.8	Extending functions of MFP .....	1-140
	Get Request Code.....	1-140
	Install License .....	1-141
<b>1.45</b>	<b>Other items on the Security tab .....</b>	<b>1-142</b>
1.45.1	Limiting accessible destinations by user.....	1-142
	Reference Allowed Group Registration .....	1-142
	Public User Reference Setting.....	1-143

1.45.2	Restricting address registration by a user .....	1-143
	Permission of Address Change .....	1-143
1.45.3	Specifying the auto logout time .....	1-144
	Auto Logout .....	1-144
1.45.4	Specifying the administrator password .....	1-145
	Administrator Password Setting .....	1-145
<b>1.46</b>	<b>Box tab settings .....</b>	<b>1-146</b>
1.46.1	Changing user box settings or deleting a user box .....	1-146
	Open User Box .....	1-146
1.46.2	Creating a new user box .....	1-147
	Create User Box .....	1-147
1.46.3	Changing system box settings or deleting system boxes .....	1-148
	Open System User Box .....	1-148
1.46.4	Creating a new system user box .....	1-149
	Create System User Box .....	1-149
<b>1.47</b>	<b>Print Setting tab settings .....</b>	<b>1-151</b>
1.47.1	Specifying initial settings for the print function .....	1-151
	Basic Setting .....	1-151
1.47.2	Specifying settings for PCL/PS/XPS print .....	1-152
	PCL Settings .....	1-152
	PS Setting .....	1-153
	XPS Settings .....	1-154
1.47.3	Specifying the interface timeout .....	1-154
	Interface Setting .....	1-154
<b>1.48</b>	<b>Store Address tab settings .....</b>	<b>1-155</b>
1.48.1	Registering or editing an address book destination .....	1-155
	Store Address .....	1-155
	Icon .....	1-158
1.48.2	Registering or editing a group destination .....	1-159
	Group .....	1-159
1.48.3	Registering or editing a program destination .....	1-160
	Program address .....	1-160
1.48.4	Registering or editing destinations to be temporarily used .....	1-169
	Temporary One-Touch .....	1-169
1.48.5	Registering E-mail subject or text .....	1-170
	Subject .....	1-170
	Text .....	1-170
1.48.6	Using an application registered in an external server .....	1-171
	Application Registration .....	1-172
1.48.7	Simplifying E-mail address entry .....	1-174
	Prefix/Suffix .....	1-174

## 2 Network Settings

<b>2.1</b>	<b>Displaying the Network Settings screen .....</b>	<b>2-2</b>
<b>2.2</b>	<b>Network Settings menu list .....</b>	<b>2-4</b>
2.2.1	Network Settings screen (1/2) .....	2-4
2.2.2	Network Settings screen (2/2) .....	2-14

## 3 Appendix

<b>3.1</b>	<b>Product Specifications (Network functions) .....</b>	<b>3-2</b>
<b>3.2</b>	<b>Glossary .....</b>	<b>3-3</b>

## 4 Index

<b>4.1</b>	<b>Index .....</b>	<b>4-2</b>
------------	--------------------	------------



## About this manual

This document is a user's guide summarizing setup procedures for enabling effective usages of the product utilizing the networking functions. For copy, scan, box, and fax operations, refer to the respective User's Guides.

This manual is intended for persons with basic knowledge of computers and the copier. For details on the Windows or Macintosh operating systems, or software applications, refer to the respective manuals.

## Contents

This manual consists of the following chapters:

Chapter 1 Setup items by operation

Chapter 2 Network Settings

Chapter 3 Appendix

Chapter 4 Index

## Representation of product name

Product name	Representation
bizhub C353/C253/C203	Machine, copier, or printer
Microsoft Windows	Windows

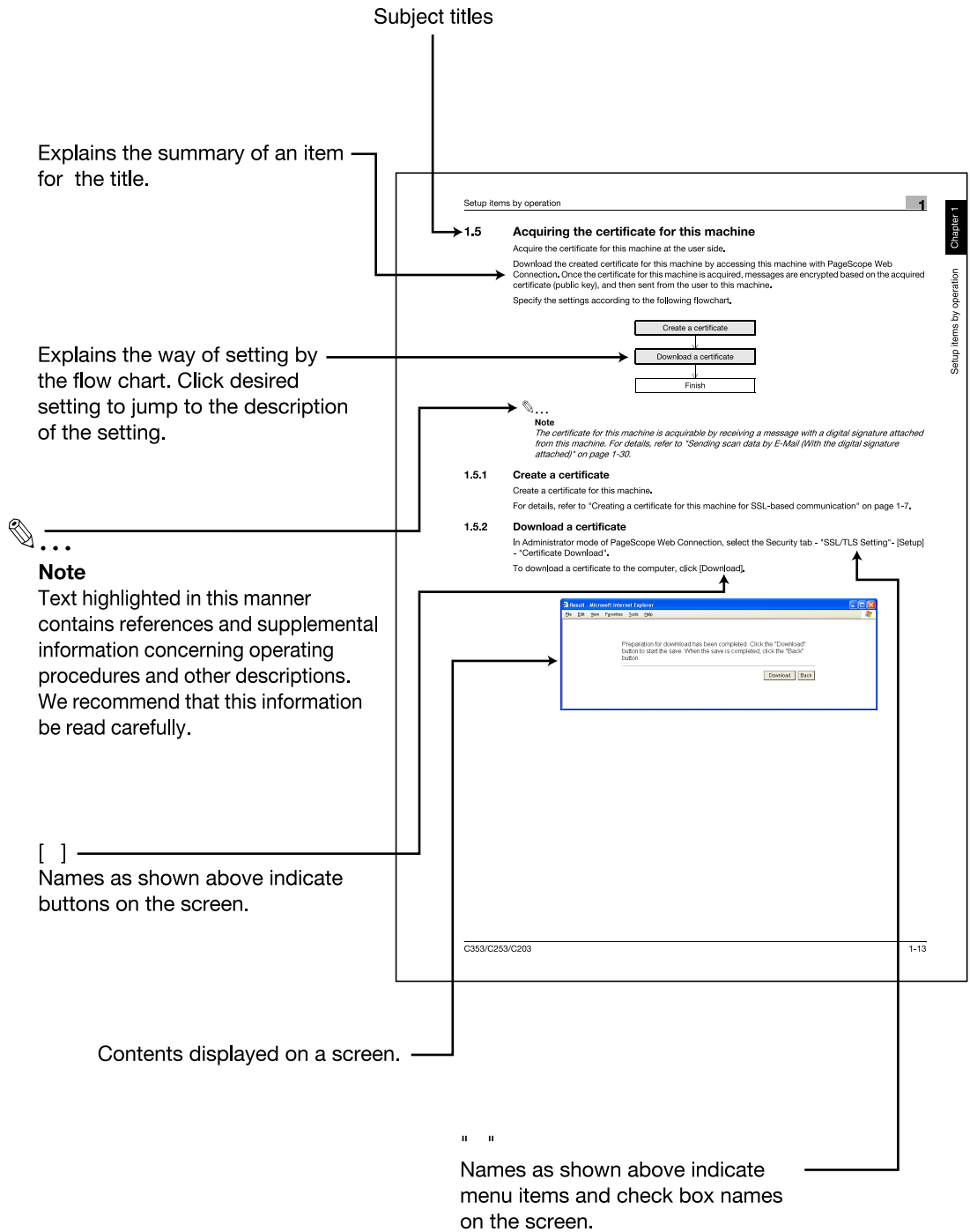

(The page shown above is an example only.)



**Detail**

Text highlighted in this manner provides more detailed information concerning operating procedures or references to sections containing additional information. If necessary, refer to the indicated sections.

Chapter 2  
Network Settings

2 Network Settings

2.1 Displaying the Network Settings screen

Settings by purpose can be specified via network settings in the control panel of the machine.

Access network settings from the Administrator Settings screen. Perform the following steps to display the Network Settings screen.

**Detail**  
When logged in to Administrator mode, the control panel of the machine is locked and cannot be used. Depending on the status of the machine, you may not be able to log in to Administrator mode.

1 Press the [Utility/Counter] key.

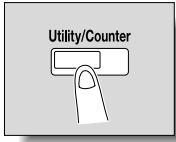

2 Touch [3 Administrator Settings].

- When setting the Utility screen, you can also select a setting by using the keypad to enter the number next to the desired button. To select [3 Administrator Settings], press the [3] key in the keypad.

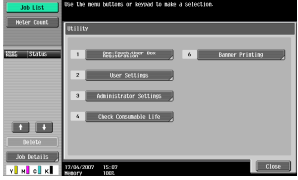

3 Type in the password, and then touch [OK].

**Reminder**  
If "Prohibited Functions When Authentication Error" in Administrator mode is set to "Mode 2" and an incorrect password is entered the specified number of times, it is no longer possible to log in to Administrator mode. For details on the "Prohibited Functions When Authentication Failed" parameter, refer to the User's Guide [Copy Operations].

2-2 C353/C253/C203

[ ] Names as shown above indicate keys on the control panel, buttons in the touch panel, and the power switches.

Explains the operation procedure.

Touch panel screens are shown to check the actual display.



**Reminder**

Text highlighted in this manner indicates operation precautions. Carefully read and observe this type of information.

(The page shown above is an example only.)

---

## User's Guides

This machine is provided with printed manuals and PDF manuals on the User's Guide CD.

### Printed manual

#### ***Quick Guide [Copy/Print/Fax/Scan/Box Operations]***

This manual contains operating procedures and descriptions of the most frequently used functions, allowing the machine to immediately be used.

In addition, this manual contains notes and precautions that should be followed for safe use of the machine.

Be sure to read this manual before using the machine.

### User's Guide CD manuals

#### ***User's Guide [Copy Operations]***

This manual contains descriptions of the Copy mode operations and machine maintenance.

Refer to this manual for details on the paper and originals, copy procedures using convenient Application functions, replacing consumables, and troubleshooting operations such as clearing paper misfeeds.

#### ***User's Guide [Enlarge Display Operations]***

This manual contains details on operating procedures in Enlarge Display mode.

Refer to this manual for details on using copy, scanner, G3 fax, and network fax operations in Enlarge Display mode.

#### ***User's Guide [Print Operations]***

This manual contains details of the printing functions that can be specified with the standard built-in printer controller.

Refer to this manual for operating procedures on using the printing functions.

#### ***User's Guide [Box Operations]***

This manual contains operating procedures for using the user boxes on the hard disk.

Refer to this manual for details on saving data in user boxes, retrieving data from user boxes and transferring data.

#### ***User's Guide [Network Scan/Fax/Network Fax Operations]***

This manual contains details on the network scan, G3 fax, and network fax operations.

Refer to this manual for details on using network scan function by E-Mail or FTP, G3 fax, Internet fax and IP address fax operations.

In order to use the fax functions, the optional fax kit must be purchased separately.

#### ***User's Guide [Fax Driver Operations]***

This manual contains details of the fax driver functions that can be used to send a fax directly from a computer.

Refer to this manual for operating procedures on using the PC-FAX functions.

In order to use the fax functions, the optional fax kit must be purchased separately.

#### ***User's Guide [Network Administrator] (this manual)***

This manual contains descriptions on setting methods for each function utilizing network connection, mainly using the PageScope Web Connection.

Refer to this manual for details on using network functions.

#### ***User's Guide [Advanced Function Operations]***

This User's Guide describes overview and usage of functions that become available by registering the optional license kit and enabling its function, and functions that become available by connecting the MFP with applications.

In order to use the functions effectively, please read this User's Guide.

The following models support the advanced function.

bizhub C650/C550/C451/C353/C253/C203



---



***Trademarks/Copyrights***

This manual contains descriptions on trademarks and copyrights.

Be sure to read this manual before using the machine

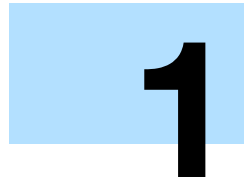

**Setup items by operation**

---

# 1 Setup items by operation

## 1.1 Specifying general settings for TCP/IP-based communication

Specify settings to use this machine in a TCP/IP network environment. To use this machine by connecting to the network, specify these settings in advance.



### Reminder

*In order to apply all changes to the network settings, turn off this machine, then on again.*

*When turning off the main power switch and turning it on again, wait for 10 seconds or longer after power-off, and then turn on the power again. The machine may not operate correctly if it is turned on immediately after being turned off.*

### TCP/IP Settings

On the Administrator Settings screen of the control panel, select [Network Settings] - [1 TCP/IP Settings].

Specify the following settings.



### Note

*For details on displaying the Network Setting screen, refer to "[Displaying the Network Settings screen](#)" on page 2-2.*

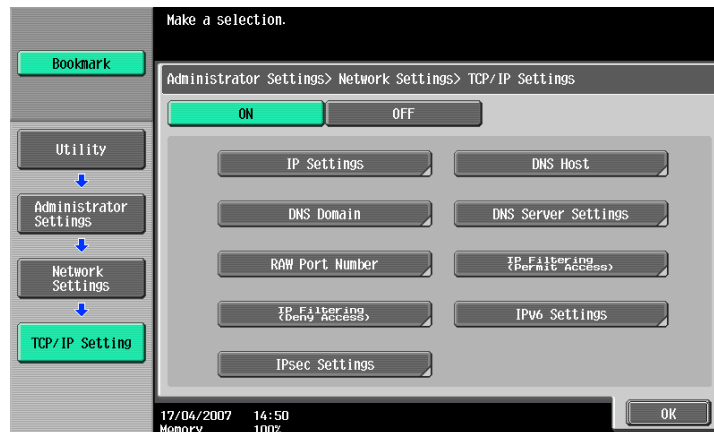

Item	Definition	Prior confirmation
TCP/IP Settings	Select [ON].	
IP Application Method	Select whether the IP address is automatically acquired or directly specified.	IP application method to be used
IP Application Method Auto Setting	To automatically acquire the IP address, select the automatic acquisition method.	
IP Address	To directly specify the IP address, specify the IP address of this machine.	IP address of this machine
Subnet Mask	To directly specify the IP address, specify the subnet mask of the network to be connected.	Subnet mask of this machine
Default Gateway	To directly specify the IP address, specify the default gateway of the network to be connected.	Default gateway of this machine
Dynamic DNS Settings	To automatically register the host name specified with [DNS Host Name] for the DNS server that supports the Dynamic DNS function, select [Enable].	Whether Dynamic DNS is used
DNS Host Name	Specify the host name of this machine (up to 63 characters).	

Item	Definition	Prior confirmation
DNS Domain Name Auto Retrieval	Select whether to automatically acquire the name of the DNS domain. This item is enabled when the DHCP is enabled.	Whether automatic acquisition is available with DHCP
Default DNS Domain Name	If not acquiring the DNS domain name automatically, specify the domain name to which this machine belongs (up to 255 characters including the host name).	Default Domain Name
DNS Search Domain Name 1 to 3	Specify the DNS search domain name (up to 253 characters).	
DNS Server Auto Obtain	Specify whether to automatically acquire the DNS server address. This item is enabled when the DHCP is enabled.	Whether automatic acquisition is available with DHCP
Priority DNS Server	If not automatically acquiring the DNS server address, specify the address of the priority DNS server.	Address of the server
Secondary DNS Server 1 and 2	Specify the address of an alternate DNS server.	Address of the server

### Device Setting

On the Administrator Settings screen of the control panel, select [Network Settings] - [5 Detail Settings] - [1 Device Setting].

Specify the following settings.

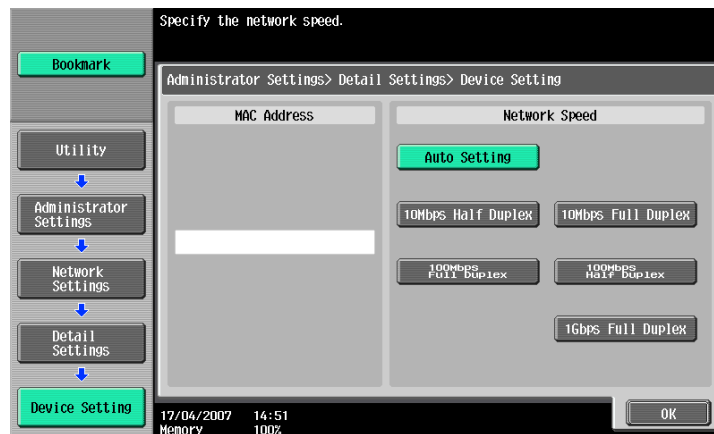

Item	Definition	Prior confirmation
MAC Address	Displays the MAC address of the network interface card for this machine.	
Network Speed	Specify the network speed.	

## 1.2 Using PageScope Web Connection

Specify settings for using PageScope Web Connection. This manual describes how to specify settings required for each operation using PageScope Web Connection.

PageScope Web Connection is a device management utility supported by the HTTP server integrated into the printer controller. Using a Web browser on a computer connected to the network, machine settings can be specified and the status of the machine can be checked. Some settings can be specified from the computer instead of from the machine control panel.

Specify the settings according to the following flowchart.

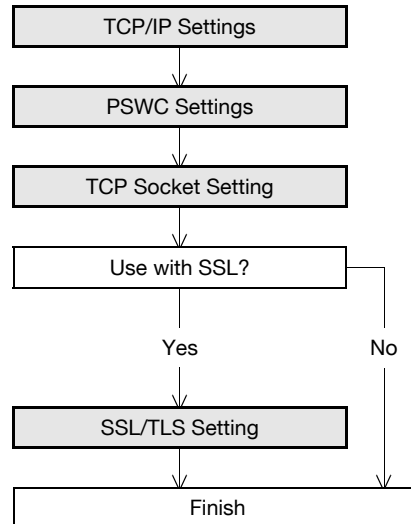

### 1.2.1 TCP/IP Settings

Specify settings to use this machine in a TCP/IP network environment.

For details, refer to ["Specifying general settings for TCP/IP-based communication" on page 1-2.](#)

### 1.2.2 PSWC Settings

On the Administrator Settings screen of the control panel, select [Network Settings] - [3 HTTP Server Settings].

Specify the following setting.



**Note**

For details on displaying the Network Setting screen, refer to ["Displaying the Network Settings screen" on page 2-2.](#)



Item	Definition	Prior confirmation
PSWC Settings	Select [ON].	

### 1.2.3 TCP Socket Setting

In Administrator mode of PageScope Web Connection, select the Network tab - "TCP Socket Setting".  
Specify the following settings.



**Note**

For details on logging in to Administrator mode of PageScope Web Connection, refer to "[Logging in to Administrator mode of PageScope Web Connection](#)" on page 1-6.

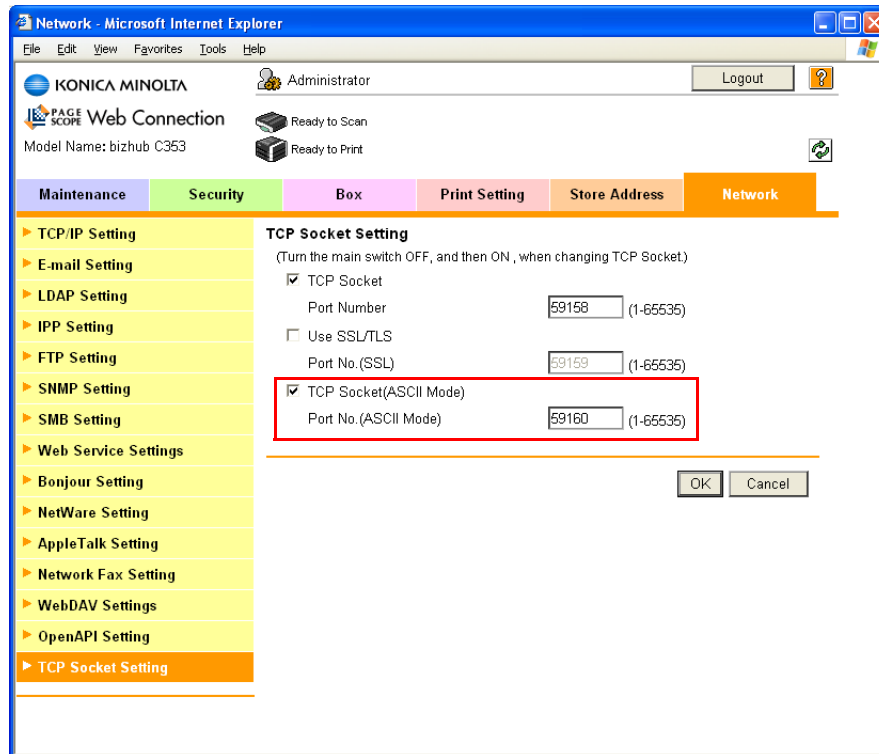

Item	Definition	Prior confirmation
TCP Socket (ASCII Mode)	To use in the Flash format, select the "TCP Socket (ASCII Mode)" check box.	
Port No. (ASCII Mode)	Specify the port number.	

### 1.2.4 SSL/TLS Setting

Specifying settings for SSL-based communication

For details, refer to "[Creating a certificate for this machine for SSL-based communication](#)" on page 1-7.

## 1.3 Logging in to Administrator mode of PageScope Web Connection

To specify settings for this machine with PageScope Web Connection, Administrator mode must be logged in. The following shows how to log in to Administrator mode.



### Detail

*When logged in to Administrator mode, the control panel of the machine is locked and cannot be used.*

*Depending on the status of the machine, you may not be able to log in to Administrator mode.*

- 1 In the login page, select "Administrator", and then click the [Login] button.
  - If necessary, select the display language and format. If "When in warning, the dialog is displayed." check box is selected, warning messages appear during operation after logging in.

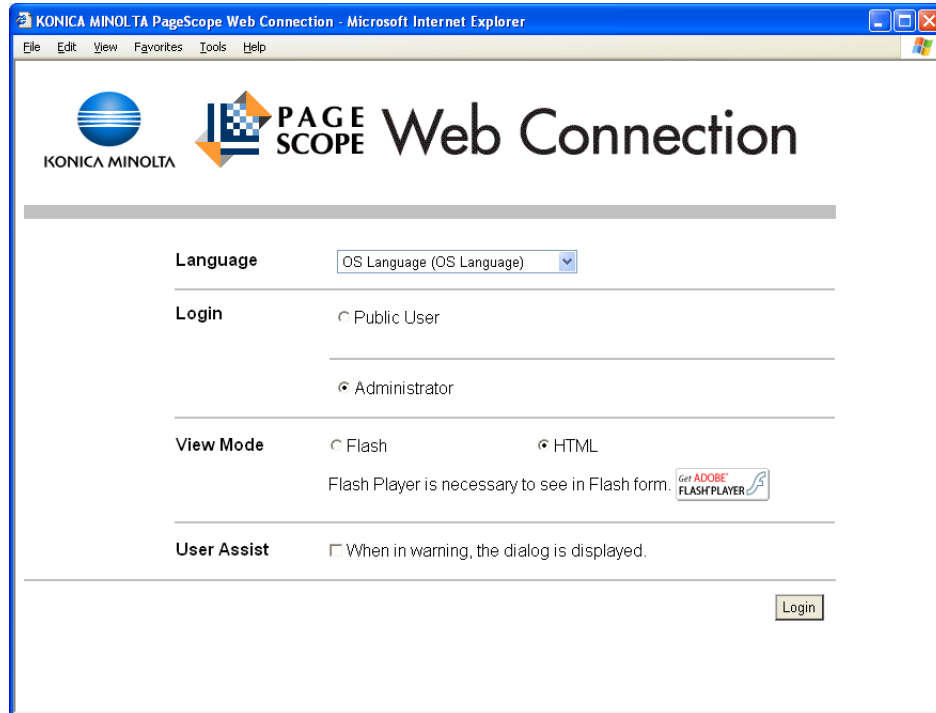

- 2 Enter the password for the machine's administrator.

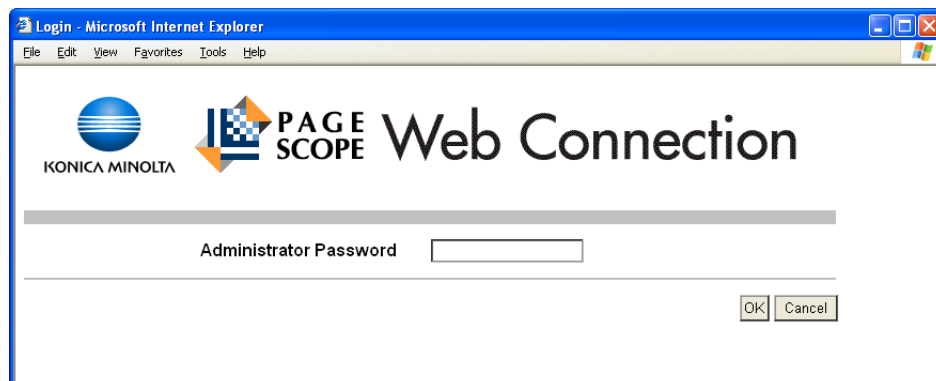

- 3 Click the [OK] button.  
The Administrator mode page appears.



### Reminder

*If "Prohibited Functions When Authentication Error" in Administrator mode is set to "Mode 2" and an incorrect password is entered the specified number of times, it is no longer possible to log in to Administrator mode. For details on the "Prohibited Functions When Authentication Failed" parameter, refer to the User's Guide [Copy Operations].*

## 1.4 Creating a certificate for this machine for SSL-based communication

Specify settings to create a certificate for this machine for SSL-based communication.

Creating a certificate for this machine encrypts communication from a client computer to this machine using SSL in order to prevent disclosure of communication contents and password.

Specify the settings according to the following flowchart.

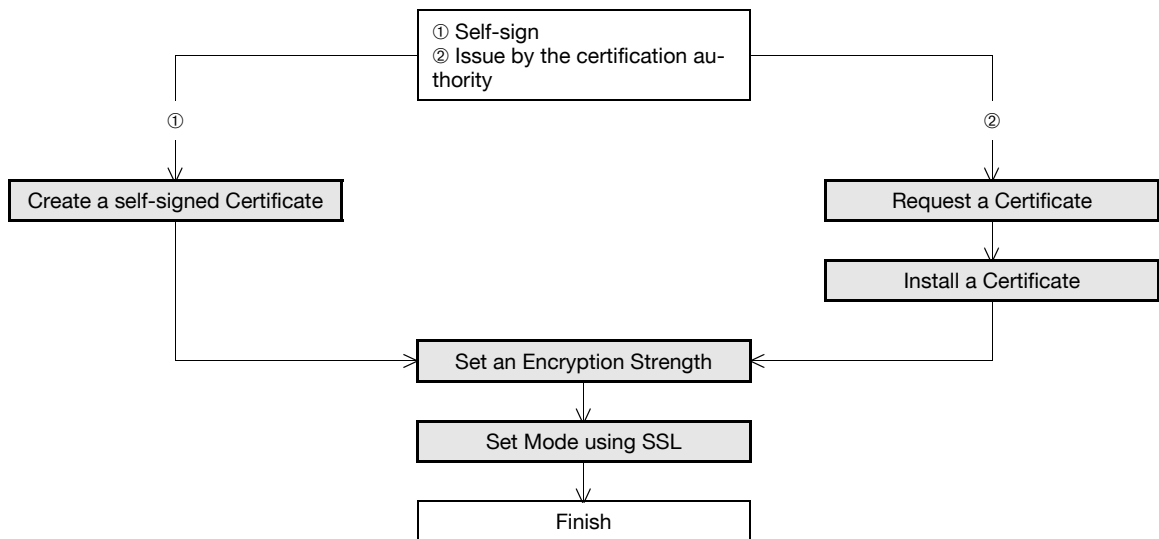

### Detail

When specifying the following settings, communication from a client computer to this machine can be encrypted using SSL. For details, refer to the respective sections.

["Using PageScope Web Connection" on page 1-4](#)

["Printing \(IPPS\)" on page 1-67](#)

["Using SSL for communication from Vista to this machine with Web Service" on page 1-81](#)

["Using the TCP Socket/OpenAPI function" on page 1-125](#)

["Using FTP server/WebDAV server functions" on page 1-128](#)



### 1.4.1 Create a self-signed Certificate

In Administrator mode of PageScope Web Connection, select the Security tab - "SSL/TLS Setting" - "SSL/TLS Setting" - [Setting] - "Create a self-signed Certificate".

Specify the following settings.

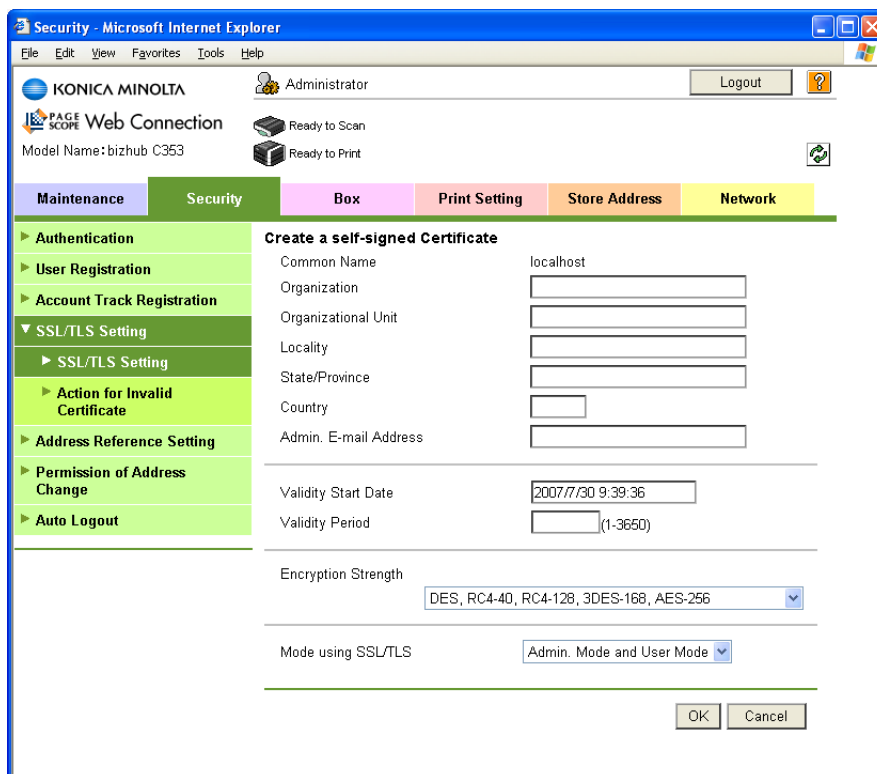

Item	Definition	Prior confirmation
Common Name	Displays the IP address or domain name of the machine.	
Organization	Enter the name of the organization or group used for creating an organization certificate (up to 63 characters).	
Organizational Unit	Enter the name of the account used for creating an account certificate (up to 63 characters).	
Locality	Enter the name of the locality used for creating a locality certificate (up to 127 characters).	
State/Province	Enter the name of the state/province used for creating a state/province certificate (up to 127 characters).	
Country	When creating a country certificate, enter a two-character country code regulated by ISO 3166. United States: US, Great Britain: GB, Italy: IT, Australia: AU, The Netherlands: NL, Canada: CA, Spain: ES, Czech Republic: CZ, China: CN, Denmark: DK, Germany: DE, Japan: JP, France: FR, Belgium: BE, Russia: RU	
Admin. E-mail Address	Enter the address for the administrator (up to 127 characters).	Address for the administrator
Validity Start Date	Enter the starting date for the period of validity. Displays the date and time when this page was displayed.	
Validity Period	Enter the number of days from the starting date for the period of validity for the certificate.	
Encryption Strength	Specify the encryption method.	
Mode using SSL/TLS	Specify the mode using SSL/TLS.	
[OK]	Creates a self-signed certificate. It may take a few minutes to create a certificate.	

## 1.4.2 Request a Certificate

In Administrator mode of PageScope Web Connection, select the Security tab - "SSL/TLS Setting" - "SSL / TLS Setting" - [Setup] - "Request a Certificate".

Specify the following settings.

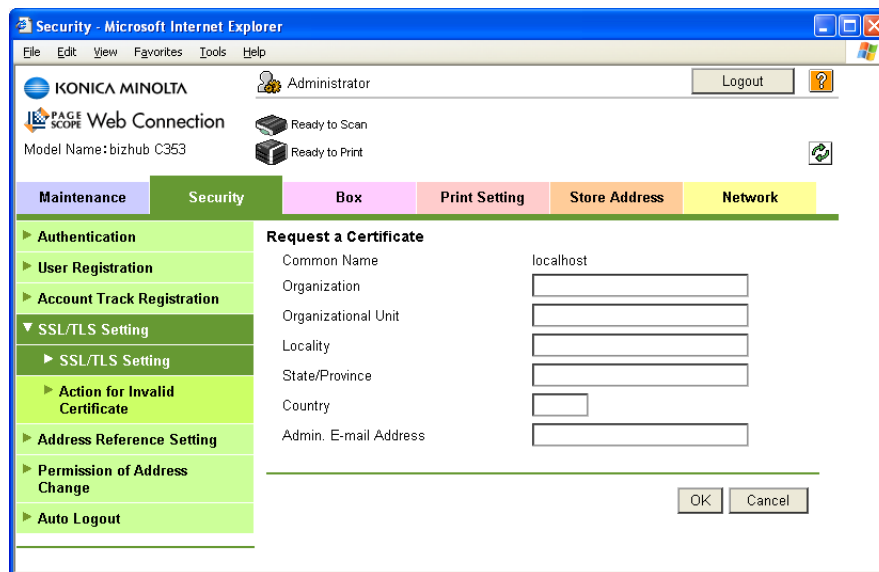

Item	Definition	Prior confirmation
Common Name	Displays the IP address or domain name of the machine.	
Organization	Enter the name of the organization or group used for creating an organization certificate (up to 63 characters).	
Organizational Unit	Enter the name of the account used for creating an account certificate (up to 63 characters).	
Locality	Enter the name of the locality used for creating a locality certificate (up to 127 characters).	
State/Province	Enter the name of the state or province used for creating a state/province certificate (up to 127 characters).	
Country	When creating a country certificate, enter a two-character country code regulated by ISO 3166. United States: US, Great Britain: GB, Italy: IT, Australia: AU, The Netherlands: NL, Canada: CA, Spain: ES, Czech Republic: CZ, China: CN, Denmark: DK, Germany: DE, Japan: JP, France: FR, Belgium: BE, Russia: RU	
Admin. E-mail Address	Specify the address for the administrator (up to 127 characters).	Address for the administrator
[OK]	Creates certificate signing request data.	

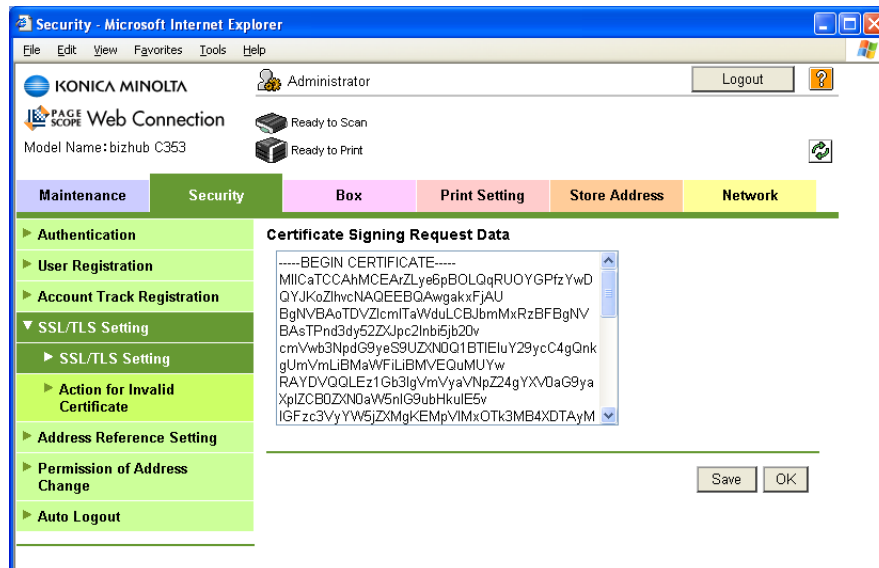

Item	Definition	Prior confirmation
Certificate Signing Request Data	Displays certificate signing request data.	
[Save]	Saves certificate signing request data in the computer as a file.	

### 1.4.3 Install a Certificate

In Administrator mode of PageScope Web Connection, select the Security tab - "SSL/TLS Setting" - "SSL / TLS Setting" - [Setup] - "Install a Certificate".

After requesting a certificate to the certification authority, install the certificate sent from the certification authority on this machine.

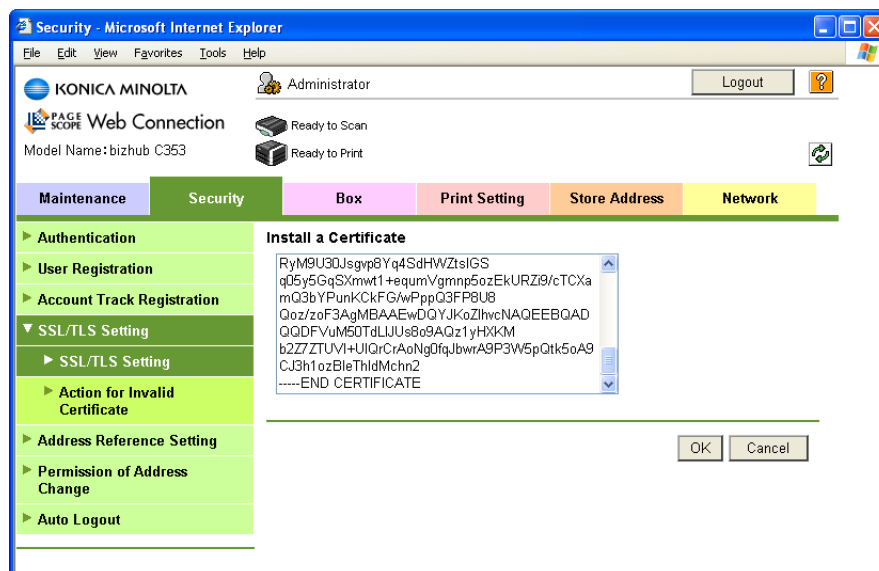

Item	Definition	Prior confirmation
Install a Certificate	Paste text data sent from the certification authority.	
[OK]	Moves to the Set an Encryption Strength and Set Mode using SSL screen.	

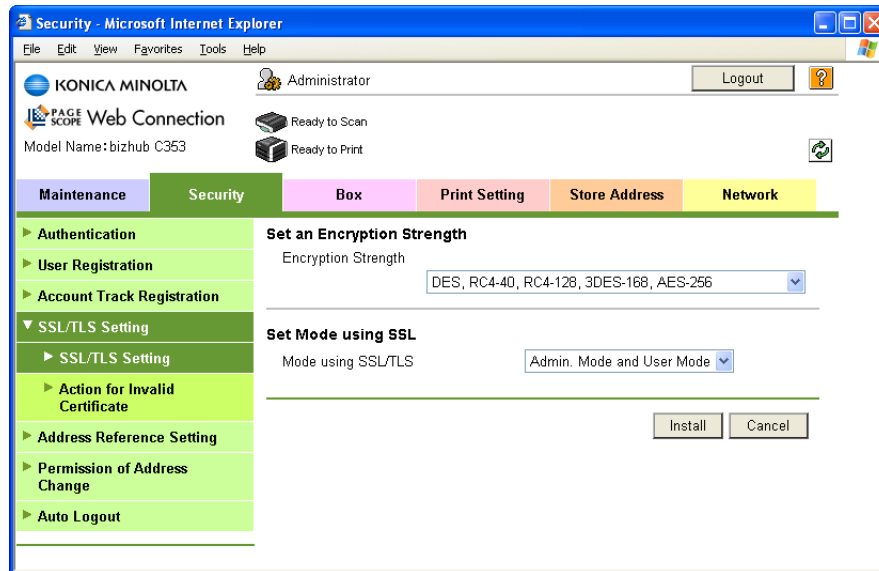

Item	Definition	Prior confirmation
Encryption Strength	Specify the encryption method.	
Mode using SSL/TLS	Specify the SSL/TLS application range.	
[Install]	Installs the certificate.	

### 1.4.4 Set an Encryption Strength

In Administrator mode of PageScope Web Connection, select the Security tab - "SSL/TLS Setting" - "SSL / TLS Setting" - [Setup] - "Set an Encryption Strength".

Specify the following setting.

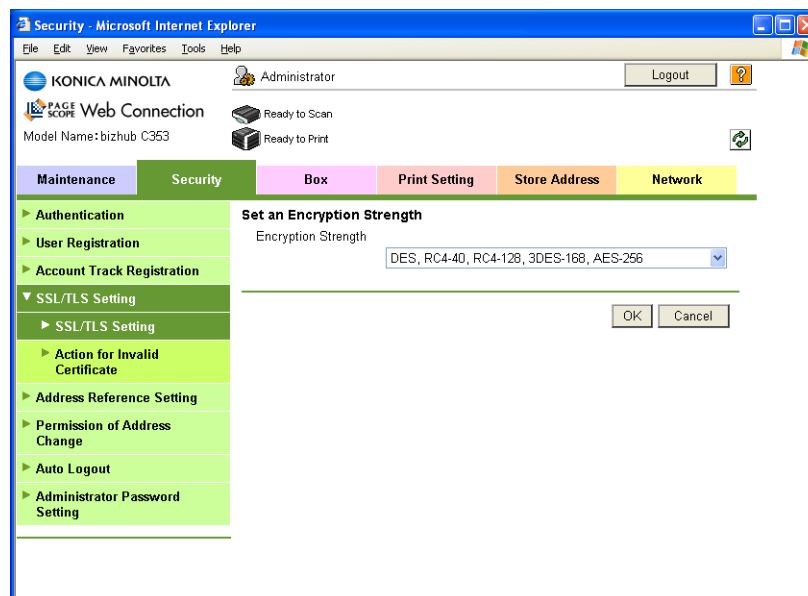

Item	Definition	Prior confirmation
Encryption Strength	If necessary, change the set encryption strength. Specify the encryption strength.	

### 1.4.5 Set Mode using SSL

In Administrator mode of PageScope Web Connection, select the Security tab - "SSL/TLS Setting" - "SSL / TLS Setting" - [Setup] - "Set Mode using SSL".

Specify the following setting.

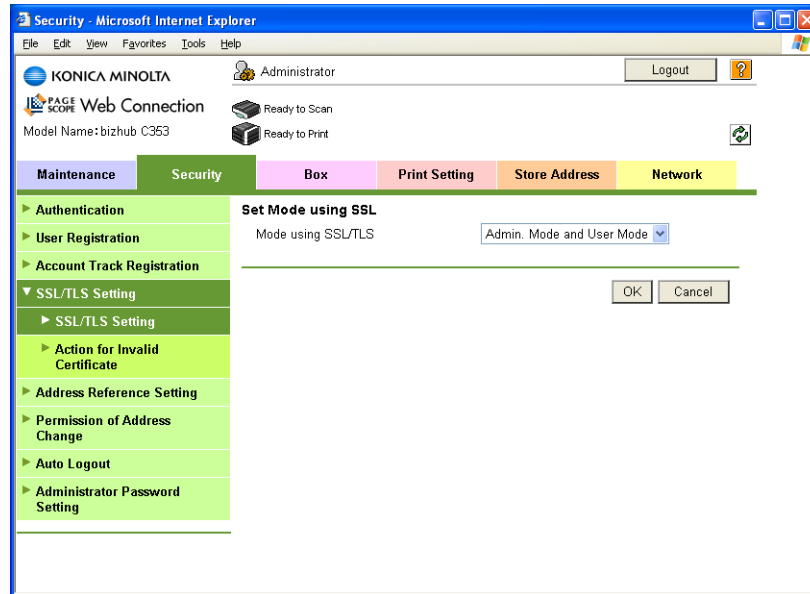

Item	Definition	Prior confirmation
Mode using SSL/TLS	If necessary, change the set SSL/TSL application range. Specify the SSL/TLS application range.	

### 1.4.6 Remove a certificate

In Administrator mode of PageScope Web Connection, select the Security tab - "SSL/TLS Setting" - "SSL / TLS Setting" - [Setup] - "Remove a Certificate".

If necessary, remove the certificate installed on this machine. To remove the installed certificate, click [OK].

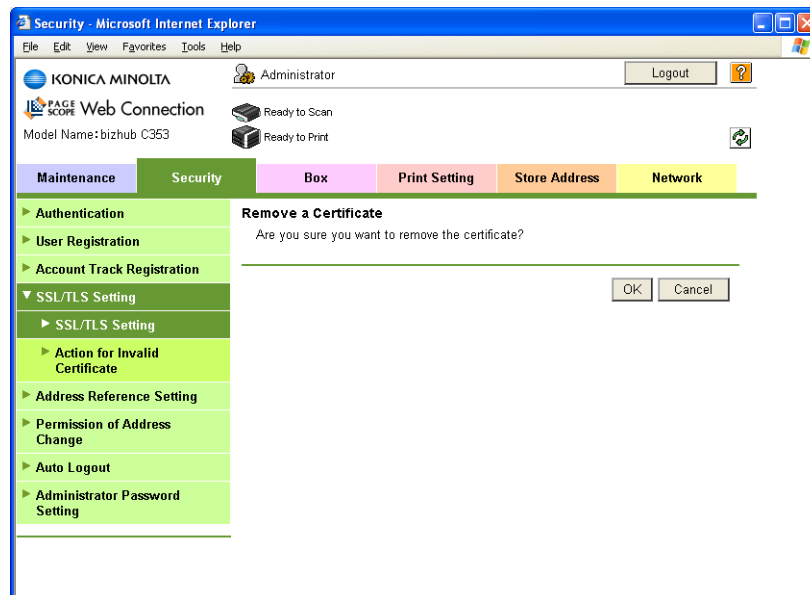

#### Detail

*If Enhanced Security Mode is set to "ON", the certificate cannot be removed.*

## 1.5 Acquiring the certificate for this machine

Acquire the certificate for this machine at the user side.

Download the created certificate for this machine by accessing this machine with PageScope Web Connection. Once the certificate for this machine is acquired, messages are encrypted based on the acquired certificate (public key), and then sent from the user to this machine.

Specify the settings according to the following flowchart.

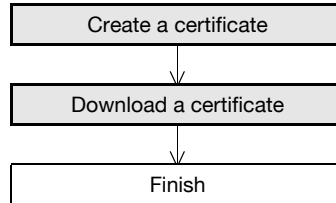

### Detail

Users can acquire the certificate for this machine by receiving a message with a digital signature attached from this machine. For details on sending E-Mails with the digital signature attached, refer to ["Sending scan data by E-mail \(With the digital signature attached\)"](#) on page 1-31.

### 1.5.1 Create a certificate

Create a certificate for this machine.

For details, refer to ["Creating a certificate for this machine for SSL-based communication"](#) on page 1-7.

### 1.5.2 Download a certificate

In Administrator mode of PageScope Web Connection, select the Security tab - "SSL/TLS Setting" - [Setup] - "Certificate Download".

To download a certificate to the computer, click [Download].

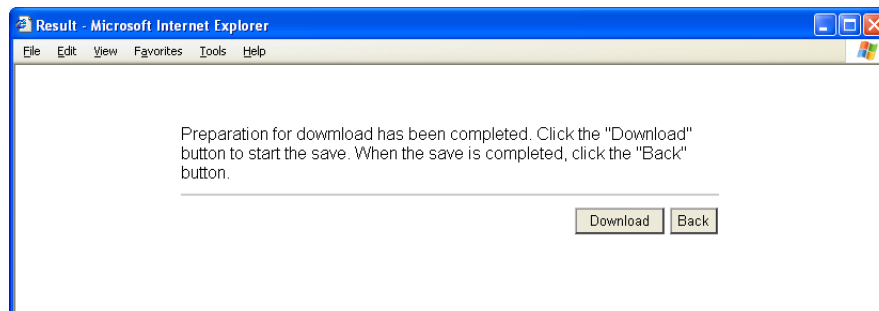

## 1.6 Registering a user certificate in this machine

Register a user certificate in this machine

When registering a certificate in this machine, the following methods are available: manual registration at the time of address registration and auto registration by sending a message with a digital signature attached. Once the certificate for this machine is registered, messages are encrypted based on the registered certificate, and then sent from the user to this machine.

Specify the settings according to the following flowchart.

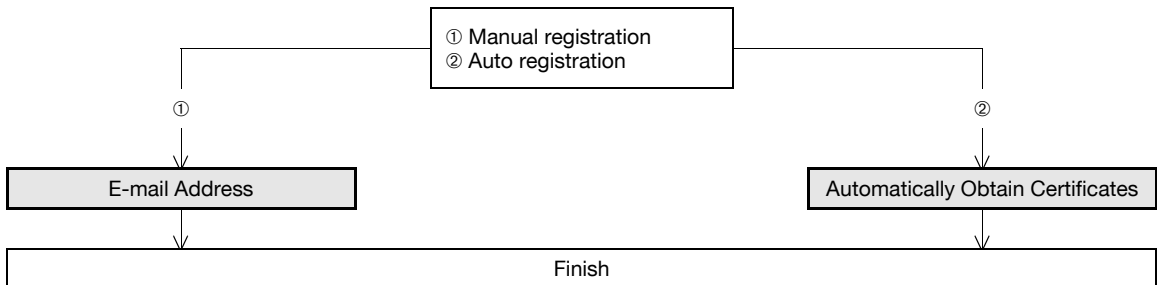

### 1.6.1 E-mail Address

In Administrator mode of PageScope Web Connection, select the Store Address tab - "Address Book" - "Store Address" - [New Registration] - "Address Book (E-mail)".

Specify the following setting.

The screenshot shows the 'Store Address - Microsoft Internet Explorer' window. The 'Store Address' tab is active, and the 'Address Book (E-mail)' section is expanded. The 'Registration of Certification Information' option is selected, and a red box highlights the 'Registration of Certification Information' section, which includes a text input field and a 'Browse...' button. The 'Deletion of Certification Information' option is also visible but not selected. The 'Limiting Access to Destinations' section is also visible at the bottom.

Item	Definition	Prior confirmation
Registration of Certification Information	Select the "Registration of Certification Information" check box. To specify a storage location of certification information to be registered, click [Browse]. Only files in the DER (Distinguished Encoding Rules) format are supported for certificate information. To delete the certificate information, select "Deletion of Certification Information".	Certificate storage location



**Reminder**

*If the E-mail address to be registered does not match the E-mail address of the certificate, the certificate cannot be registered. Confirm whether both E-mail addresses match, and then register the certificate.*

**1.6.2 Automatically Obtain Certificates**

In Administrator mode of PageScope Web Connection, select the Network tab - "E-mail Setting" - "S/MIME". Specify the following settings.

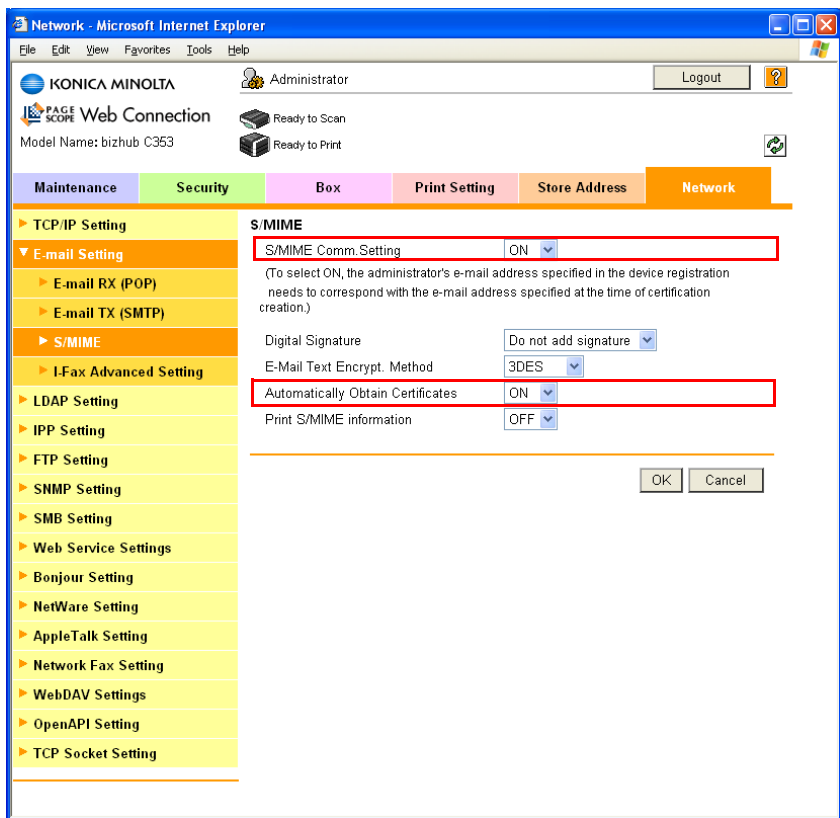

Item	Definition	Prior confirmation
S/MIME Comm. Setting	Select "ON".	
Automatically Obtain Certificates	Select "ON".	



**Detail**

*After specifying settings for "Automatically Obtain Certificates", register the E-mail address for which a certificate is to be registered in Address Book. After registering the E-mail address, send the message with a digital signature attached from the computer on the network to this machine. If the E-mail address registered in this machine matches the E-mail address of the received certificate, the certificate is automatically registered.*



## 1.7 Specifying the date and time on this machine

Specify the date and time of the internal clock of this machine.

The following specification methods are available: manual specification and acquisition from the NTP server via the network.

To use the fax function on this machine, specify the date and time of this machine in advance. Also, to make this machine log in to the Active Directory, it may be necessary to specify the date and time of this machine.

Specify the settings according to the following flowchart.

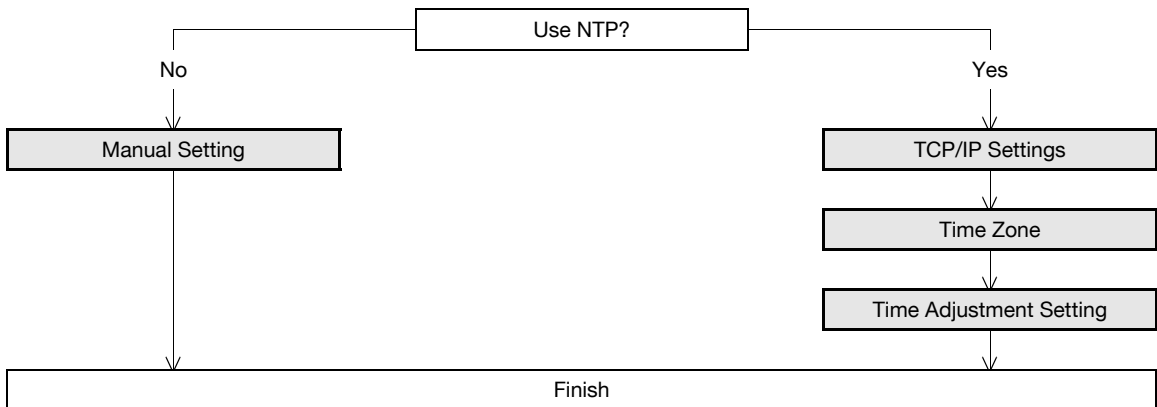

### Detail

The following sections contain descriptions on the settings to make this machine log in to the Active Directory. For details, refer to the respective sections.

["Searching for E-mail addresses from the LDAP server" on page 1-35](#)

["Limiting users using this machine \(Active Directory\)" on page 1-102](#)

### 1.7.1 Manual Setting

In Administrator mode of PageScope Web Connection, select the Maintenance tab - "Date/Time Setting" - "Manual Setting".

Specify the following settings.

Maintenance - Microsoft Internet Explorer

KONICA MINOLTA Administrator Logout

PageScope Web Connection Ready to Scan Ready to Print

Model Name: bizhub C353

Maintenance Security Box Print Setting Store Address Network

Manual Setting

Date

Year: 2007

Month: 9

Day: 12

Time

Hour: 10

Minute: 54

Time Zone: GMT 0:00

Daylight Saving Time (1-150)

OK Cancel

Item	Definition	Prior confirmation
Year	Enter the year.	
Month	Enter the month.	
Day	Enter the day.	
Hour	Enter the hour.	
Minute	Enter the minutes.	
Time Zone	Select the time difference from GMT.	Time zone
Daylight Saving Time	If necessary, specify the daylight saving time setting.	

### 1.7.2 TCP/IP Settings

Specify settings to use this machine in a TCP/IP network environment.

For details, refer to "[Specifying general settings for TCP/IP-based communication](#)" on page 1-2.

### 1.7.3 Time Zone

On the Manual Setting screen, specify setting for "Time Zone".

For details, refer to "[Manual Setting](#)" on page 1-16.

### 1.7.4 Time Adjustment Setting

In Administrator mode of PageScope Web Connection, select the Maintenance tab - "Date/Time Setting" - "Time Adjustment Setting".

Specify the following settings.

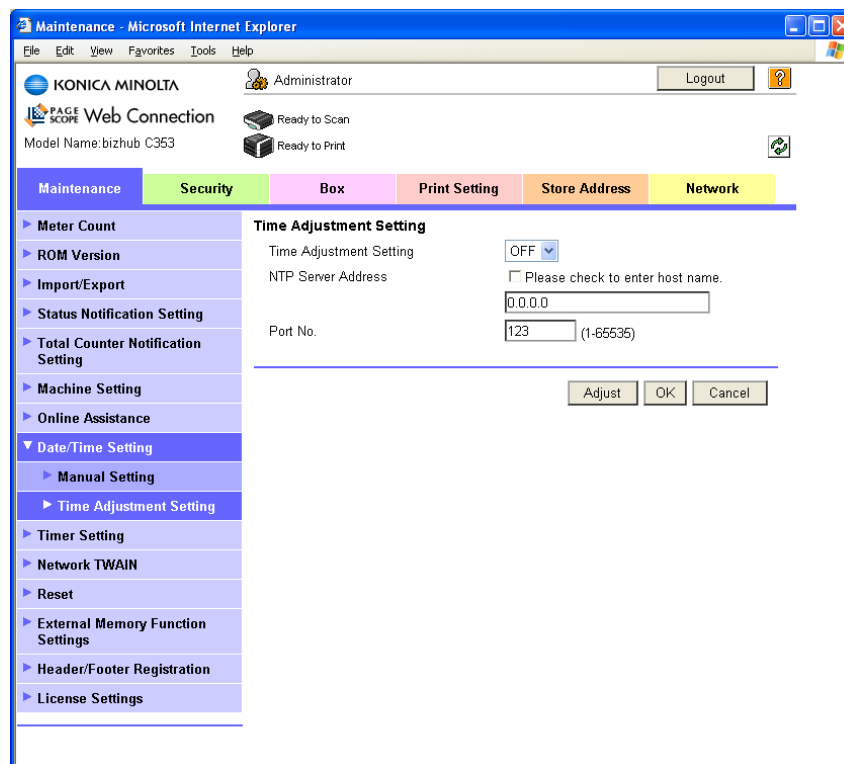

Item	Definition	Prior confirmation
Time Adjustment Setting	Select "ON".	
NTP Server Address	Specify the NTP server address. (Format: "****.***.***.***", Range for ***: 0 to 255) If the DNS server is specified, the address can be specified using the host name. This item can also be specified with IPv6.	Address of the server

Item	Definition	Prior confirmation
Port Number	Default setting: 123 Specify the port number.	Port number for the server
[Adjust]	Connects to the NTP server with the specified conditions to adjust the time.	

## 1.8 Sending scan data to a Windows computer

Specify settings for sending scan data to a Windows computer.

Scan data can be sent directly to a computer specified on the network. In order to perform a Scan to PC (SMB) operation, first specify shared file settings in Windows on the computer receiving the data.

To specify a computer on another network using Windows name (NetBIOS name), a WINS server must be used.

This machine supports the direct hosting service. To send data in the IPv6 environment, the Direct Hosting setting must be enabled. When the Direct Hosting setting is enabled, the destination computer can be specified using the IPv6 address or the computer (host) name. When the destination is specified with the computer (host) name, this machine uses the DNS server to acquire the IPv6 address.

Specify the settings according to the following flowchart.

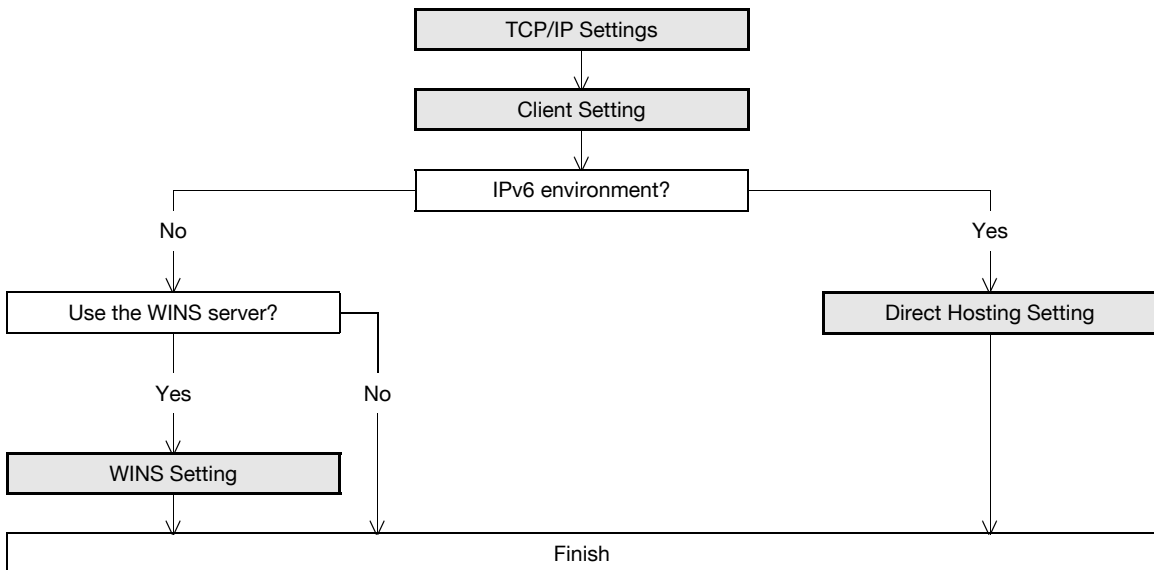

### Note

For details on registering SMB addresses, refer to ["Registering or editing an address book destination" on page 1-155](#).

For details on the SMB-based file transmission, refer to the User's Guide [Network Scan/Fax/Network Fax Operations].

### 1.8.1 TCP/IP Settings

Specify settings to use this machine in a TCP/IP network environment.

To send data in the IPv6 environment, the Direct Hosting setting must be enabled. To specify the destination computer with the computer (host) name, prepare a DNS server and be sure to specify the DNS settings of this machine correctly.

For details, refer to ["Specifying general settings for TCP/IP-based communication" on page 1-2](#).

## 1.8.2 Client Setting

In Administrator mode of PageScope Web Connection, select the Network tab - "SMB Setting" - "Client Setting".

Specify the following settings.

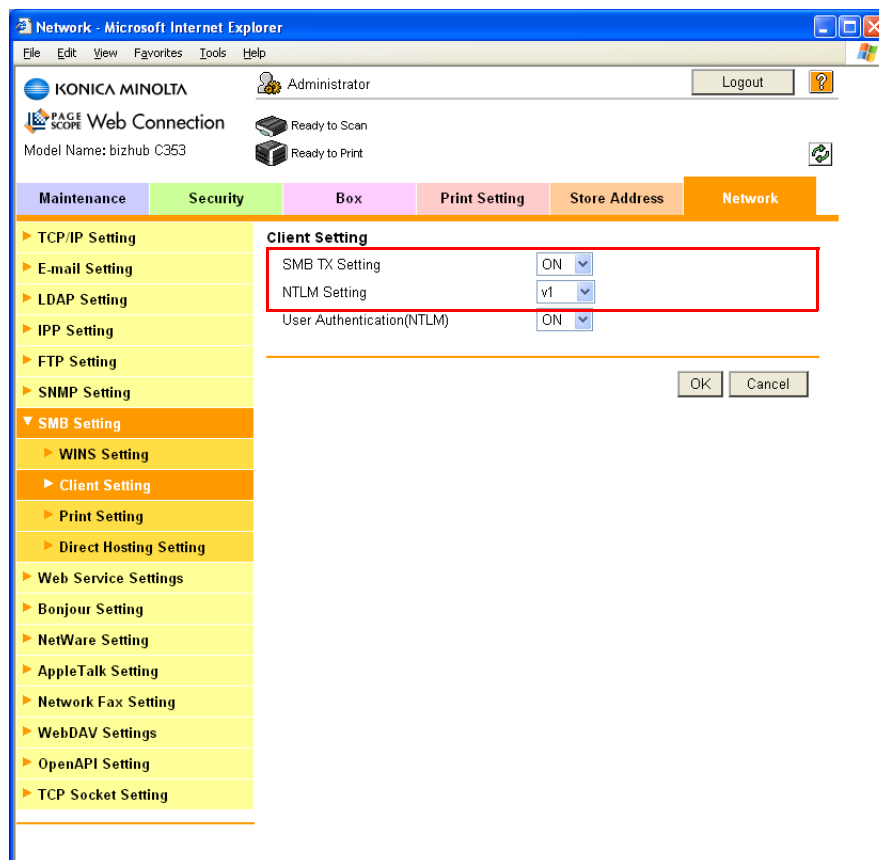

Item	Definition	Prior confirmation
SMB TX Setting	Select "ON".	
NTLM Setting	Specify the NTLM version. To perform SMB TX to Mac OSX, Samba (Linux/Unix), specify "v1". To perform SMB TX to Windows 98SE/Windows Me, specify "v1/v2" or "v1".	Destination OS

### 1.8.3 Direct Hosting Setting

In Administrator mode of PageScope Web Connection, select the Network tab - "SMB Setting" - "Direct Hosting Setting".

Specify the following setting.

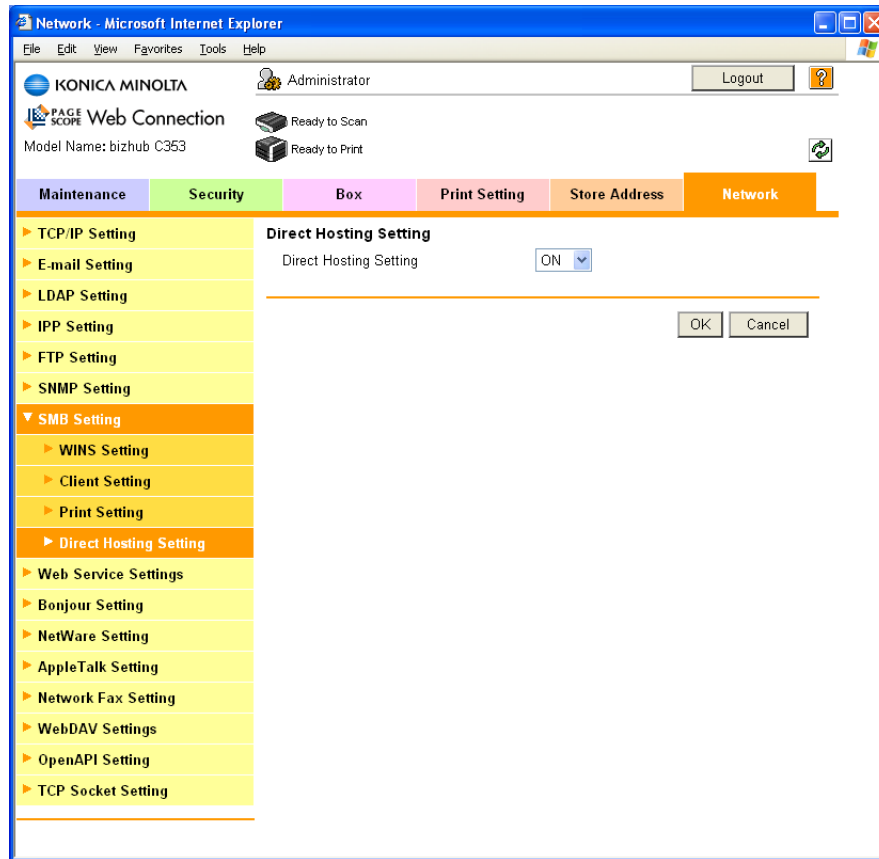

Item	Definition	Prior confirmation
Direct Hosting Setting	To use the direct hosting service, select "ON". To communicate with the destination using an IPv6 address, select "ON".	Whether the IPv6 environment is available

## 1.8.4 WINS Setting

In Administrator mode of PageScope Web Connection, select the Network tab - "SMB Setting" - "WINS Setting".

Specify the following settings.

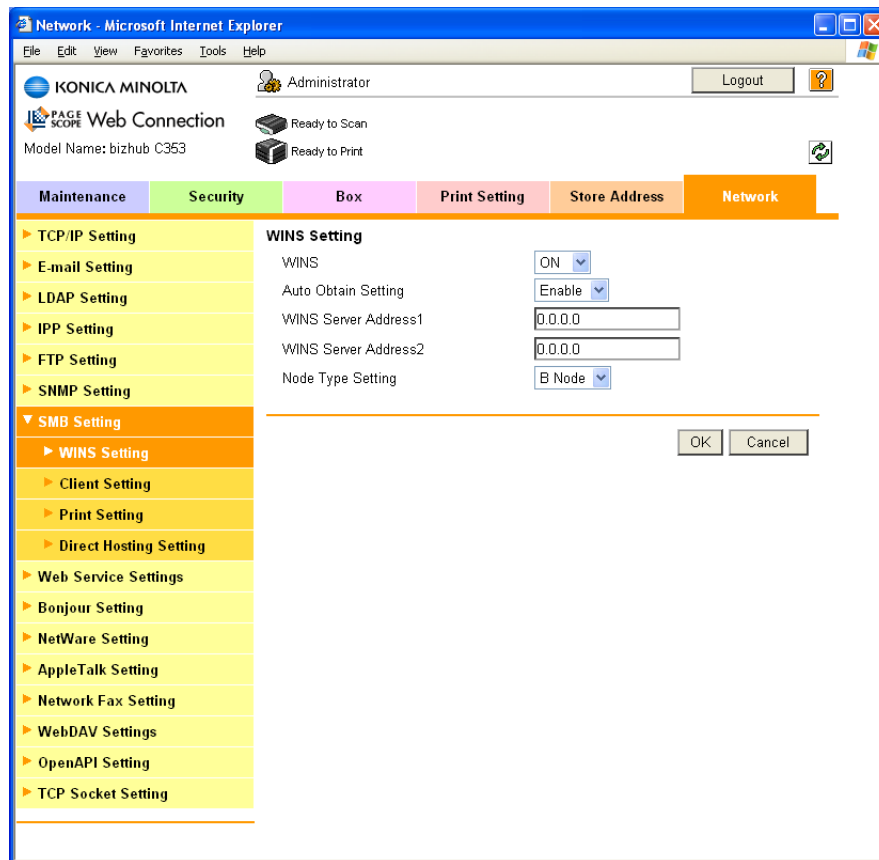

Item	Definition	Prior confirmation
WINS	To use the WINS server, select "ON".	
Auto Obtain Setting	To automatically obtain the WINS server address, select "Enable". This item is enabled when the DHCP is enabled.	Whether automatic acquisition is available with DHCP
WINS Server Address 1 and 2	Specify the WINS server address. (Format: "****.***.***.***", Range for ***: 0 to 255)	Address of the server
Node Type Setting	Specify the name resolution method. <ul style="list-style-type: none"> <li>B Node: Query by broadcast</li> <li>P Node: Query to WINS server</li> <li>M Node: Query in the order of broadcast, then WINS server</li> <li>H Node: Query in the order of WINS server, then broadcast</li> </ul>	

## 1.9 Sending scan data by E-mail

Specify settings for sending scan data by E-mail.

Scan data can be sent to a specified E-mail address as an attached file of the message.

If the SMTP server supports SMTP over SSL or STARTTLS, setting is recommended. Because communication can be encrypted by SSL/TLS, the machine can communicate securely with the server.

If the SMTP server requires SMTP authentication, the SMTP authentication setting must be specified.

If the SMTP server requires POP before SMTP authentication, the POP before SMTP authentication setting must be specified. In addition, if the POP server supports POP over SSL or APOP authentication, settings for these can be specified.

Specify the settings according to the following flowchart.

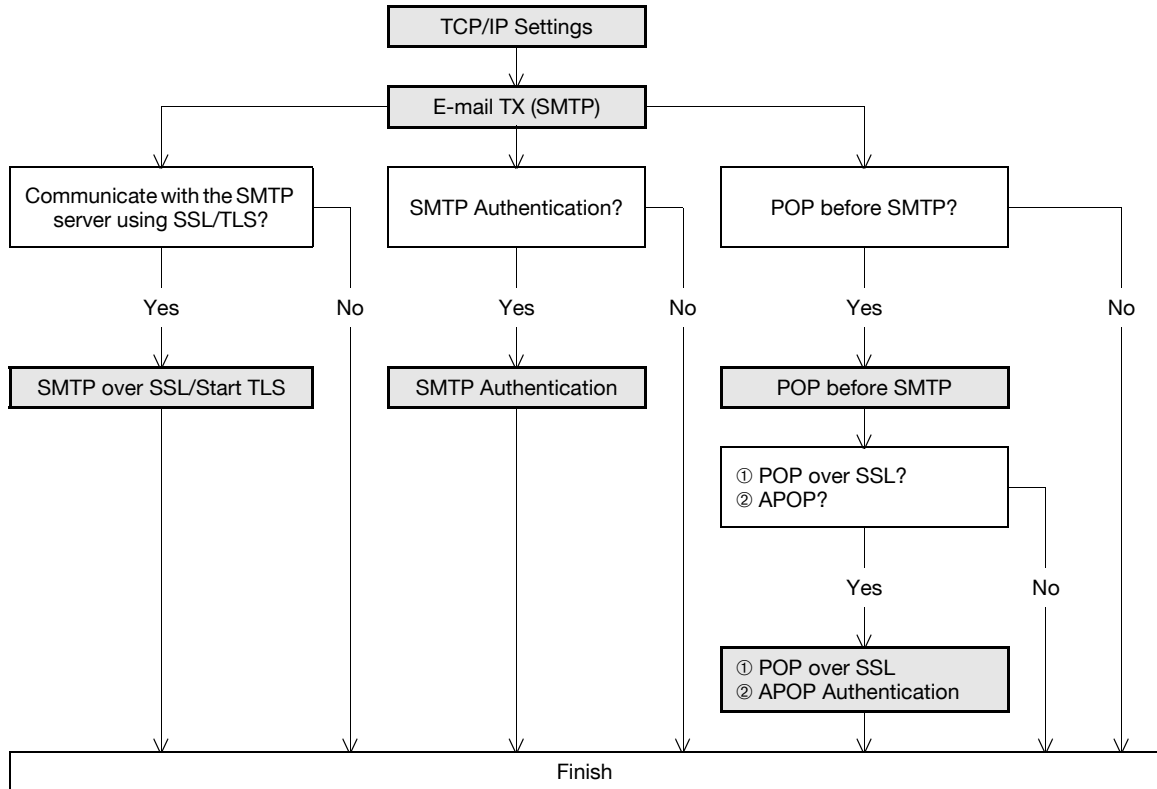

### Note

For details on registering E-mail addresses, refer to "[Registering or editing an address book destination](#)" on page 1-155.

For details on the E-mail-based file transmission, refer to the User's Guide [Network Scan/Fax/Network Fax Operations].

### 1.9.1 TCP/IP Settings

Specify settings to use this machine in a TCP/IP network environment.

For details, refer to "[Specifying general settings for TCP/IP-based communication](#)" on page 1-2.



## 1.9.2 E-mail TX (SMTP)

### E-mail TX (SMTP)

In Administrator mode of PageScope Web Connection, select the Network tab - "E-mail Setting" - "E-mail TX (SMTP)".

Specify the following settings.

The screenshot shows the 'E-mail TX (SMTP)' configuration page in the PageScope Web Connection Administrator. The settings are as follows:

- E-mail TX Setting
- Scan to E-mail: ON
- E-mail Notification: ON
- Total Counter Notification: ON
- SMTP Server Address: 0.0.0.0 (Please check to enter host name.)
- Use SSL/TLS: OFF
- Port Number: 25 (1-65535)
- Port No. (SSL): 465 (1-65535)
- Connection Timeout: 60 sec.
- Max Mail Size: No Limit
- Server Capacity: (empty) Mbyte(1-100)
- Admin. E-mail Address: admin@co.jp
- Device Mail Address: (empty)
- Authentication Setting:
  - POP before SMTP: OFF
  - POP before SMTP Time: 5 sec. (0-60)
  - SMTP Authentication
    - User ID: (empty)
    - Password: (empty)
    - Domain Name: (empty)
- Binary Division
  - Divided Mail Size: (empty) Kbyte (100-15000; Step100)

Item	Definition	Prior confirmation
E-mail TX Setting	Select the "E-mail TX Setting" check box.	
Scan to E-mail	Select "ON".	
SMTP Server Address	Specify the SMTP server address. (Format: "****.***.***.***", Range for ***: 0 to 255) If the DNS server is specified, the address can be specified using the host name. This item can also be specified with IPv6.	Address of the server
Port Number	Default setting: 25 Specify the port number.	Port number for the server
Connection Timeout	Specify the time period before the server connection times out.	
Max Mail Size	Select whether to limit the size of sent messages.	
Server Capacity	To limit the maximum mail size, specify the max. allowance of the mail size including the attached file. Mails exceeding the maximum allowance are removed. If a mail is separated, this setting is disabled.	Receiving limit of the server

Item	Definition	Prior confirmation
Admin. E-mail Address	The administrator address specified in "Machine Setting" in the Maintenance tab in Administrator mode of PageScope Web Connection is displayed.	
Binary Division	To divide an E-Mail, select the "Binary Division" check box. If the mail software used for receiving mails does not have the mail restore function, the mails may not be read.	Restore function of the mail soft
Divided Mail Size	To divide the mail, specify a divided mail size.	Receiving limit of the server

### Admin. E-mail Address

In Administrator mode of PageScope Web Connection, select the Maintenance tab - "Machine Setting". Specify the administrator address.

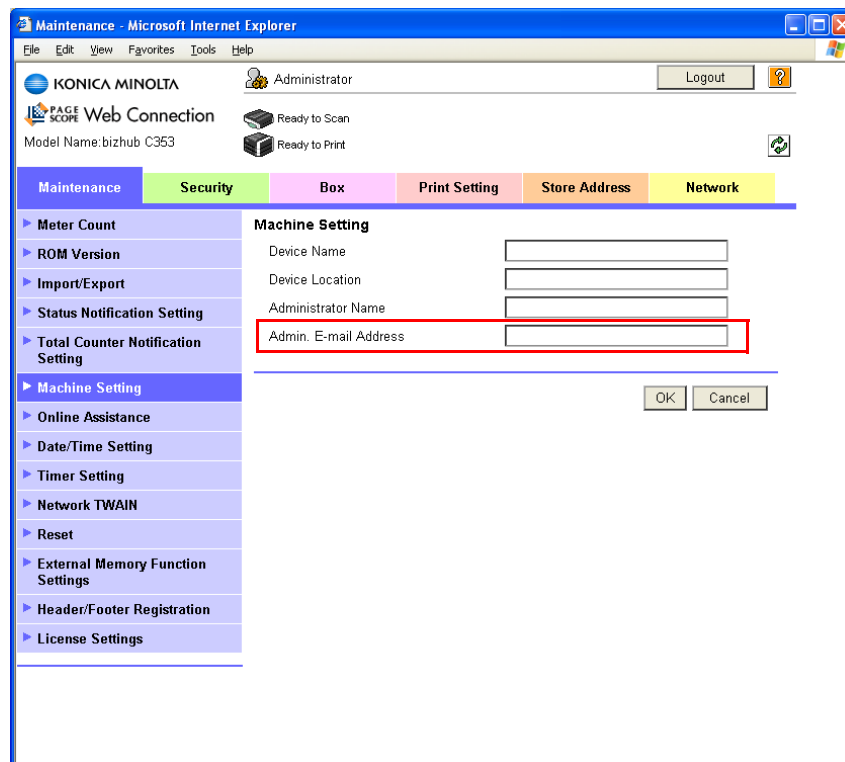

Item	Definition	Prior confirmation
Admin. E-mail Address	Specify the address for the administrator (up to 128 characters). If the administrator address is not set, messages cannot be sent. The set address is displayed on the transmitter section of the message. Before messages are sent, the address can be changed to one other than the administrator address from the control panel.	Address for the administrator



#### Detail

If "Change the From Address" is set to "Restrict", the From address cannot be changed when sending an E-Mail message. For details, refer to the User's Guide [Network Scan/Fax/Network Fax Operations].

### 1.9.3 SMTP over SSL/Start TLS

#### E-mail TX (SMTP)

In Administrator mode of PageScope Web Connection, select the Network tab - "E-mail Setting" - "E-mail TX (SMTP)".

Specify the following settings.

Item	Definition	Prior confirmation
Use SSL/TLS	To encrypt communication between this machine and the SMTP server using SSL/TTS, select "SMTP over SSL" or "Start TLS".	Whether the sever supports SSL or STARTTLS
Port Number	Default setting: 25 If "Start TLS" is selected, specify the port number.	Port number for the server
Port No. (SSL)	Default setting: 465 If "SMTP over SSL" is selected, specify the port number to be used for SSL communication.	Port number for the server

#### Action for Invalid Certificate

In Administrator mode of PageScope Web Connection, select the Security tab - "SSL/TLS Setting" - "Action for Invalid Certificate".

Specify the following settings.

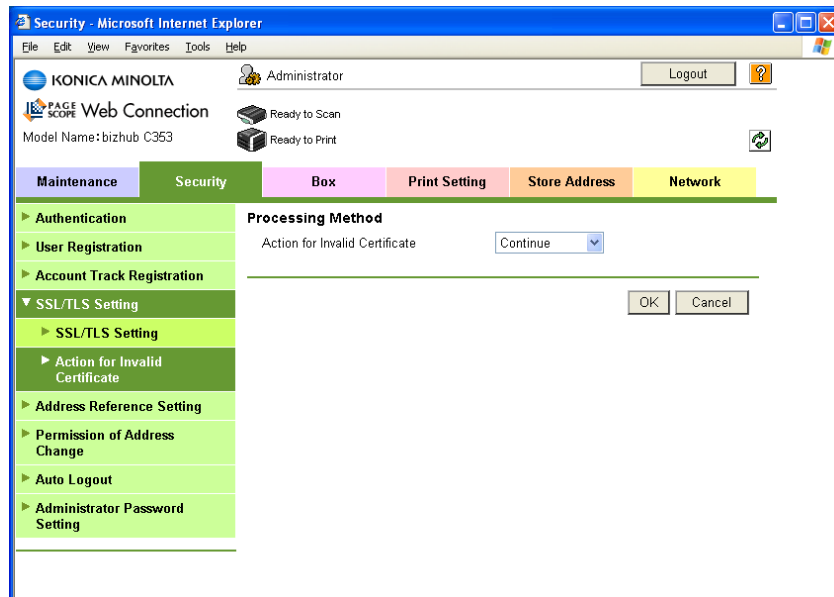

Item	Definition	Prior confirmation
Action for Invalid Certificate	Specify the operation when the validity period for the received certificate has expired. If "Continue" is selected, processing continues even if the date of the certificate is invalid. If "Delete the Job" is selected, the job is deleted if the date of the certificate is invalid.	

### 1.9.4 SMTP Authentication

In Administrator mode of PageScope Web Connection, select the Network tab - "E-mail Setting" - "E-mail TX (SMTP)".

Specify the following settings.

Item	Definition	Prior confirmation
SMTP Authentication	To perform SMTP authentication, select the "SMTP Authentication" check box.	Whether the sever requests SMTP
User ID	Specify the user ID for the SMTP authentication (up to 255 characters).	
Password	Specify the password for the SMTP authentication (up to 128 characters).	
Domain Name	Specify the domain name for the SMTP authentication (up to 255 characters). If the authentication method is Digest-MD5, the domain name must be specified.	Authentication method
Authentication Settings	Specify whether to synchronize with user authentication. When user authentication is performed, this item is displayed.	Whether to synchronize the user authentication



#### Detail

*A SMTP authentication method that is supported by the SMTP server and provided with the strongest encryption strength is automatically selected from Digest-MD5, CRAM-MD5, PLAIN, and LOGIN.*

*If there is just one domain (realm) to which the user belongs, it is notified from the SMTP server at the time of initial communication, and communication is automatically made using the domain name. Therefore, no domain name setting on this machine is not required. If there are two domains or more to which the user belongs, however, specify the domain name to which the user belongs.*

### 1.9.5 POP before SMTP

#### POP before SMTP

In Administrator mode of PageScope Web Connection, select the Network tab - "E-mail Setting" - "E-mail TX (SMTP)".

Specify the following settings.

Item	Definition	Prior confirmation
POP before SMTP	To perform POP before SMTP, select "ON".	Whether the sever requires POP before SMTP authentication
POP before SMTP Time	Specify the time period to access the SMTP server after logging in to the POP server.	Whether the POP server is different from the SMTP server



#### Detail

*If the POP server is different from the SMTP server, the POP server informs the SMTP server that it has been logged in. Therefore, if the set POP before SMTP time is too short, messages may not be sent.*

## E-mail RX (POP)

In Administrator mode of PageScope Web Connection, select the Network tab - "E-mail Setting" - "E-mail RX (POP)".

Specify the following settings.

The screenshot shows the 'E-mail RX (POP)' configuration page in the PageScope Web Connection Administrator. The left sidebar lists various settings categories, with 'E-mail RX (POP)' selected. The main content area contains the following settings:

- E-mail RX Setting: ON
- POP Server Address: 0.0.0.0 (with a checkbox for 'Please check to enter host name.')
- Login Name: [Empty text box]
- Password: [Empty text box]
- APOP Authentication: OFF
- MDN Response: ON
- Connection Timeout: 30 sec.
- Port Number: 110 (1-65535)
- Use SSL/TLS: [Unchecked]
- Port No.(SSL): 995 (1-65535)
- Check for New Messages: [Unchecked]
- Polling Interval: 15 min. (1-60)

Buttons for 'OK' and 'Cancel' are located at the bottom right of the settings area.

Item	Definition	Prior confirmation
E-mail RX Setting	To perform POP before SMTP, select "ON".	
POP Server Address	Specify the POP server address. (Format: "****.***.***.***", Range for ***: 0 to 255) If the DNS server is specified, the address can be specified using the host name. This item can also be specified with IPv6.	Address of the server
Login Name	Enter the login name for the POP server (up to 63 characters).	
Password	Specify the password for logging in to the POP server (up to 15 characters).	
Connection Timeout	Specify the time period before the server connection times out.	
Port Number	Default setting: 110 Specify the port number.	Port number for the server

## 1.9.6 POP over SSL

### E-mail RX (POP)

In Administrator mode of PageScope Web Connection, select the Network tab - "E-mail Setting" - "E-mail RX (POP)".

Specify the following settings.

Item	Definition	Prior confirmation
Use SSL/TLS	To encrypt communication between this machine and the POPS server using SSL, select the "Use SSL/TLS" check box.	Whether the sever supports SSL
Port No. (SSL)	Default setting: 995 Specify the port number used in SSL communication.	Port number for the server

### Action for Invalid Certificate

In Administrator mode of PageScope Web Connection, select the Security tab - "SSL/TLS Setting" - "Action for Invalid Certificate".

Specify the following settings.

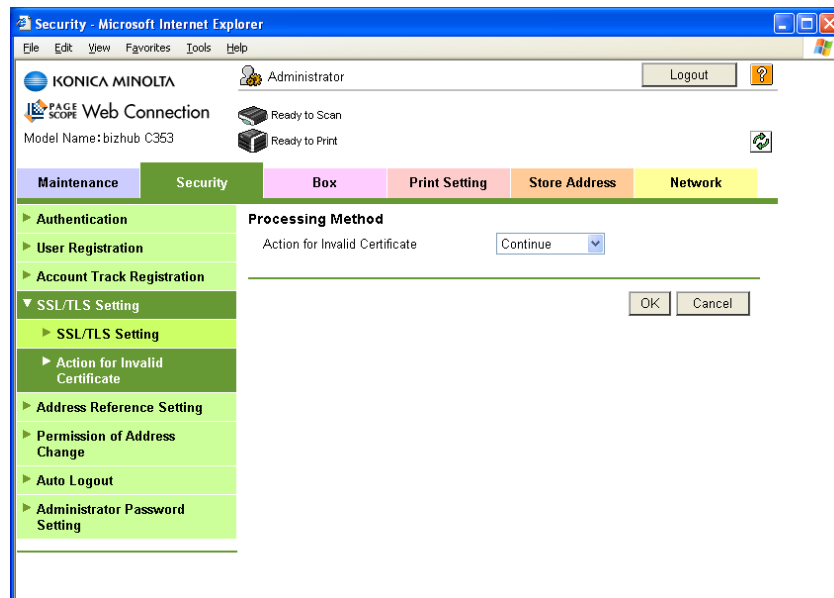

Item	Definition	Prior confirmation
Action for Invalid Certificate	Specify the operation when the validity period for the received certificate has expired. If "Continue" is selected, processing continues even if the date of the certificate is invalid. If "Delete the Job" is selected, the job is deleted if the date of the certificate is invalid.	

## 1.9.7 APOP Authentication

In Administrator mode of PageScope Web Connection, select the Network tab - "E-mail Setting" - "E-mail RX (POP)".

Specify the following settings.

Item	Definition	Prior confirmation
APOP Authentication	To encrypt the login name and password when logging in to the POP server, select "ON".	Whether the sever re-requests APOP



### Detail

*When the POP server is logged in with APOP, the password is encrypted with Digest-MD5. If "ON" is specified for APOP authentication, you cannot log in to the server if the POP server does not support APOP.*

## 1.10 Sending scan data by E-mail (With the digital signature attached)

Specify settings for sending scan data by E-mail with the digital signature attached.

When scan data is sent by E-mail, it can be sent with the digital signature attached.

The certificate for this machine can be sent to the user by sending a message with the digital signature attached. Users can encrypt the message to send to this machine using the received certificate.

Communication by combining POP before SMTP, APOP, SMTP authentication or encryption using SSL/TLS is available. For details, refer to ["Sending scan data by E-mail" on page 1-23](#).

Specify the settings according to the following flowchart.

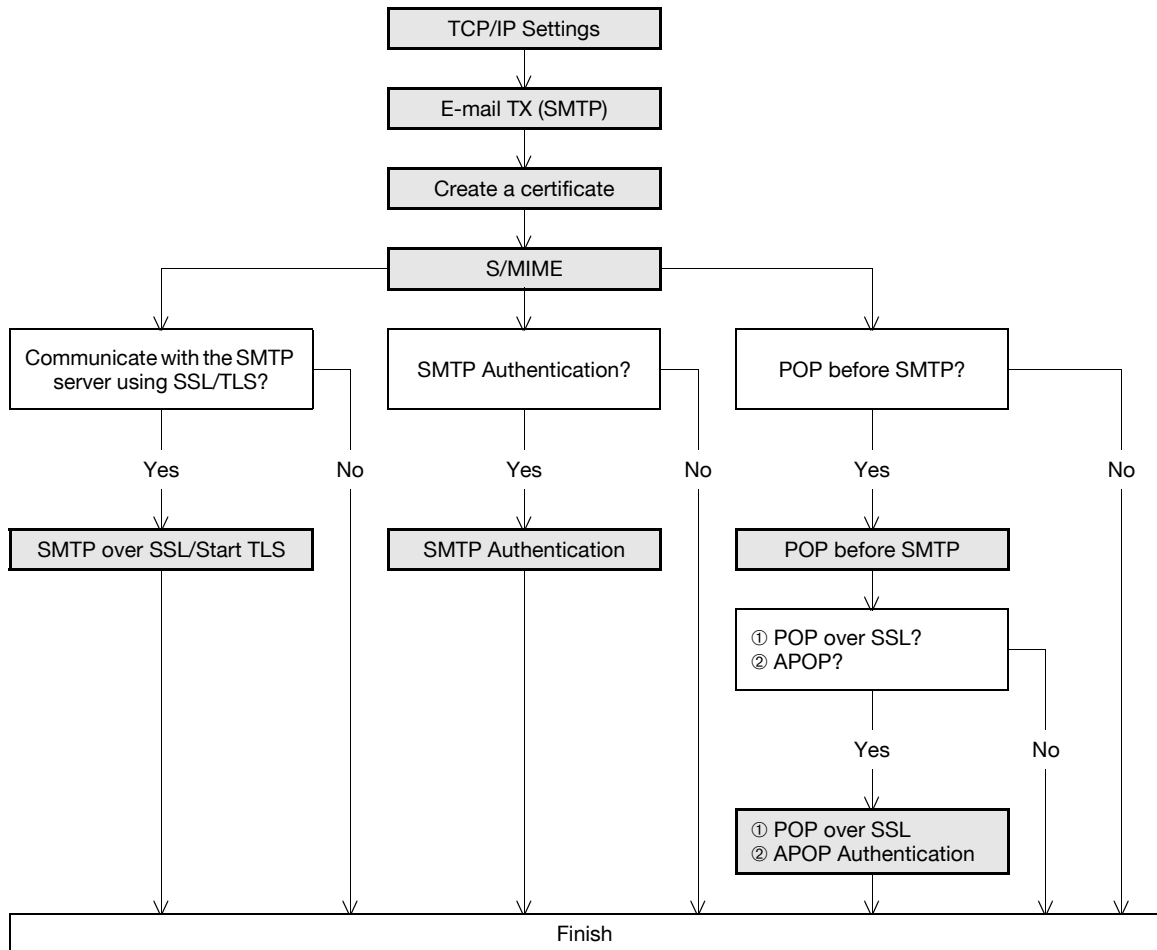

### 1.10.1 TCP/IP Settings

Specify settings to use this machine in a TCP/IP network environment.

For details, refer to ["Specifying general settings for TCP/IP-based communication" on page 1-2](#).

### 1.10.2 E-mail TX (SMTP)

Specify settings for sending messages.

For details, refer to ["E-mail TX \(SMTP\)" on page 1-24](#).

### 1.10.3 Create a certificate

Create a certificate for this machine.

For details, refer to ["Creating a certificate for this machine for SSL-based communication" on page 1-7](#).



### 1.10.4 S/MIME

In Administrator mode of PageScope Web Connection, select the Network tab - "E-mail Setting" - "S/MIME". Specify the following settings.

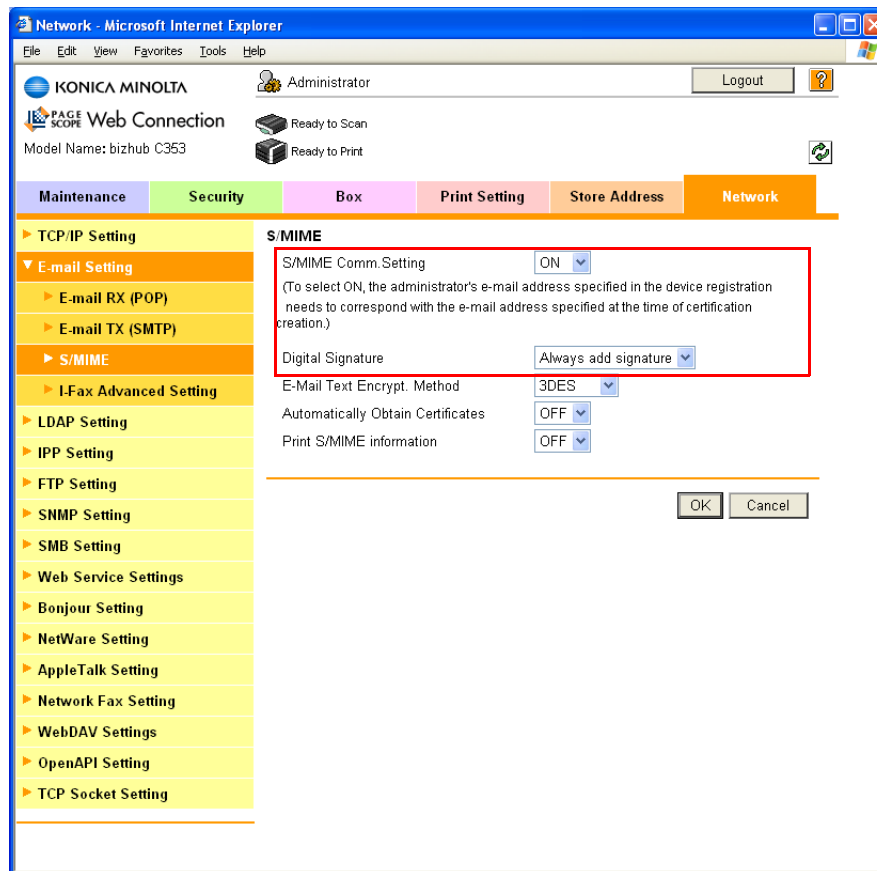

Item	Definition	Prior confirmation
S/MIME Comm. Setting	Select "ON".	
Digital Signature	Select "Always add signature" or "Select when sending".	

### 1.10.5 SMTP over SSL/Start TLS

Specify the settings for SMTP over SSL/Start TLS.

For details, refer to ["SMTP over SSL/Start TLS" on page 1-26](#).

### 1.10.6 SMTP Authentication

Specify the settings for SMTP authentication.

For details, refer to ["SMTP Authentication" on page 1-27](#).

### 1.10.7 POP before SMTP

Specify the settings for POP before SMTP.

For details, refer to ["POP before SMTP" on page 1-27](#).

### 1.10.8 POP over SSL

Specify the settings for POP over SSL.

For details, refer to ["POP over SSL" on page 1-29](#).

### 1.10.9 APOP Authentication

Specify the settings for APOP authentication.

For details, refer to ["APOP Authentication" on page 1-30](#).

## 1.11 Sending scan data by E-mail (Public key-based encryption)

Specify settings for sending scan data as a message encrypted by public keys.

When scan data is sent by E-mail, the scan data can be sent by encrypting it using the user certificate registered in this machine in advance.

Sending encrypted messages prevents disclosure of information to third parties on the transmission path. In addition, if the message is encrypted by attaching the digital signature, authentication of this machine and message is possible. For details on attaching the digital signature to messages, refer to ["Sending scan data by E-mail \(With the digital signature attached\)" on page 1-31](#).

Communication by combining POP before SMTP, APOP, SMTP authentication or encryption using SSL/TLS is available. For details, refer to ["Sending scan data by E-mail" on page 1-23](#).

Specify the settings according to the following flowchart.

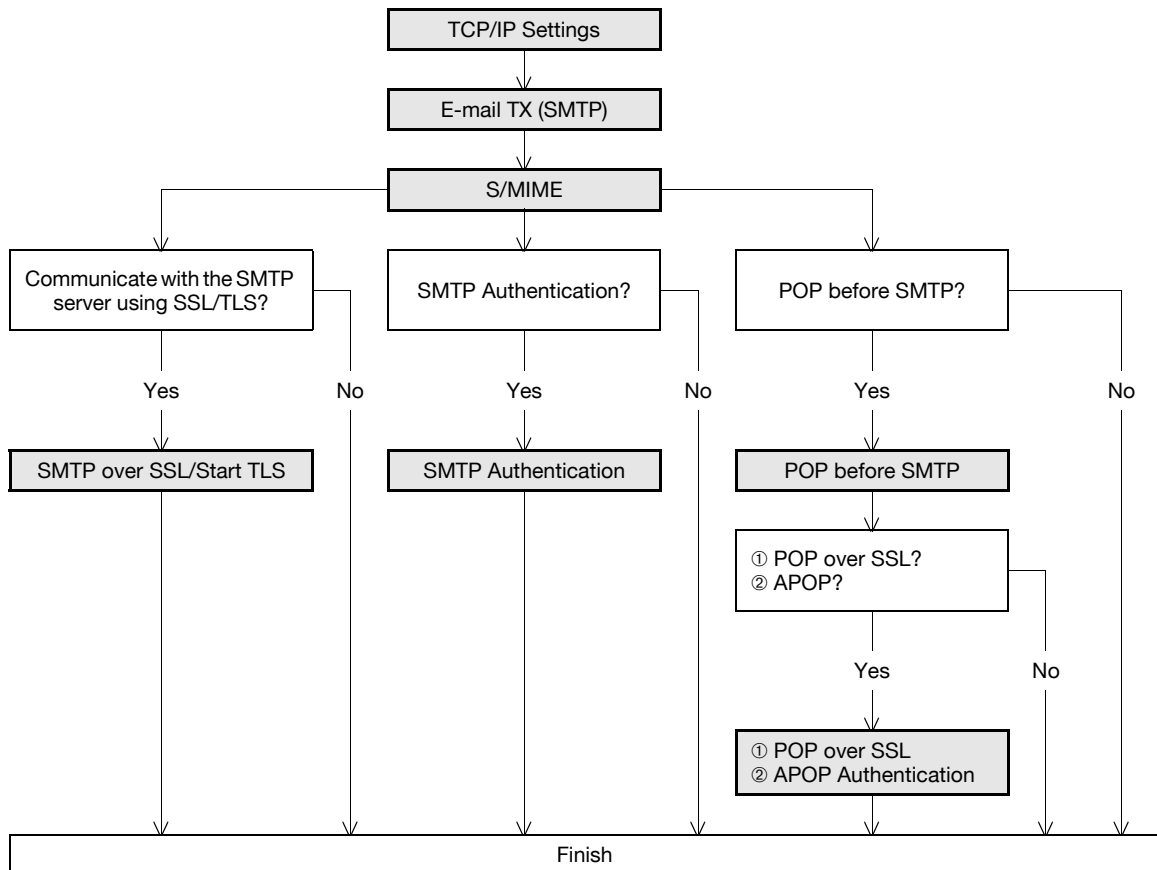

### Detail

Addresses for which no certificate is registered are not selectable. To encrypt messages for sending, register the user certificate in this machine in advance. For details, refer to ["Registering a user certificate in this machine" on page 1-14](#).

### 1.11.1 TCP/IP Settings

Specify settings to use this machine in a TCP/IP network environment.

For details, refer to ["Specifying general settings for TCP/IP-based communication" on page 1-2](#).

### 1.11.2 E-mail TX (SMTP)

Specify settings for sending messages.

For details, refer to ["E-mail TX \(SMTP\)" on page 1-24](#).

### 1.11.3 S/MIME

In Administrator mode of PageScope Web Connection, select the Network tab - "E-mail Setting" - "S/MIME". Specify the following settings.

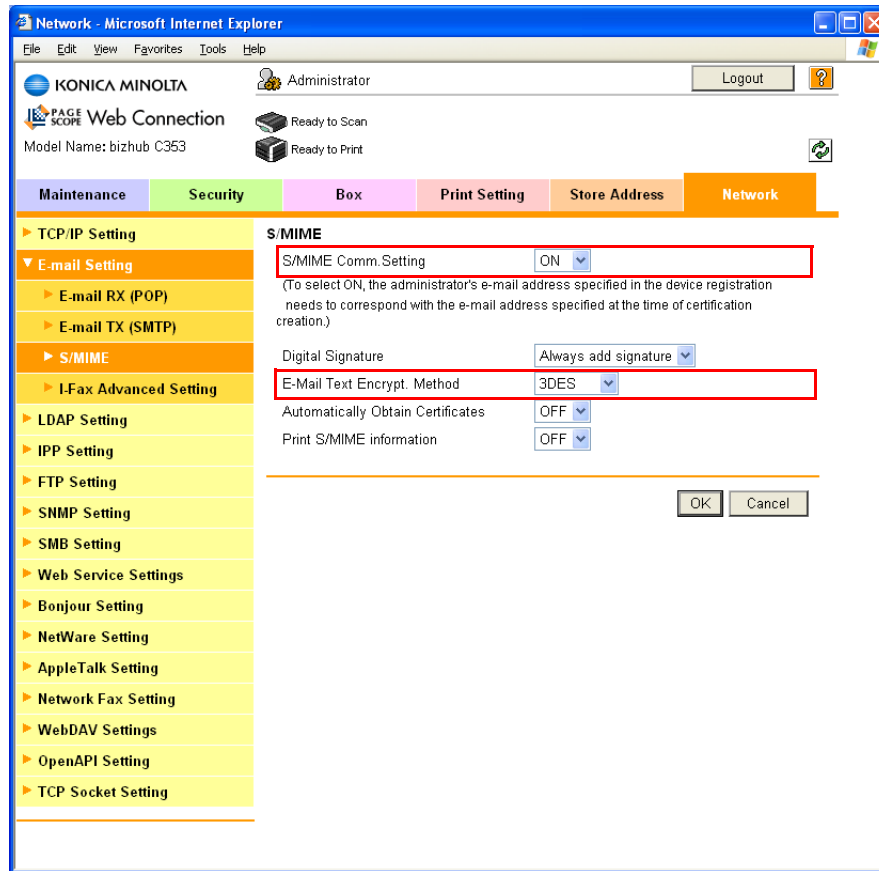

Item	Definition	Prior confirmation
S/MIME Comm. Setting	Select "ON".	
E-Mail Text Encrypt. Method	Specify the encryption type for the body of E-mail messages.	

### 1.11.4 SMTP over SSL/Start TLS

Specify the settings for SMTP over SSL/Start TLS.

For details, refer to ["SMTP over SSL/Start TLS" on page 1-26](#).

### 1.11.5 SMTP Authentication

Specify the settings for SMTP authentication.

For details, refer to ["SMTP Authentication" on page 1-27](#).

### 1.11.6 POP before SMTP

Specify the settings for POP before SMTP.

For details, refer to ["POP before SMTP" on page 1-27](#).

### 1.11.7 POP over SSL

Specify the settings for POP over SSL.

For details, refer to ["POP over SSL" on page 1-29](#).

### 1.11.8 APOP Authentication

Specify the settings for APOP authentication.

For details, refer to ["APOP Authentication" on page 1-30](#).

## 1.12 Searching for E-mail addresses from the LDAP server

Specify settings for searching for E-mail addresses from the LDAP server.

If the LDAP server is being for user management, the LDAP server can be accessed for searching for E-mail addresses. If this setting is specified, the [Address Search (LDAP)] key is displayed on the control panel. Using the LDAP server when specifying addresses saves trouble of registering addresses in this machine.

Also, to specify Active Directory as the LDAP server and select "GSS-SPNEGO" as the authentication method, be sure to specify a DNS server synchronized with Active Directory in the DNS Server Settings of this machine, and specify the date and time of this machine.

Specify the settings according to the following flowchart.

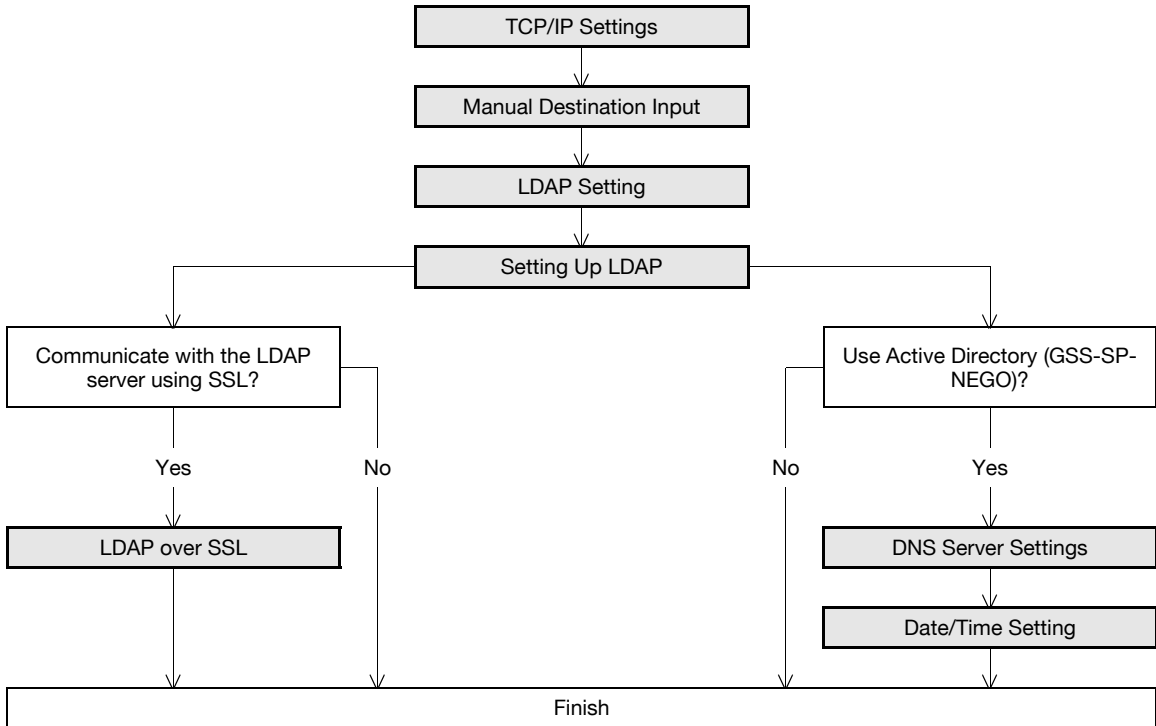

### Note

For details on the LDAP search-based transmission method, refer to the User's Guide [Network Scan/Fax/Network Fax Operations].

### 1.12.1 TCP/IP Settings

Specify settings to use this machine in a TCP/IP network environment.

For details, refer to "[Specifying general settings for TCP/IP-based communication](#)" on page 1-2.

### 1.12.2 Manual Destination Input

On the Administrator Settings screen of the control panel, select [Security Settings] - [4 Security Details] - [Manual Destination Input].

Specify the following settings.



### Note

For details on displaying the Network Setting screen, refer to "[Displaying the Network Settings screen](#)" on page 2-2.

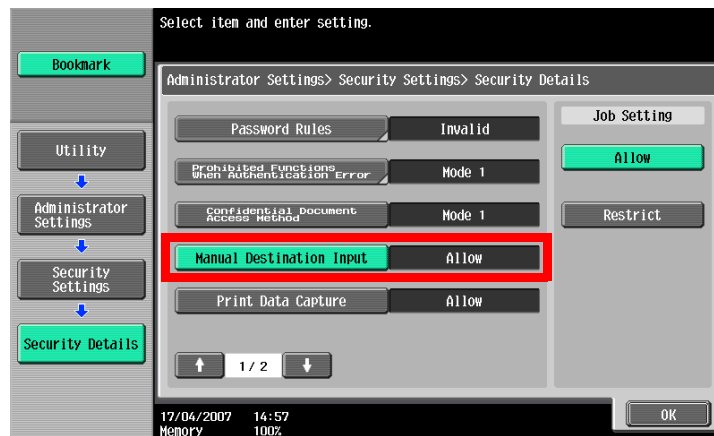

Item	Definition	Prior confirmation
Manual Destination Input	Select [Allow].	

### 1.12.3 LDAP Setting

In Administrator mode of PageScope Web Connection, select the Network tab - "LDAP Setting" - "LDAP Setting".

Specify the following setting.

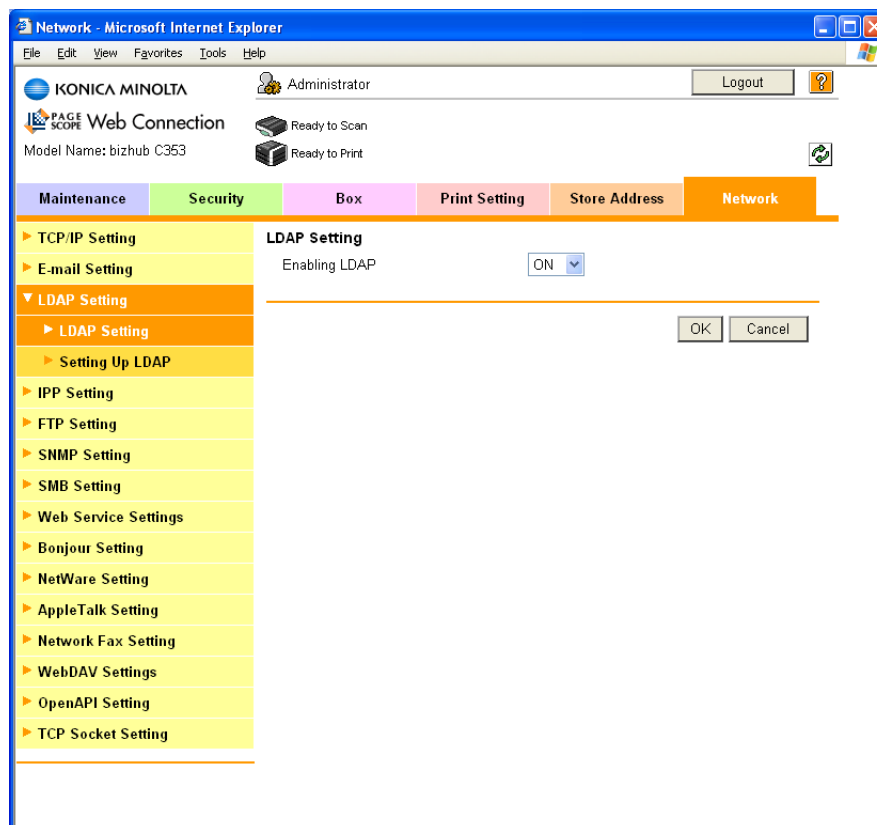

Item	Definition	Prior confirmation
Enabling LDAP	Select "ON".	

### 1.12.4 Setting Up LDAP

In Administrator mode of PageScope Web Connection, select the Network tab - "LDAP Setting" - "Setting Up LDAP" - [Edit].

Specify the following settings.

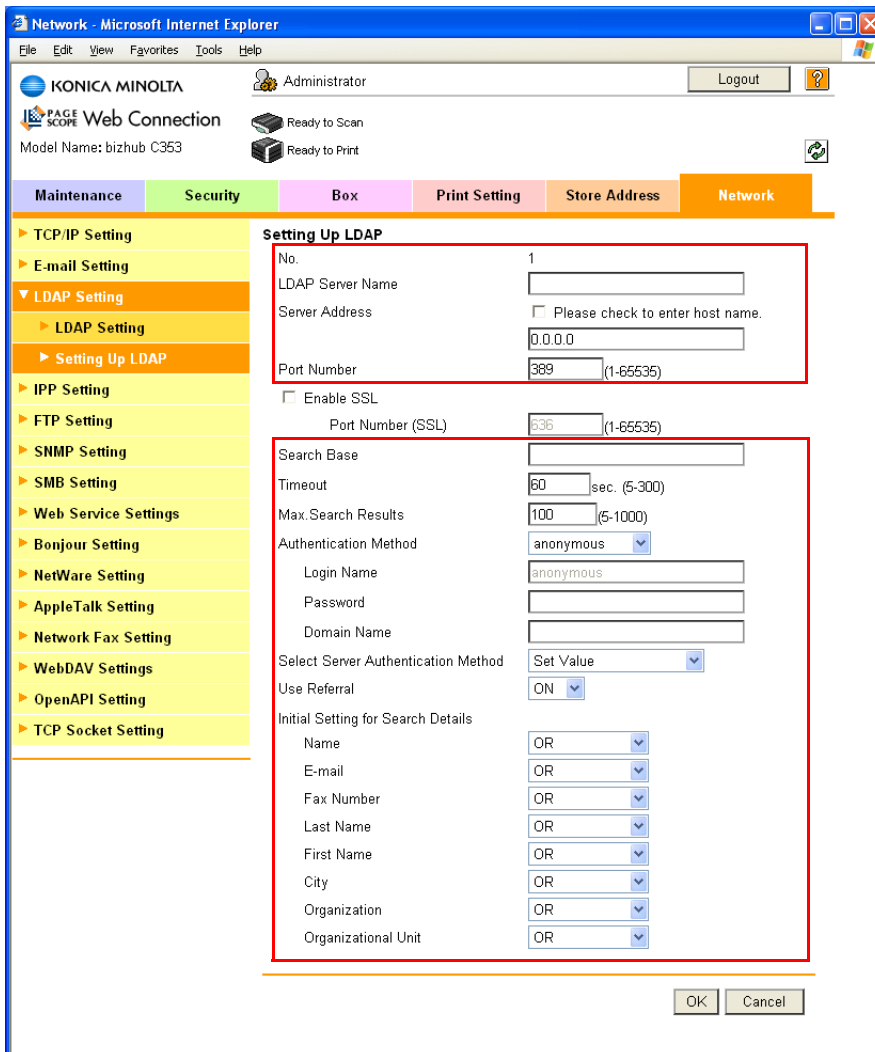

Item	Definition	Prior confirmation
LDAP Server Name	Specify the name of the LDAP server.	
Server Address	Specify the LDAP server address. (Format: "****.***.***.***", Range for ***: 0 to 255) If the DNS server is specified, the address can be specified using the host name. This item can also be specified with IPv6.	Address of the server
Port Number	Default setting: 389 Specify the port number.	Port number for the server
Search Base	Specify the search starting point in a hierarchical structure placed on the LDAP server. Searches are performed through the directory at the starting point and subdirectories under the directory.	Search base
Timeout	Specify the maximum wait time for a search operation.	
Max. Search Results	Specify the maximum number of destinations to be displayed after a search.	

Item	Definition	Prior confirmation
Authentication Method	Select the authentication method used for logging in to the LDAP server. If "anonymous" is selected, it is not necessary to specify the login name, password, and domain name. When "GSS-SPNEGO" is selected, the machine logs in to the server using the Kerberos authentication method. The Kerberos authentication method is supported by Active Directory.	Authentication method for the server
Login Name	Specify the login name for logging in to the LDAP server (up to 255 characters).	
Password	Specify the password for logging in to the LDAP server (up to 128 characters).	
Domain Name	Specify the domain name for logging in to the LDAP server (up to 64 characters). If "GSS-SPNEGO" is selected, specify the domain name of Active Directory.	Authentication method Domain name
Select Server Authentication Method	Specify the server authentication method. If "Set Value" is selected, the specified login name, password, and domain name are used. If "Use User Authentication" is selected, the user name and password used for external server authentication are used. When "Dynamic Authentication" is selected, a user name and password is requested for address search (LDAP).	
Use Referral	To use the referral function, select "ON".	
Initial Setting for Search Details	Specify the conditions for performing a detailed LDAP search.	



#### Detail

Select the authentication method that is used by the LDAP server being used. For details, refer to the manual for the LDAP server being used.

## 1.12.5 LDAP over SSL

### Setting Up LDAP

In Administrator mode of PageScope Web Connection, select the Network tab - "LDAP Setting" - "Setting Up LDAP" - [Edit].

Specify the following settings.

Item	Definition	Prior confirmation
Enable SSL	To encrypt communication between this machine and the LDAP server using SSL, select the "Enable SSL" check box.	Whether the sever supports SSL
Port Number (SSL)	Default setting: 636 Specify the port number used in SSL communication.	Port number for the server

### Action for Invalid Certificate

In Administrator mode of PageScope Web Connection, select the Security tab - "SSL/TLS Setting" - "Action for Invalid Certificate".

Specify the following setting.

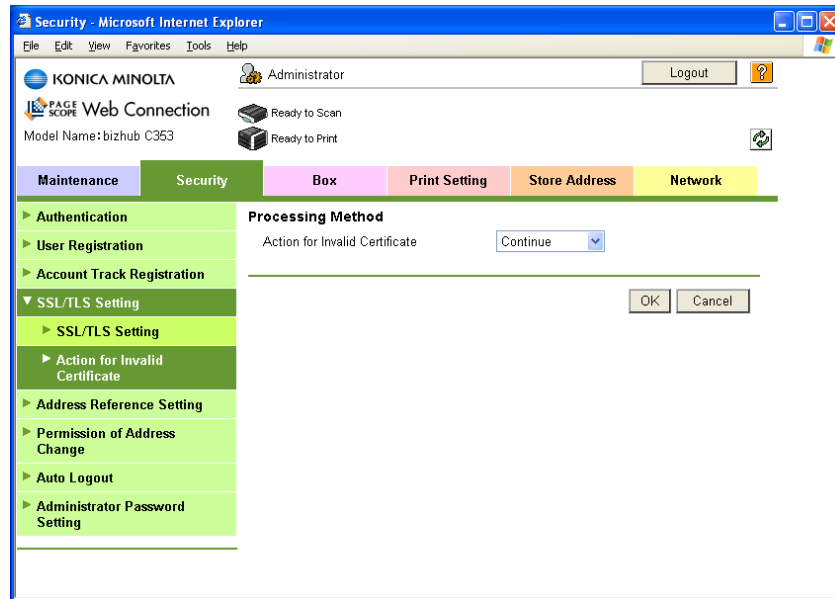

Item	Definition	Prior confirmation
Action for Invalid Certificate	Specify the operation when the validity period for the received certificate has expired. If "Continue" is selected, processing continues even if the date of the certificate is invalid. If "Delete the Job" is selected, the job is deleted if the date of the certificate is invalid.	

### 1.12.6 DNS Server Settings

To specify Active Directory as the LDAP server and select "GSS-SPNEGO" as the authentication method, specify a DNS server synchronized with Active Directory in the DNS Server Settings of this machine.

For details on the DNS server, refer to ["Specifying general settings for TCP/IP-based communication" on page 1-2.](#)

### 1.12.7 Date/Time Setting

When using Active Directory, specify the date and time on this machine.

For details, refer to ["Specifying the date and time on this machine" on page 1-16.](#)



## 1.13 Sending scan data by FTP

Specify settings for sending scan data to the FTP server.

In a network environment with an FTP server, scan data can be sent to a specified folder in the FTP server on the network. The data sent to the FTP server can be downloaded from a computer on the network. This function is suitable for transmitting large-sized data, such as high-resolution data.

If a proxy server is available in the network environment, an FTP server on the Internet can be accessed through the proxy server.

Specify the settings according to the following flowchart.

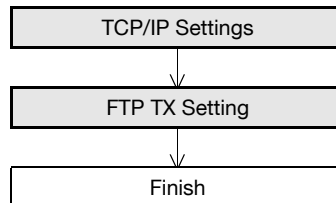

### Note

For details on registering FTP, refer to ["Registering or editing an address book destination" on page 1-155](#).

For details on the FTP-based file transmission, refer to the User's Guide [Network Scan/Fax/Network Fax Operations].

### 1.13.1 TCP/IP Settings

Specify settings to use this machine in a TCP/IP network environment.

For details, refer to ["Specifying general settings for TCP/IP-based communication" on page 1-2](#).

### 1.13.2 FTP TX Setting

In Administrator mode of PageScope Web Connection, select the Network tab - "FTP Setting" - "FTP TX Settings".

Specify the following settings.

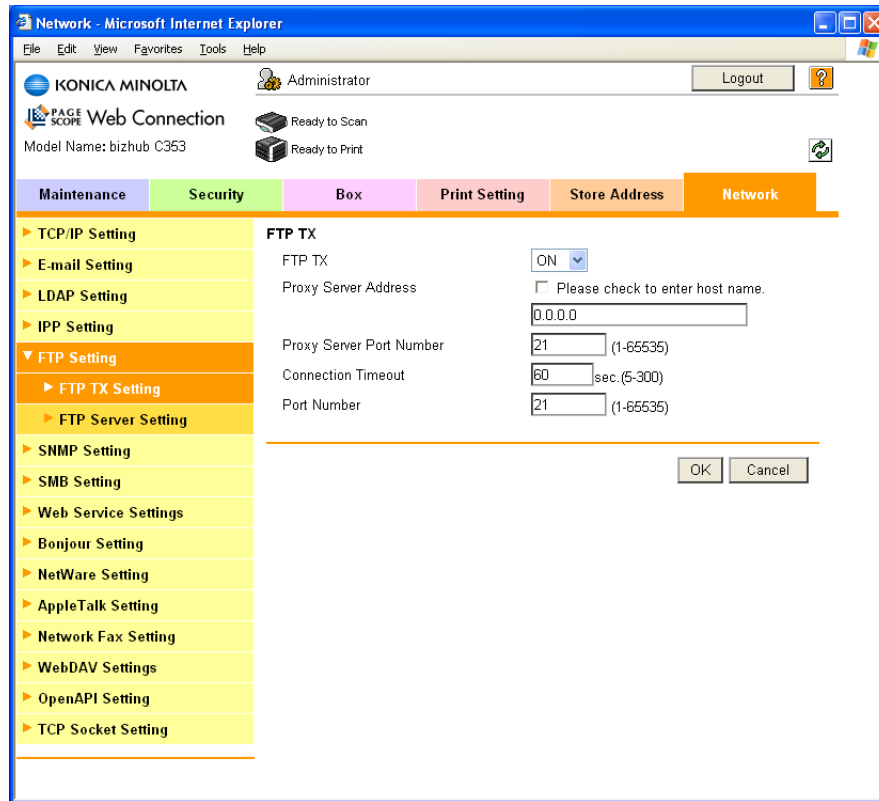

Item	Definition	Prior confirmation
FTP TX	Select "ON".	
Proxy Server Address	To send data via a proxy server, specify the proxy server address. (Format: "****.***.***.***", Range for ***: 0 to 255) If the DNS server is specified, the address can be specified using the host name. This item can also be specified with IPv6.	Address of the server
Proxy Server Port Number	Specify the port number.	Port number for the server
Connection Timeout	Specify the time period before the server connection times out.	
Port Number	Default setting: 21 Specify the port number.	Port number for the server

## 1.14 Sending scan data by WebDAV

Specify settings for sending scan data to the WebDAV server.

In a network environment with a WebDAV server, scan data can be sent to a specified folder in the WebDAV server on the network. The data sent to the WebDAV server can be downloaded from a computer on the network.

WebDAV is based on extended specifications of HTTP, and therefore the security technology of HTTP can be used. These settings ensure safer file transmission by encrypting communication with the WebDAV server using SSL.

If a proxy server is available in the network environment, an WebDAV server on the Internet can be accessed through the proxy server.

Specify the settings according to the following flowchart.

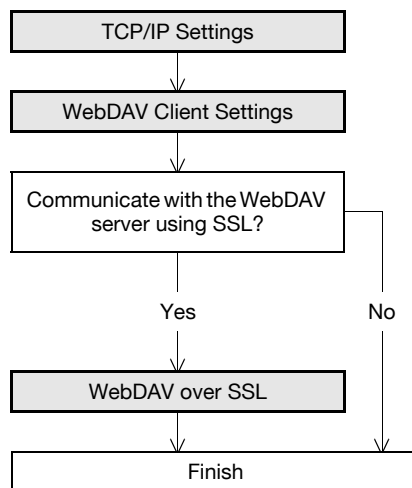

### Note

For details on registering WebDAV addresses, refer to "[Registering or editing an address book destination](#)" on page 1-155.

For details on the WebDAV-based file transmission, refer to the User's Guide [Network Scan/Fax/Network Fax Operations].



### Detail

Whether or not to send using SSL encryption is specified at address registration. For details, refer to "[Store Address](#)" on page 1-155.

### 1.14.1 TCP/IP Settings

Specify settings to use this machine in a TCP/IP network environment.

For details, refer to "[Specifying general settings for TCP/IP-based communication](#)" on page 1-2.

## 1.14.2 WebDAV Client Settings

In Administrator mode of PageScope Web Connection, select the Network tab - "WebDAV Settings" - "WebDAV Client Settings".

Specify the following settings.

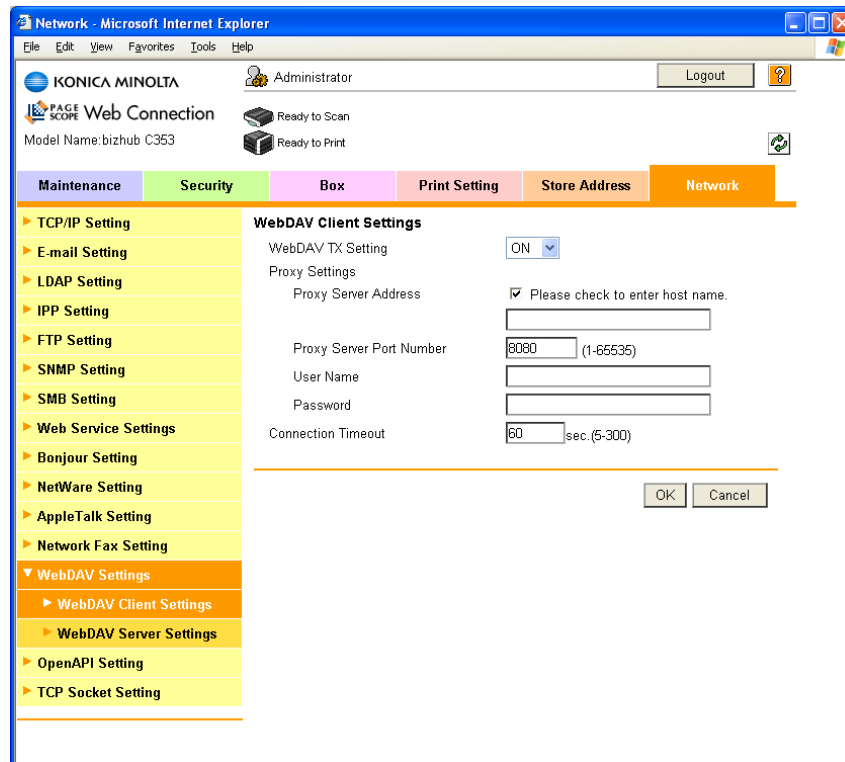

Item	Definition	Prior confirmation
WebDAV TX Setting	Select "ON".	
Proxy Server Address	To send data via a proxy server, specify the proxy server address. (Format: ".*.*.*.*", Range for *.*: 0 to 255) If the DNS server is specified, the address can be specified using the host name. This item can also be specified with IPv6.	Address of the server
Proxy Server Port Number	Specify the port number.	Port number for the server
User Name	Specify the user name for the proxy server (up to 63 characters).	
Password	Specify the password for the proxy server (up to 63 characters).	
Connection Timeout	Specify the time period before the server connection times out.	

### 1.14.3 WebDAV over SSL

In Administrator mode of PageScope Web Connection, select the Security tab - "SSL/TLS Setting" - "Action for Invalid Certificate".

Specify the following setting.

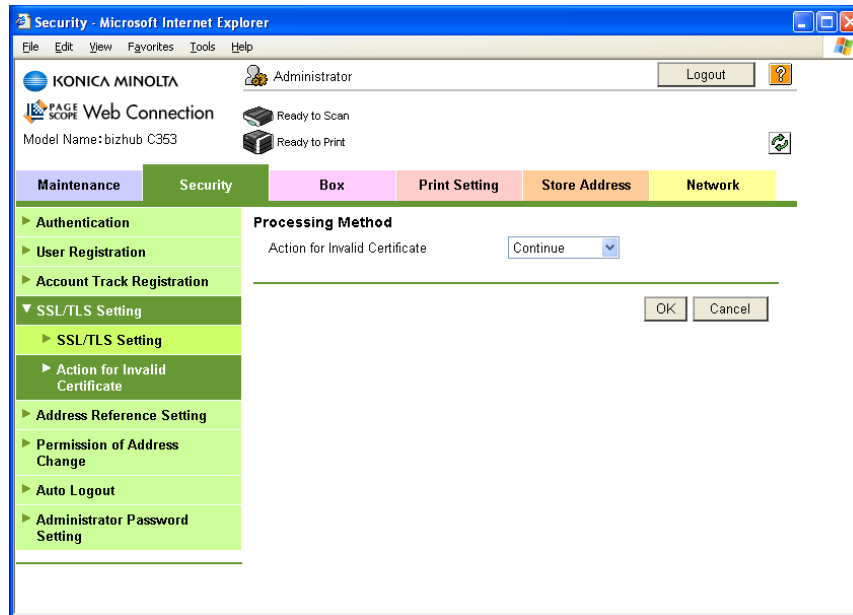

Item	Definition	Prior confirmation
Action for Invalid Certificate	Specify the operation when the validity period for the received certificate has expired. If "Continue" is selected, processing continues even if the date of the certificate is invalid. If "Delete the Job" is selected, the job is deleted if the date of the certificate is invalid.	

## 1.15 Sending an Internet fax

Specify settings for sending an Internet fax.

In order to use the Internet fax function, settings by a service engineer is required. For details, contact your service representative.

The Internet fax function sends and receives scanned originals as an attached file (TIFF format) via the intranet or Internet. This via-intranet or -Internet communication largely reduces the communication cost as compared with general fax messages.

Communication by combining POP before SMTP, APOP, SMTP authentication or encryption using SSL/TLS is available. For details, refer to ["Sending scan data by E-mail" on page 1-23](#).

Specify the settings according to the following flowchart.

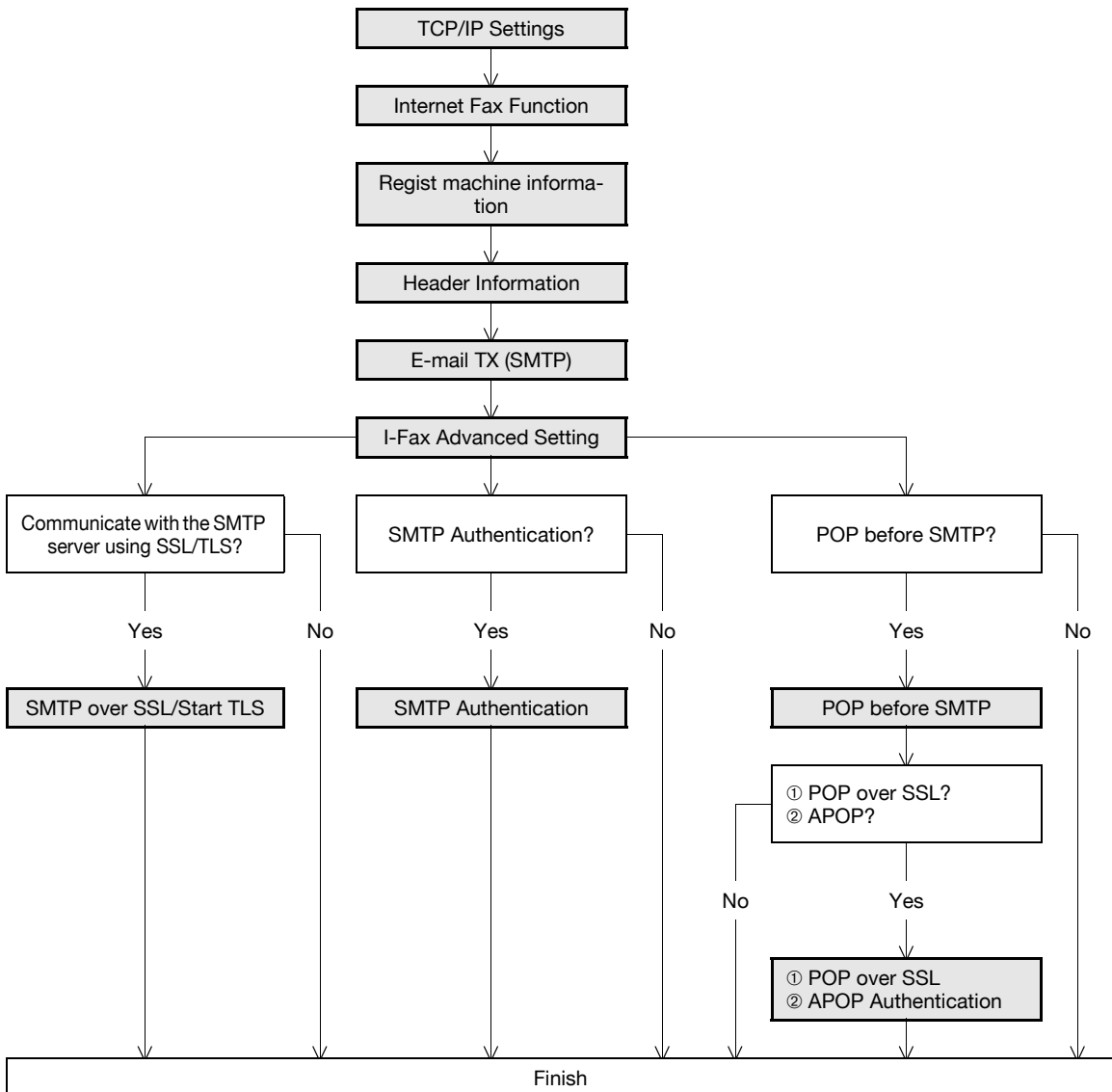

### Note

For details on registering I-Fax addresses, refer to ["Registering or editing an address book destination" on page 1-155](#).

For details on the Internet fax operation, refer to the User's Guide [Network Scan/Fax/Network Fax Operations].

### 1.15.1 TCP/IP Settings

Specify settings to use this machine in a TCP/IP network environment.

For details, refer to ["Specifying general settings for TCP/IP-based communication" on page 1-2](#).

## 1.15.2 Internet Fax Function

On the Administrator Settings screen of the control panel, select [Network Settings] - [2 Network Fax Setting] - [1 Network Fax Function Setting].

Specify the following setting.



### Note

For details on displaying the Network Setting screen, refer to "[Displaying the Network Settings screen](#)" on page 2-2.

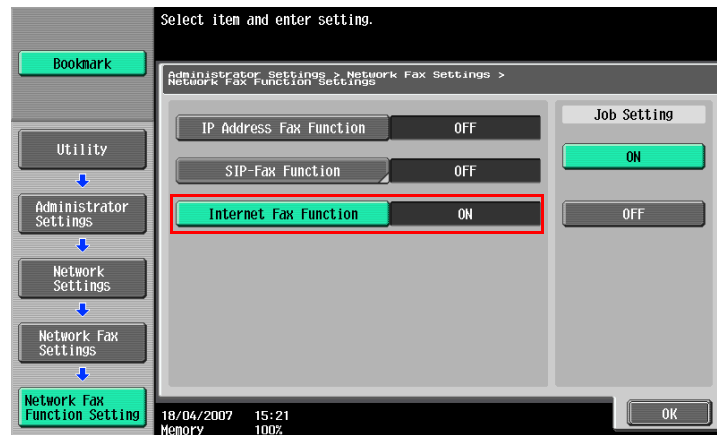

Item	Definition	Prior confirmation
Internet Fax Function	Select [ON].	

### 1.15.3 Regist machine information

#### Device Mail Address

In Administrator mode of PageScope Web Connection, select the Network tab - "E-mail Setting" - "E-mail TX (SMTP)".

Specify the following setting.

The screenshot shows the 'E-mail TX (SMTP)' configuration page in the PageScope Web Connection interface. The 'Device Mail Address' field is highlighted with a red box. The page includes various settings such as 'E-mail TX Setting', 'Scan to E-mail', 'E-mail Notification', 'Total Counter Notification', 'SMTP Server Address', 'Use SSL/TLS', 'Port Number', 'Port No.(SSL)', 'Connection Timeout', 'Max Mail Size', 'Server Capacity', 'Admin. E-mail Address', 'Authentication Setting', 'POP before SMTP', 'POP before SMTP Time', 'SMTP Authentication', 'User ID', 'Password', 'Domain Name', and 'Binary Division'.

Item	Definition	Prior confirmation
Device Mail Address	Specify the address for the device (up to 320 characters). If no address is specified here, the Internet fax cannot be sent.	Address for the device



## Machine Setting

In Administrator mode of PageScope Web Connection, select the Maintenance tab - "Machine Setting".  
Specify the following setting.

The screenshot shows the 'Maintenance - Microsoft Internet Explorer' window. The browser title bar indicates the user is logged in as 'Administrator'. The page header includes the Konica Minolta logo and 'Web Connection' status (Ready to Scan, Ready to Print). The 'Maintenance' tab is selected, and the 'Machine Setting' sub-tab is active. The 'Machine Setting' section contains the following fields:

- Device Name (highlighted with a red box)
- Device Location
- Administrator Name
- Admin. E-mail Address

Buttons for 'OK' and 'Cancel' are located at the bottom right of the form.

Item	Definition	Prior confirmation
Device Name	Specify the device name (up to 255 characters). This name is contained in the subject of the Internet fax.	

### 1.15.4 Header Information

In Administrator mode of PageScope Web Connection, select the Store Address tab - "Header Information". Specify the following settings.

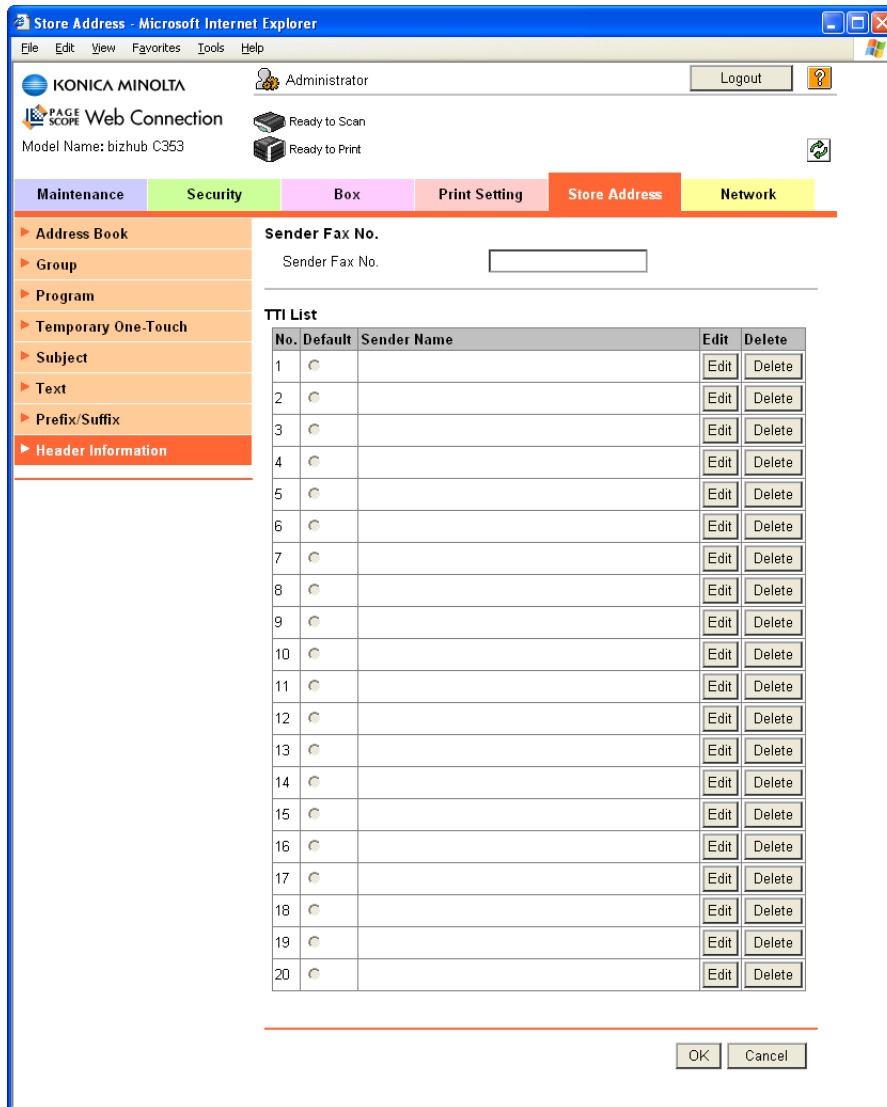

Item	Definition	Prior confirmation
Sender Fax No.	Register the sender fax number. Normally enter the fax number of this machine.	
Default	If no sender name is specified when sending a fax, the sender name with a check mark is used.	
Sender Name	Displays registered sender names.	
[Edit]	Registers or edits the sender name.	
[Delete]	Deletes the registered sender name.	

#### Registration

Item	Definition	Prior confirmation
No.	Displays the registration number.	
Sender Name	Enter the sender name (up to 30 characters).	

### 1.15.5 E-mail TX (SMTP)

Specify settings for sending messages.

For details, refer to "E-mail TX (SMTP)" on page 1-24.

### 1.15.6 I-Fax Advanced Setting

In Administrator mode of PageScope Web Connection, select the Network tab - "E-mail Setting" - "I-FAX Advanced Setting".

Specify the following settings.



#### Detail

*If the Internet fax function is disabled, this menu item is not displayed.*

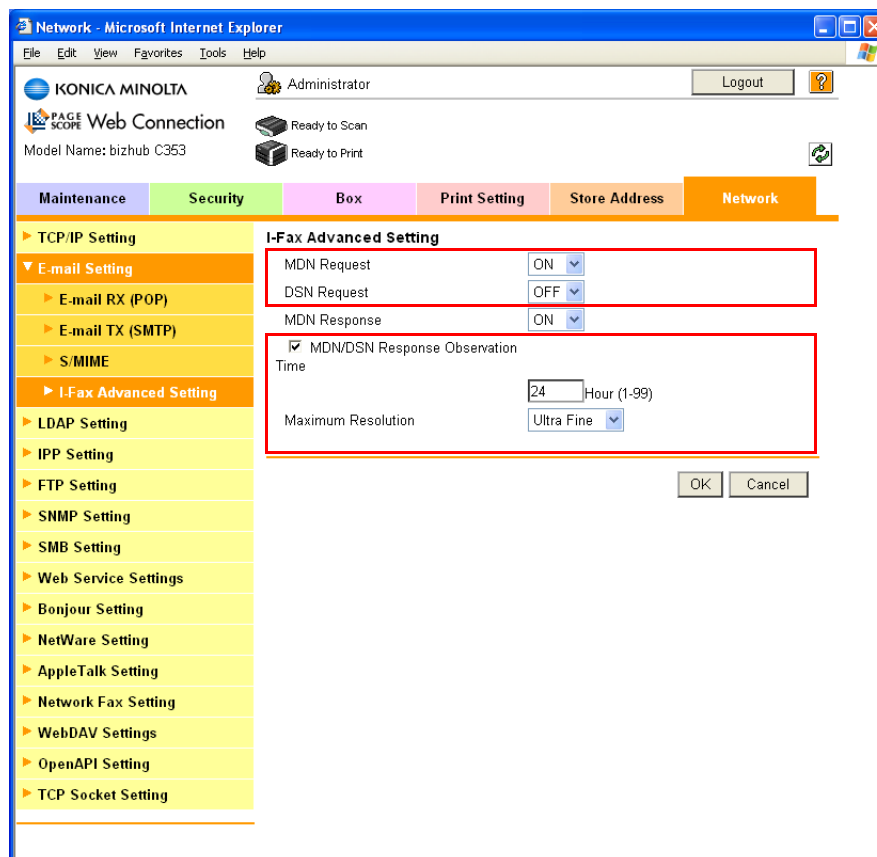

Item	Definition	Prior confirmation
MDN Request	Select "ON". If the fax is printed at the receiving side, MDN response can be received.	
DSN Request	Select "ON". If the fax reaches the mail server at the receiving side, DSN response can be received. If MDN is specified to "ON", DSN is not required.	
MDN/DSN Response Observation Time	Specify the waiting time for MDN or DSN response. MDN or DSN response of which set waiting time was up is ignored.	
Maximum Resolution	Specify the maximum resolution.	

### 1.15.7 SMTP over SSL/Start TLS

Specify the settings for SMTP over SSL/Start TLS.

For details, refer to "SMTP over SSL/Start TLS" on page 1-26.

### **1.15.8 SMTP Authentication**

Specify the settings for SMTP authentication.

For details, refer to ["SMTP Authentication" on page 1-27](#).

### **1.15.9 POP before SMTP**

Specify the settings for POP before SMTP.

For details, refer to ["POP before SMTP" on page 1-27](#).

### **1.15.10 POP over SSL**

Specify the settings for POP over SSL.

For details, refer to ["POP over SSL" on page 1-29](#).

### **1.15.11 APOP Authentication**

Specify the settings for APOP authentication.

For details, refer to ["APOP Authentication" on page 1-30](#).

## 1.16 Receiving Internet faxes

Specify settings for receiving Internet faxes.

In order to use the Internet fax function, setting by a service engineer is required. For details, contact your service representative.

The Internet fax function sends and receives scanned originals as an attached file (TIFF format) via the intranet (internal company networks) or Internet. This via-intranet or -Internet communication largely reduces the communication cost as compared with general fax messages.

Performing APOP authentication when receiving an Internet fax ensures safer communication.

Specify the settings according to the following flowchart.

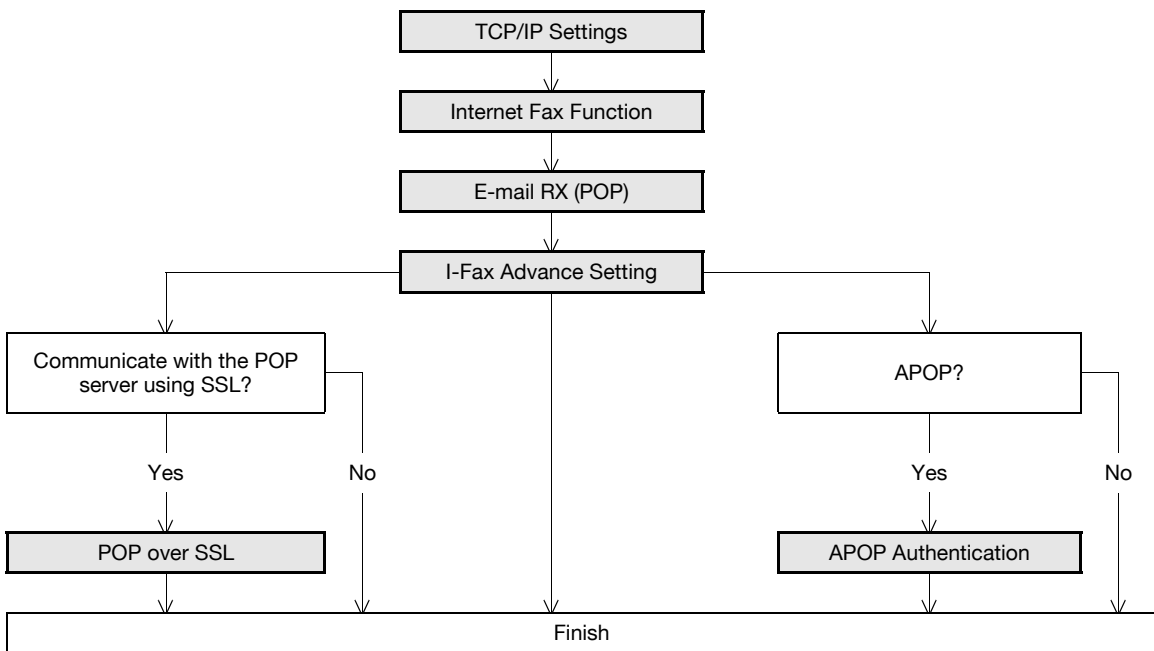

### Note

For details on registering I-Fax addresses, refer to ["Registering or editing an address book destination" on page 1-155](#).

For details on the Internet fax operation, refer to the User's Guide [Network Scan/Fax/Network Fax Operations].

### 1.16.1 TCP/IP Settings

Specify settings to use this machine in a TCP/IP network environment.

For details, refer to ["Specifying general settings for TCP/IP-based communication" on page 1-2](#).

### 1.16.2 Internet Fax Function

Enable the Internet fax function of this machine.

For details, refer to ["Internet Fax Function" on page 1-46](#).

### 1.16.3 E-mail RX (POP)

In Administrator mode of PageScope Web Connection, select the Network tab - "E-mail Setting" - "E-mail RX (POP)".

Specify the following settings.

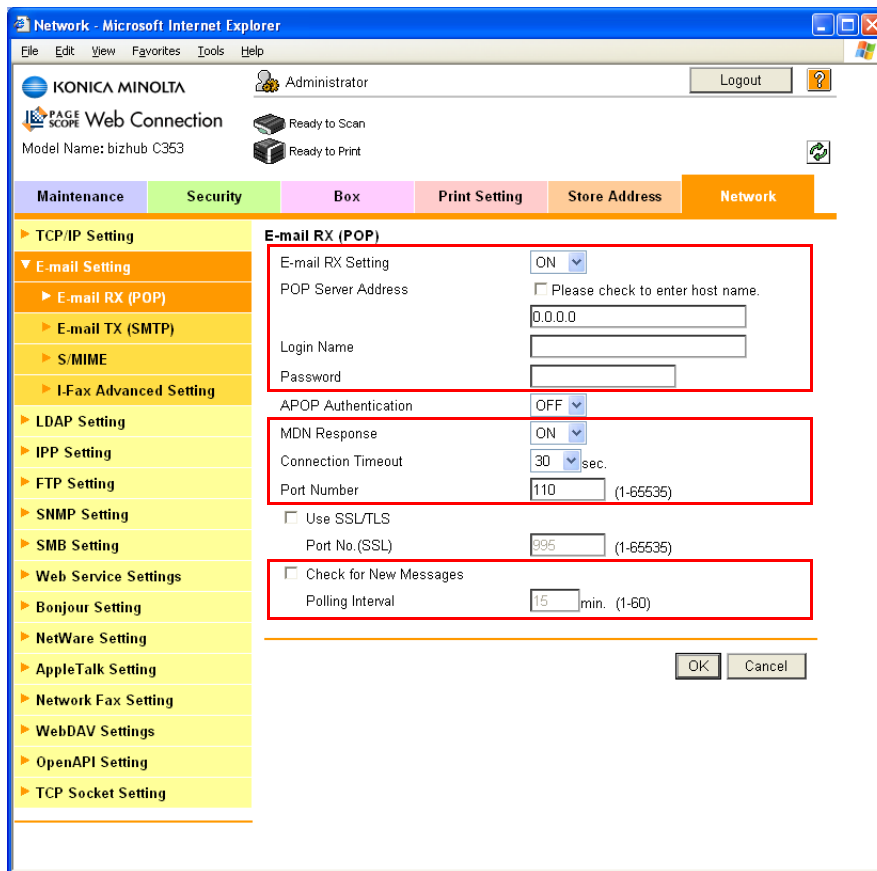

Item	Definition	Prior confirmation
E-mail RX Setting	Select "ON".	
POP Server Address	Specify the POP server address. (Format: "****.***.***.***", Range for ***: 0 to 255) If the DNS server is specified, the address can be specified using the host name. This item can also be specified with IPv6.	Address of the server
Login Name	Enter the login name for the POP server (up to 63 characters).	
Password	Type in the login password for the POP server (up to 15 characters).	
Connection Timeout	Specify the time period before the server connection times out.	
Port Number	Default setting: 110 Specify the port number.	Port number for the server
Check for New Messages	To automatically receive messages, select the "Check for New Messages" check box.	
Polling Interval	To automatically receive messages, specify an interval for receive messages automatically.	



**Detail**

By touching [Receive I-Fax] on the Fax/Scan mode screen of the control panel, E-mail messages can be manually received.

### 1.16.4 I-Fax Advance Setting

In Administrator mode of PageScope Web Connection, select the Network tab - "E-mail Setting" - "I-FAX Advanced Setting".

Specify the following setting.



#### Detail

*If the Internet fax function is disabled, this menu item is not displayed.*

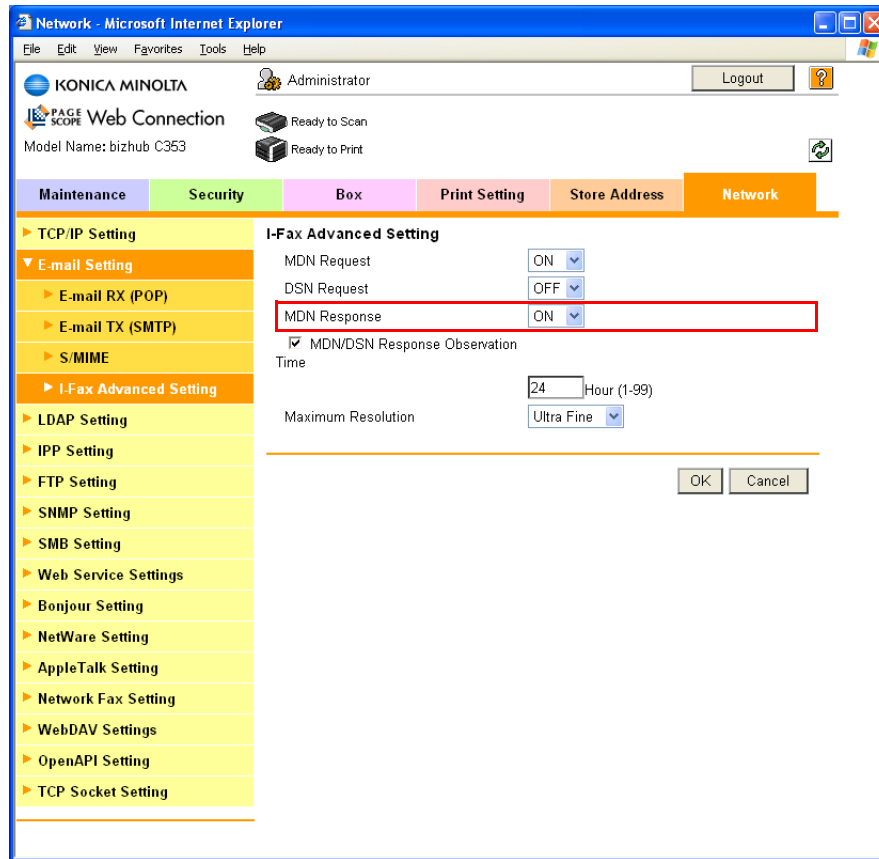

Item	Definition	Prior confirmation
MDN Response	To reply to the message disposition notification request from the sender, select "ON".	

### 1.16.5 POP over SSL

Specify the settings for POP over SSL.

For details, refer to ["POP over SSL" on page 1-29](#).

### 1.16.6 APOP Authentication

Specify the settings for APOP authentication.

For details, refer to ["APOP Authentication" on page 1-30](#).

## 1.17 Sending and receiving IP address faxes

Specify settings for sending and receiving IP address faxes.

To use the IP address fax function, this machine must be equipped with an optional fax kit. In order to use the IP address fax function, setting by a service engineer is required. For details, contact your service representative.

The IP address fax enables communication on the IP network. Specify the host name or IP address for the destination to send a Fax. SMTP protocol is used for sending and receiving faxes. Because IP address faxes are sent and received via the SMTP server function of this machine, no SMTP server is required.

Specify the settings according to the following flowchart.

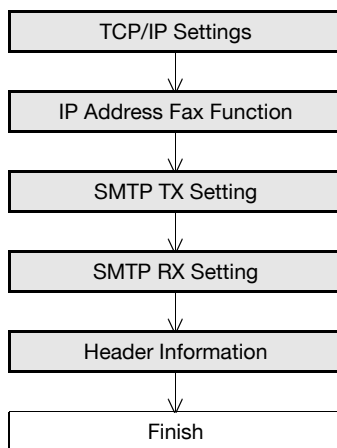

### Note

For details on registering IP address fax addresses, refer to "[Registering or editing an address book destination](#)" on page 1-155.

For details on the IP address fax operation, refer to the User's Guide [Network Scan/Fax/Network Fax Operations].

### 1.17.1 TCP/IP Settings

Specify settings to use this machine in a TCP/IP network environment.

For details, refer to "[Specifying general settings for TCP/IP-based communication](#)" on page 1-2.

### 1.17.2 IP Address Fax Function

On the Administrator Settings screen of the control panel, select [Network Settings] - [2 Network Fax Setting] - [1 Network Fax Function Setting].

Specify the following setting.



### Note

For details on displaying the Network Setting screen, refer to "[Displaying the Network Settings screen](#)" on page 2-2.



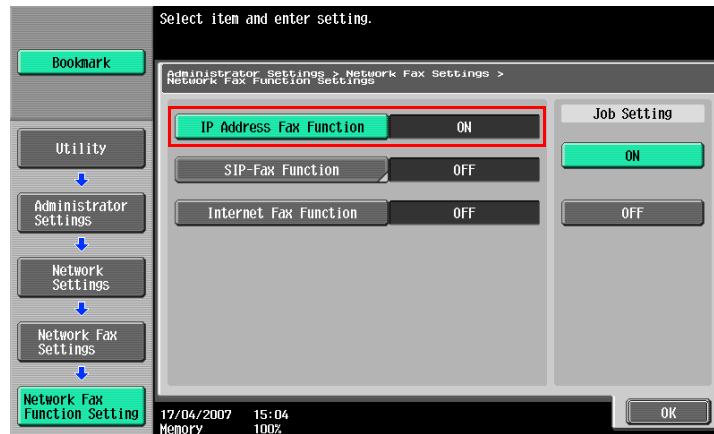

Item	Definition	Prior confirmation
IP Address Fax Function	Select [ON].	

### 1.17.3 SMTP TX Setting

In Administrator mode of PageScope Web Connection, select the Network tab - "Network Fax Setting" - "SMTP TX Setting".

Specify the following settings.

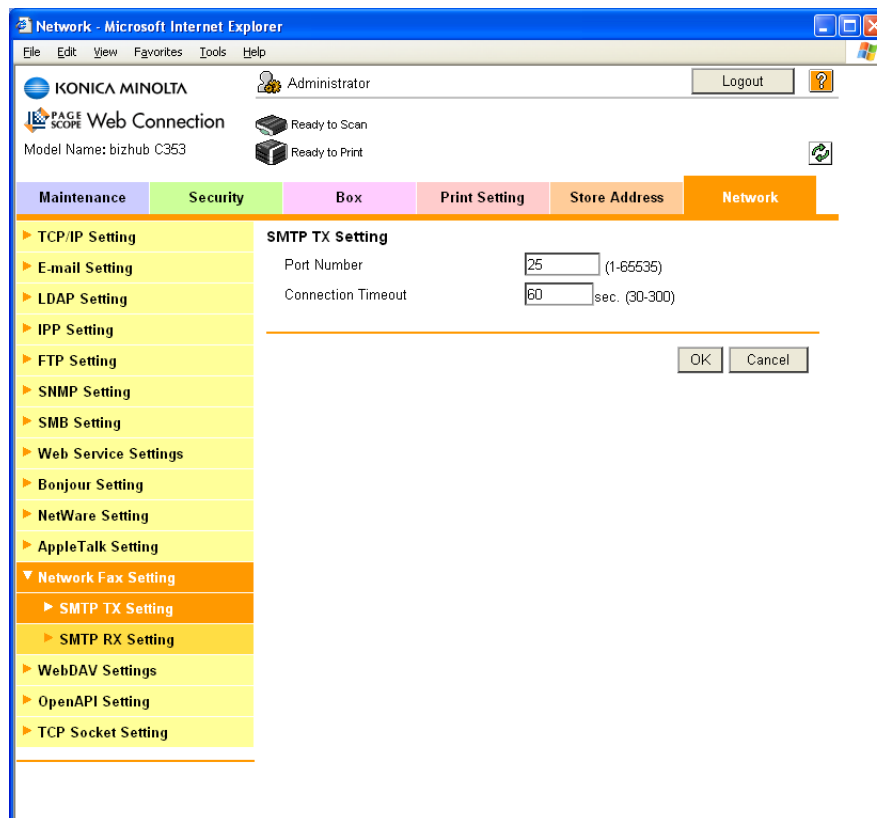

Item	Definition	Prior confirmation
Port Number	Default setting: 25 Specify the port number.	Port number to be used
Connection Timeout	Specify the time period before the server connection times out.	

## 1.17.4 SMTP RX Setting

In Administrator mode of PageScope Web Connection, select the Network tab - "Network Fax Setting" - "SMTP RX Setting".

Specify the following settings.

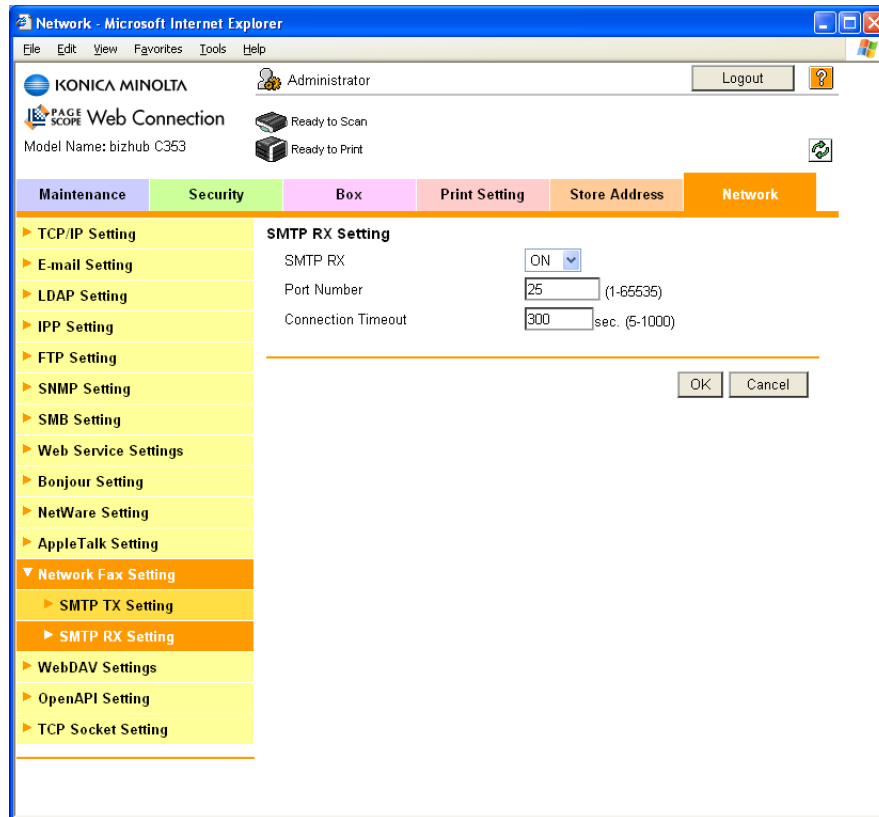

Item	Definition	Prior confirmation
SMTP RX	Select "ON".	
Port Number	Default setting: 25 Specify the port number.	Port number to be used
Connection Timeout	Specify the time period before the server connection times out.	

## 1.17.5 Header Information

Register sender information for fax transmissions.

For details, refer to "[Header Information](#)" on page 1-49.

## 1.18 Importing images using the TWAIN scan

Specify settings for using this machine as a scanner.

Using the TWAIN driver enables this machine to be used as a scanner. This machine can be controlled from a computer connected to the network, and the scanned data can be imported into an application on the computer to be processed.

Specify the settings according to the following flowchart.

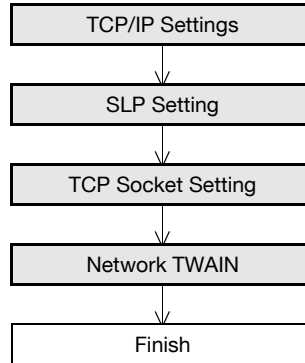

### Note

*For details on installing the TWAIN driver, refer to the TWAIN driver manual on the Driver CD-ROM.*

### 1.18.1 TCP/IP Settings

Specify settings to use this machine in a TCP/IP network environment.

For details, refer to "[Specifying general settings for TCP/IP-based communication](#)" on page 1-2.

### 1.18.2 SLP Setting

In Administrator mode of PageScope Web Connection, select the Network tab - "TCP/IP Setting" - "TCP/IP Setting".

Specify the following setting.

Item	Definition	Prior confirmation
SLP	To search for this machine using TWAIN, select "Enable".	

### 1.18.3 TCP Socket Setting

In Administrator mode of PageScope Web Connection, select the Network tab - "TCP Socket Setting".  
Specify the following settings.

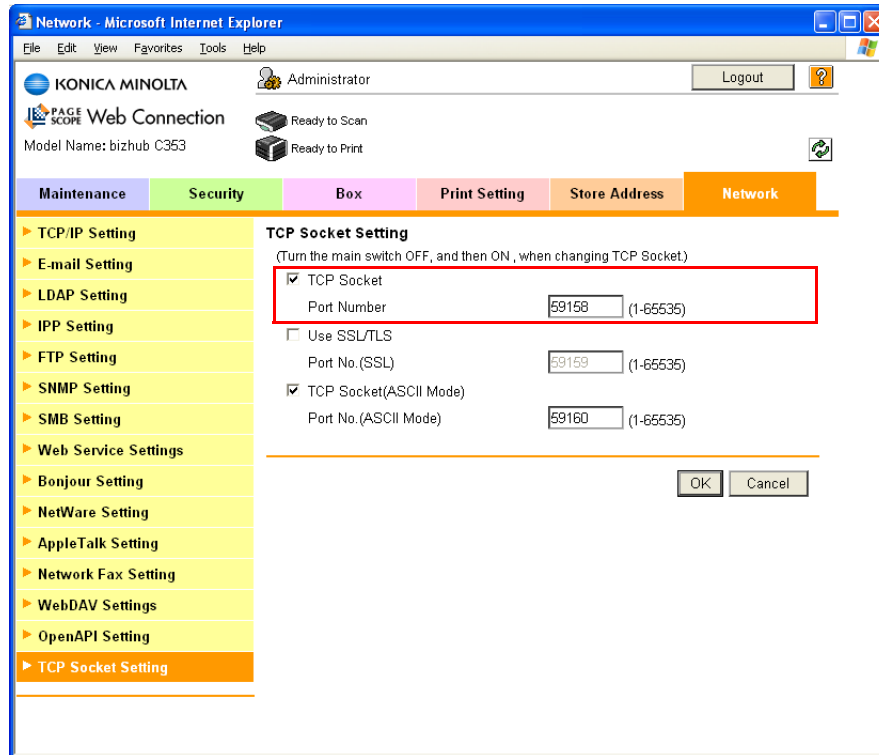

Item	Definition	Prior confirmation
TCP Socket	Select the "TCP Socket" check box.	
Port Number	Specify the port number.	

### 1.18.4 Network TWAIN

In Administrator mode of PageScope Web Connection, select the Maintenance tab - "Network TWAIN".  
Specify the following setting.

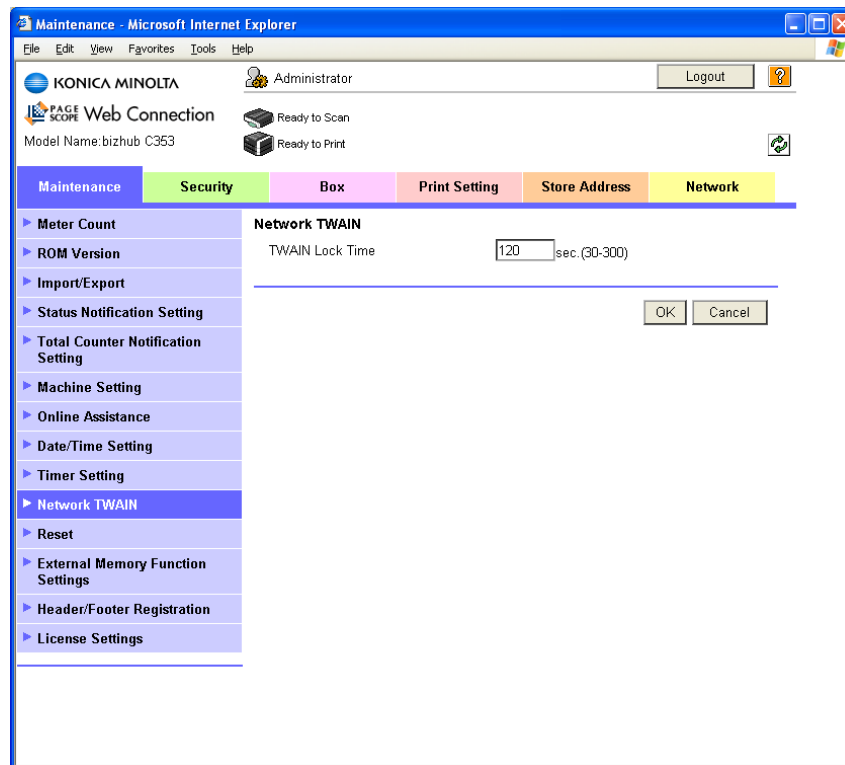

Item	Definition	Prior confirmation
TWAIN Lock Time	Specify the control panel lock time during TWAIN scan.	

## 1.19 Printing (LPR/Port9100)

Specify settings for printing by using LPR or Port9100.

LPR printing is performed via the network using the LPR protocol. LPR printing is used in the UNIX-like OS.

Port9100 printing is performed via the network by directly specifying the RAW port (Port9100) of this machine connected to the TCP/IP network as a printer of the print destination.

Specify the settings according to the following flowchart.

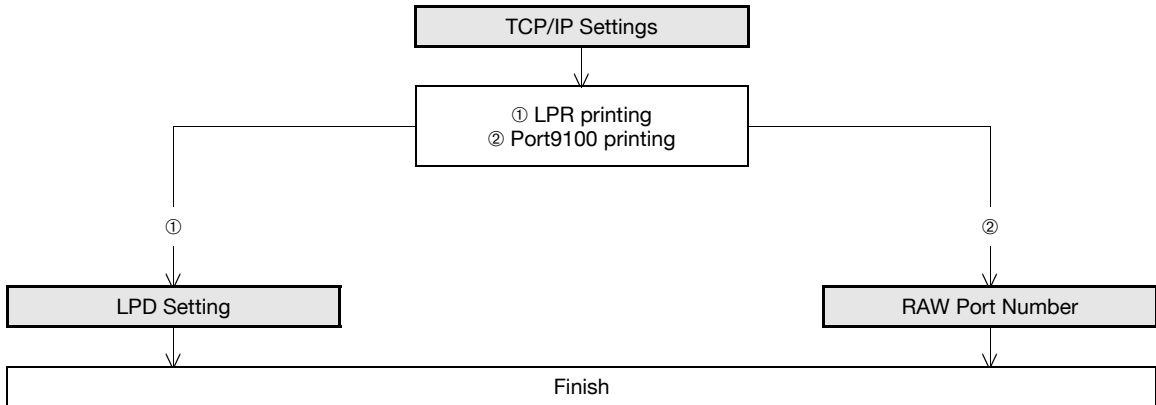

### Detail

To print data using LPR or Port9100, settings for the printer driver must be specified after these settings. For details, refer to the User's Guide [Print Operations].

### 1.19.1 TCP/IP Settings

Specify settings to use this machine in a TCP/IP network environment.

For details, refer to "[Specifying general settings for TCP/IP-based communication](#)" on page 1-2.

### 1.19.2 LPD Setting

In Administrator mode of PageScope Web Connection, select the Network tab - "TCP/IP Setting" - "TCP/IP Setting".

Specify the following setting.

Item	Definition	Prior confirmation
LPD	Select "Enable".	

### 1.19.3 RAW Port Number

In Administrator mode of PageScope Web Connection, select the Network tab - "TCP/IP Setting" - "TCP/IP Setting".

Specify the following setting.

Item	Definition	Prior confirmation
RAW Port Number	Select the check box for the port to be used, and then specify the RAW port number.	

## 1.20 Printing (SMB)

Specify settings for printing by using SMB.

The printer is sharable on the Windows network by using the SMB protocol. SMB printing is performed by directly specifying this machine on the Windows network from the computer.

This machine supports the direct hosting service. To execute SMB print in the IPv6 environment, the Direct Hosting setting must be enabled.

Specify the settings according to the following flowchart.

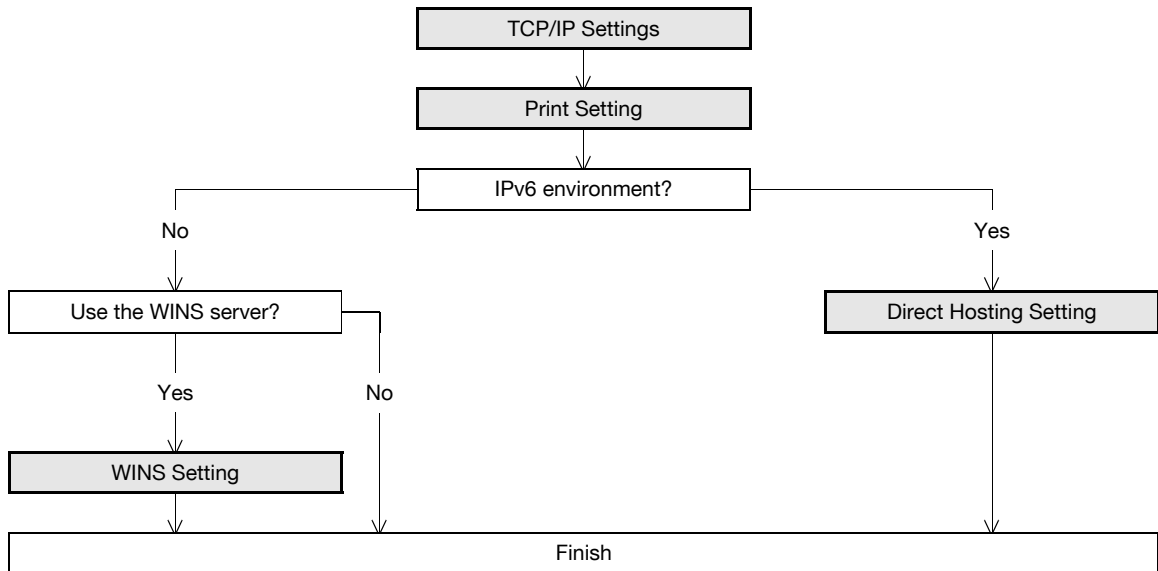

### Note

*For details on installing the printer driver, refer to the User's Guide [Print Operations].*

### 1.20.1 TCP/IP Settings

Specify settings to use this machine in a TCP/IP network environment.

For details, refer to "[Specifying general settings for TCP/IP-based communication](#)" on page 1-2.

## 1.20.2 Print Setting

In Administrator mode of PageScope Web Connection, select the Network tab - "SMB Setting" - "Print Setting".

Specify the following settings.

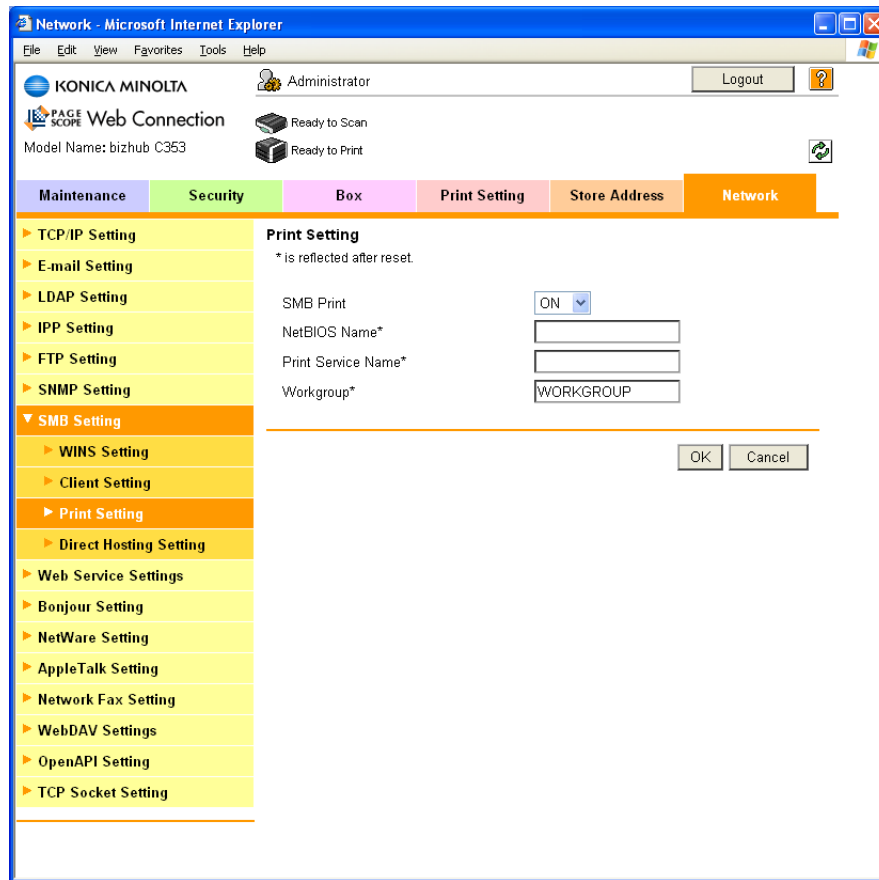

Item	Definition	Prior confirmation
SMB Print	Select "ON".	
NetBIOS Name	Specify the NetBIOS name with uppercase letters (up to 15 characters).	
Print Service Name	Specify the print service name with uppercase letters (up to 12 characters).	
Workgroup	Specify the workgroup name with uppercase letters (up to 15 characters).	Workgroup to which you belong

## 1.20.3 WINS Setting

To perform SMB print via the router, specify settings for the WINS server.

For details, refer to ["WINS Setting" on page 1-22](#).

## 1.20.4 Direct Hosting Setting

To execute SMB print in the IPv6 environment, enable the Direct Hosting setting.

For details, refer to ["Direct Hosting Setting" on page 1-21](#).



## 1.21 Printing (IPP)

Specify settings for printing using IPP.

IPP printing is performed via the network using the IPP protocol. Using the HTTP protocol can transfer print data to the printer on the network, and therefore also enabling output to a remote printer via the Internet.

Specify the settings according to the following flowchart.

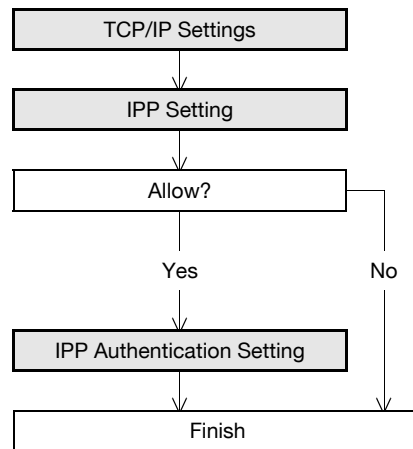

**Note**

*For details on installing the printer driver, refer to the User's Guide [Print Operations].*

### 1.21.1 TCP/IP Settings

Specify settings to use this machine in a TCP/IP network environment.

For details, refer to "[Specifying general settings for TCP/IP-based communication](#)" on page 1-2.

## 1.21.2 IPP Setting

In Administrator mode of PageScope Web Connection, select the Network tab - "IPP Setting".  
Specify the following settings.

The screenshot shows the 'IPP Setting' page in the PageScope Web Connection interface. The 'Network' tab is active, and the 'IPP Setting' section is highlighted. The settings are as follows:

- IPP Setting: ON
- Accept IPP job: ON
- Printer Name: [Text Input]
- Printer Location: [Text Input]
- Printer Information: [Text Input]
- Printer URI:
  - URI://TestData00
  - URI://TestData01
  - URI://TestData02
  - URI://TestData03
  - URI://TestData04
  - URI://TestData05
- Support Operation:
  - Print Job
  - Valid Job
  - Cancel Job
  - Open Job Attributes
  - Open Job
  - Open Printer Attributes
- IPP Authentication Setting:
  - IPP Authentication Setting
  - Authentication Method: requesting-user-name
  - User Name: user
  - Password: [Text Input]
  - realm: [Text Input]

Item	Definition	Prior confirmation
IPP Setting	Select "ON".	
Accept IPP job	Select "ON".	
Printer Name	Specify the printer name (up to 127 characters).	
Printer Location	Specify the printer location (up to 127 characters).	
Printer Information	Specify the printer information (up to 127 characters).	
Printer URI	Displays the URI of the printer that can use IPP when printing.	
Support Operation	Specify the print operations supported by IPP.	

### 1.21.3 IPP Authentication Setting

In Administrator mode of PageScope Web Connection, select the Network tab - "IPP Setting".

Specify the following settings.

Item	Definition	Prior confirmation
IPP Authentication Setting	To perform IPP printing, select the "IPP Authentication Setting" check box.	
Authentication Method	Specify the authentication method.	
User Name	Specify the user name (up to 20 characters).	
Password	Enter the password (up to 20 characters).	
realm	Specify realm (up to 127 characters). If the authentication method is digest, realm must be specified.	Authentication method

## 1.22 Printing (IPPS)

Specify settings for printing using IPPS.

When performing IPP printing with this machine, communication between the computer and this machine is encrypted using SSL. Encrypting communication using SSL improves security when printing using IPP.

Specify the settings according to the following flowchart.

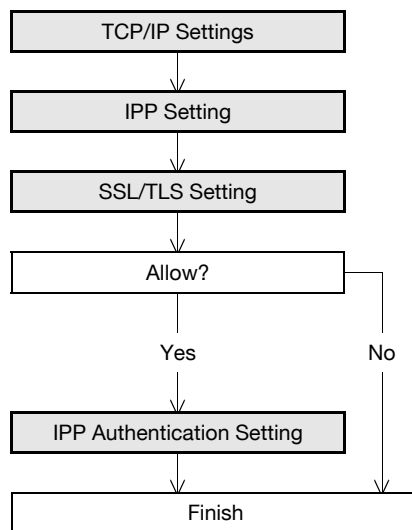

### Note

For details on installing the printer driver, refer to the User's Guide [Print Operations].



### Detail

When specifying to use IPPS printing in Windows Vista, enter "https://[Host Name].[Domain Name]/ipp". For [Host Name] and [Domain Name], use the names specified as the DNS host name and the DNS default domain name in the TCP/IP Settings. For details, refer to "[Specifying general settings for TCP/IP-based communication](#)" on page 1-2. Also, it is necessary that the computer must be able to resolve the names for this machine using DNS. Register this machine to the DNS server in advance, and specify settings for DNS at the computer side.

When the certificate of this machine is not published by certificate authority, register the certificate of this machine to Windows Vista as a certificate of "Trusted Root Certification Authorities" for "Local Computer" in advance.

### 1.22.1 TCP/IP Settings

Specify settings to use this machine in a TCP/IP network environment.

When specifying to use IPPS printing in Windows Vista, before creating a certificate, correctly specify the DNS Host Name and Default DNS Domain Name registered in the DNS server in the TCP/IP Settings. Otherwise, IPPS connection cannot be established.

For details, refer to "[Specifying general settings for TCP/IP-based communication](#)" on page 1-2.

### 1.22.2 IPP Setting

Specify settings for printing by using IPP.

For details, refer to "[IPP Setting](#)" on page 1-65.

### 1.22.3 SSL/TLS Setting

Encrypt communication with this machine using SSL.

For details, refer to "[Creating a certificate for this machine for SSL-based communication](#)" on page 1-7.

#### 1.22.4 IPP Authentication Setting

Specify settings when authentication is used when printing using IPP.

For details, refer to "[IPP Authentication Setting](#)" on page 1-66.

## 1.23 Printing (Bonjour)

Specify settings for printing by connecting this machine to a Macintosh computer using Bonjour. When connecting this machine to a Macintosh computer using Bonjour, the Bonjour settings must be specified.



### Note

For details on installing the printer driver, refer to the User's Guide [Print Operations].

### Bonjour Setting

In Administrator mode of PageScope Web Connection, select the Network tab - "Bonjour Setting".

Specify the following settings.

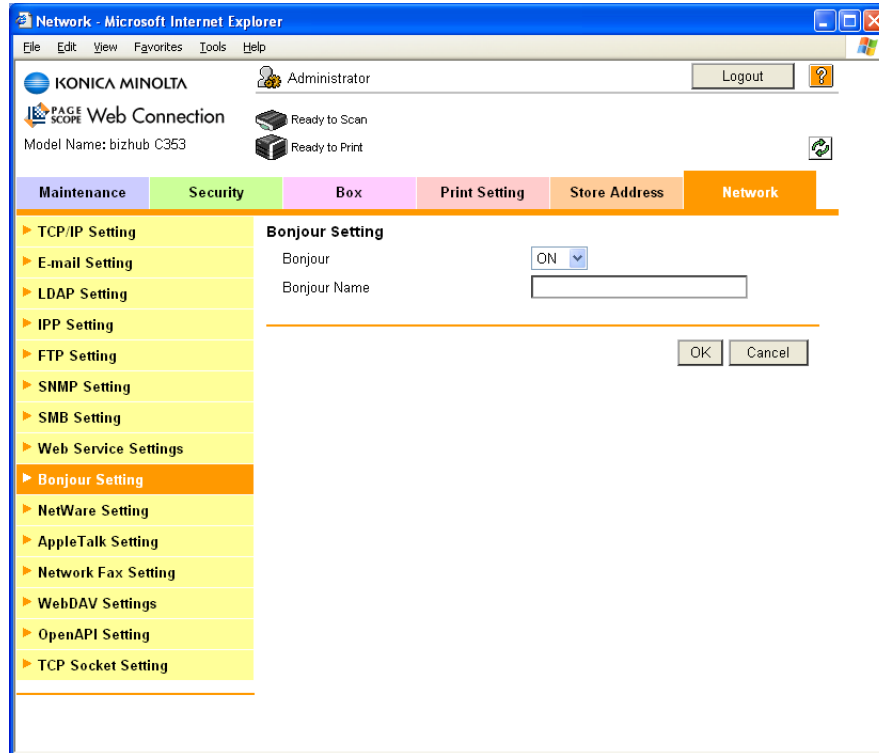

Item	Definition	Prior confirmation
Bonjour	Select "ON".	
Bonjour Name	Specify the Bonjour name that appears as the name of the connected device (up to 63 characters).	

## 1.24 Printing (AppleTalk)

Specify settings for printing by connecting this machine to a Macintosh computer using AppleTalk. When connecting this machine to a Macintosh computer using AppleTalk, the AppleTalk settings must be specified.



### Note

For details on installing the printer driver, refer to the User's Guide [Print Operations].

### AppleTalk Setting

In Administrator mode of PageScope Web Connection, select the Network tab - "AppleTalk Setting".

Specify the following settings.

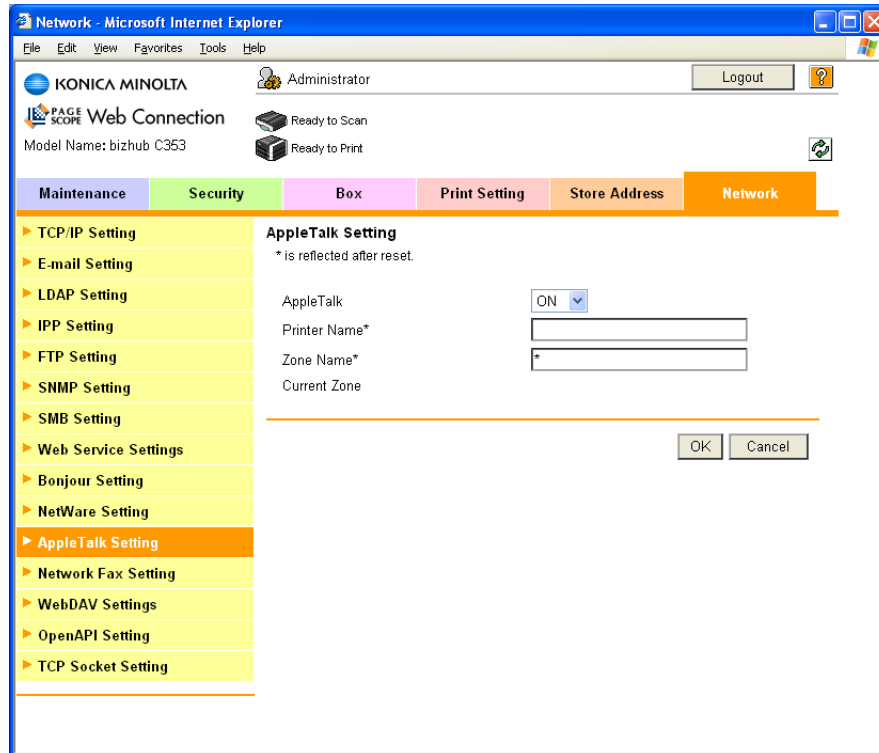

Item	Definition	Prior confirmation
AppleTalk	Select "ON".	
Printer Name*	Specify the printer name that appears on the selector (up to 31 characters).	
Zone Name*	Specify the zone name to which this machine belongs (up to 31 characters).	
Current Zone	Displays the current zone name.	

## 1.25 Printing (NetWare)

Specify settings for printing in a NetWare environment. Before printing in the NetWare environment, settings for using this machine in the NetWare environment must be specified.



### Note

For details on installing the printer driver, refer to the User's Guide [Print Operations].

### 1.25.1 NetWare Setting

In Administrator mode of PageScope Web Connection, select the Network tab - "NetWare Setting" - "NetWare Setting".

The screenshot shows the 'NetWare Setting' page in the PageScope Web Connection interface. The page is titled 'Network - Microsoft Internet Explorer' and shows the 'NetWare Setting' configuration page. The left sidebar contains a tree view with 'NetWare Setting' selected. The main content area shows various settings for NetWare, including IPX Setting (ON), Ethernet Frame Type (Auto Detect), NetWare Print Mode (OFF), PServer settings (Print Server Name, Password, Polling Interval, Bindery/NDS Setting), Bindery settings (File Server Name), NDS settings (NDS Context Name, NDS Tree Name), Nprinter/Rprinter settings (Print Server Name, Printer Number), and User Authentication Setting (ON).

Settings are different depending on the environment used. Specify the settings according to the following procedures.

#### For Remote Printer mode with NetWare 4.x bindery emulation

- ✓ Before using bindery emulation, check that bindery emulation is compatible with the NetWare server.
- 1 From a client computer, log in to NetWare with the Administrator permission as Bindery.
- 2 Start up Pconsole.
- 3 From the "Available Options" list, select "Quick Setup", and then press the [Enter] key.
- 4 Enter the appropriate names in the "Print Server Name", "Printer Name", and "Print Queue Name" fields, select "Other/Unknown" from the "Printer type" field, and then save the specified settings.
- 5 Press the [Esc] key to quit Pconsole.
- 6 Use the NetWare server console to load PSERVER.NLM.



Next, specify the following settings for "NetWare Setting".

Item	Definition	Prior confirmation
IPX Setting*	Select "ON".	
Ethernet Frame Type*	Specify the frame type to be used.	Frame type
NetWare Print Mode*	Select "NPrinter/Rprinter".	
Print Server Name*	Specify the printer server name to allow it to serve as Nprinter/Rprinter (up to 63 characters).	Print server name registered in step 4
Printer Number*	Enter the Nprinter/Rprinter printer number.	

#### For the print server mode with NetWare 4.x bindery emulation

- ✓ Before using bindery emulation, check that bindery emulation is compatible with the NetWare server.
  - ✓ To use the printer server mode, the IPX protocol must be loaded on the NetWare server.
- 1 From a client computer, log in to NetWare with the Administrator permission as Bindery.
  - 2 Start up Pconsole.
  - 3 From the "Available Options" list, select "Quick Setup", and then press the [Enter] key.
  - 4 Enter the appropriate names in the "Print Server Name", "Printer Name", and "Print Queue Name" fields, select "Other/Unknown" from the "Printer type" field, and then save the specified settings.
  - 5 Press the [Esc] key to quit Pconsole.

Next, specify the following settings for "NetWare Setting".

Item	Definition	Prior confirmation
IPX Setting*	Select "ON".	
Ethernet Frame Type*	Specify the frame type to be used.	Frame type
NetWare Print Mode*	Select "PServer".	
Print Server Name*	Specify the printer server name to allow it to serve as Pserver (up to 63 characters).	Print server name registered in step 4
Print Server Password*	If necessary, specify the password for the printer server (up to 63 characters).	
Polling Interval*	Specify an interval to make queries for jobs.	
Bindery/NDS Setting	Select "NDS/Bindery".	
File Server Name	Specify the priority file server name for Bindery mode (up to 47 characters).	

#### For NetWare 4.x Remote Printer mode (NDS)

- 1 Log in to NetWare as an administrator from a client computer.
- 2 Start up NWadmin.
- 3 Select either the organization or organizational unit container that offers the print service, and then click "Print Services Quick Setup" on the "Tools" menu.
- 4 Enter the appropriate names in the "Print Server Name", "Printer Name", "Print Queue Name", and "Print Queue Volume" fields, select "Other/Unknown" from the "Printer type" field, and then save the specified settings.
- 5 Use the NetWare server console to load PSERVER.NLM.

Next, specify the following settings for "NetWare Setting".

Item	Definition	Prior confirmation
IPX Setting*	Select "ON".	
Ethernet Frame Type*	Specify the frame type to be used.	Frame type
NetWare Print Mode*	Select "NPrinter/Rprinter".	
Print Server Name*	Specify the printer server name to allow it to serve as Nprinter/Rprinter (up to 63 characters).	Print server name registered in step 4
Printer Number*	Enter the Nprinter/Rprinter printer number.	

#### For NetWare 4.x/5.x/6 Print Server mode (NDS)

- ✓ To use the printer server mode, the IPX protocol must be loaded on the NetWare server.
- 1 Log in to NetWare as an administrator from a client computer.
- 2 Start up NWadmin.
- 3 Select either the organization or organizational unit container that offers the print service, and then click "Print Services Quick Setup (non-NDPS)" on the "Tools" menu.
- 4 Enter the appropriate names in the "Print Server Name", "Printer Name", "Print Queue Name", and "Print Queue Volume" fields, select "Other/Unknown" from the "Printer type" field, and then click [Create].

Next, specify the following settings for "NetWare Setting".

Item	Definition	Prior confirmation
IPX Setting*	Select "ON".	
Ethernet Frame Type*	Specify the frame type to be used.	Frame type
NetWare Print Mode*	Select "PServer".	
Print Server Name*	Specify the printer server name to allow it to serve as PServer (up to 63 characters).	Print server name registered in step 4
Print Server Password*	If necessary, specify the password for the printer server (up to 63 characters).	
Polling Interval*	Specify an interval to make queries for jobs.	
Bindery/NDS Setting	Select "NDS".	
NDS Context Name	Specify the NDS context name connected with the print server (up to 191 characters).	
NDS Tree Name	Specify the NDS tree name connected with the printer server (up to 63 characters).	

#### For NetWare 5.x/6 Novell Distributed Print Service (NDPS)

- ✓ Before specifying settings for NDPS, check that the NDPS broker and NDPS manager have been created and loaded.
- ✓ Also, check that the TCP/IP protocol is specified in the NetWare server, the IP address is specified for this machine, then this machine is running.
- 1 Log in to NetWare as an administrator from a client computer.
- 2 Start up NWadmin.
- 3 Right-click "Organization" or "Organizational unit" container where a printer agent is created, and then select "NDPS Printer" on the "Create" submenu.
- 4 In the "NDPS Printer Name" box, enter the "printer name".
- 5 In the "Printer Agent Source" column, select "Create a New Printer Agent", and then click "Create".

- 6 Check the printer agent name, and then in the "NDPS Manager Name" box, browse through the NDPS manager names, and register it.
- 7 In "Gateway Types", select "Novell Printer Gateway", and then register it.
- 8 In the "Configure Novell DPS for Printer Agent" window, select "(None)" for the printer type and "Novell Port Handler" for the port handler type, and then register the settings.
- 9 In "Connection type", select "Remote (LPR on IP)", and then register it.
- 10 Enter the IP address set for this machine as the host address, enter "Print" as the printer name, and then click the "Finish" button to register the settings.
- 11 The printer driver registration screen appears. Select "None" for each operating system to complete the registration.

### 1.25.2 NetWare Status

In Administrator mode of PageScope Web Connection, select the Network tab - "NetWare Setting" - "NetWare Status".

NetWare connection status can be checked, if necessary.

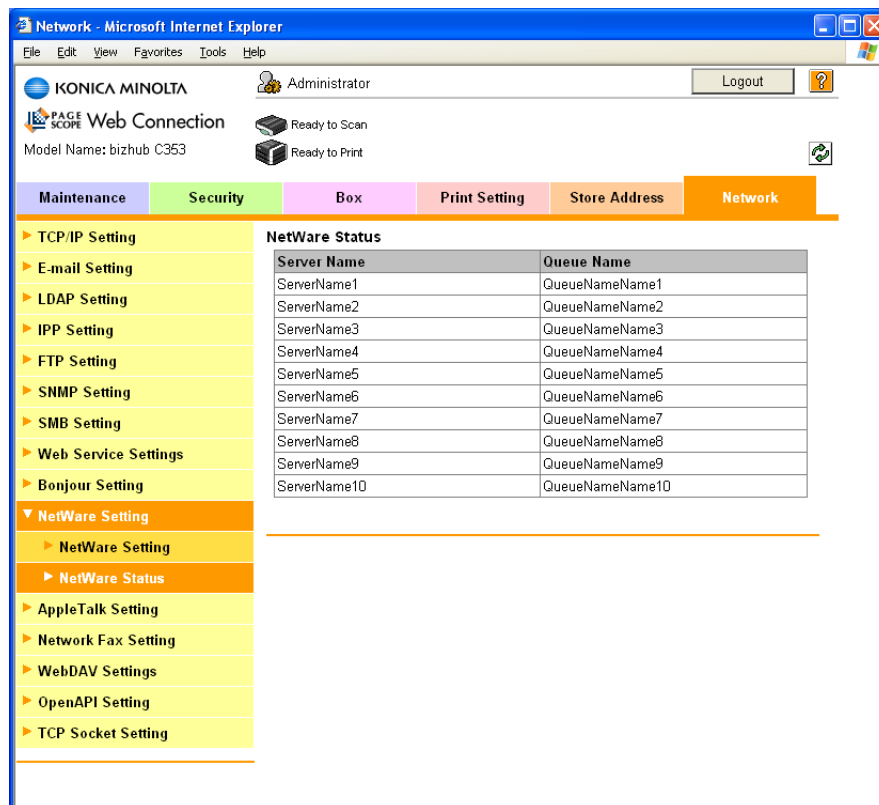

The screenshot shows the PageScope Web Connection interface in Administrator mode. The 'Network' tab is selected, and the 'NetWare Status' page is displayed. The interface includes a navigation menu on the left and a main content area with a table of NetWare status information.

Server Name	Queue Name
ServerName1	QueueNameName1
ServerName2	QueueNameName2
ServerName3	QueueNameName3
ServerName4	QueueNameName4
ServerName5	QueueNameName5
ServerName6	QueueNameName6
ServerName7	QueueNameName7
ServerName8	QueueNameName8
ServerName9	QueueNameName9
ServerName10	QueueNameName10

## 1.26 Using the WS-Print function

Specify settings for printing by using Web Service Function.

Printing is possible using the Web Service Function newly installed in Windows Vista. The Web Service Function detects this machine connected to the network, and then installs it as a WS-Printer. Specifying this machine installed as a WS-Printer when printing from Windows Vista allows printing using HTTP for communication.

Specify the settings according to the following flowchart.

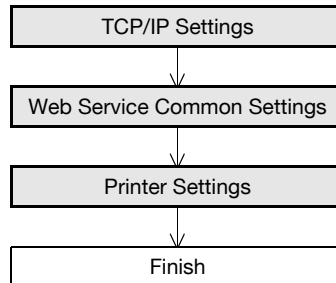

**Note**

*For details on installing the printer driver, refer to the User's Guide [Print Operations].*

### 1.26.1 TCP/IP Settings

Specify settings to use this machine in a TCP/IP network environment.

For details, refer to "[Specifying general settings for TCP/IP-based communication](#)" on page 1-2.

### 1.26.2 Web Service Common Settings

In Administrator mode of PageScope Web Connection, select the Network tab - "Web Service Settings" - "Web Service Common Settings".

Specify the following setting.

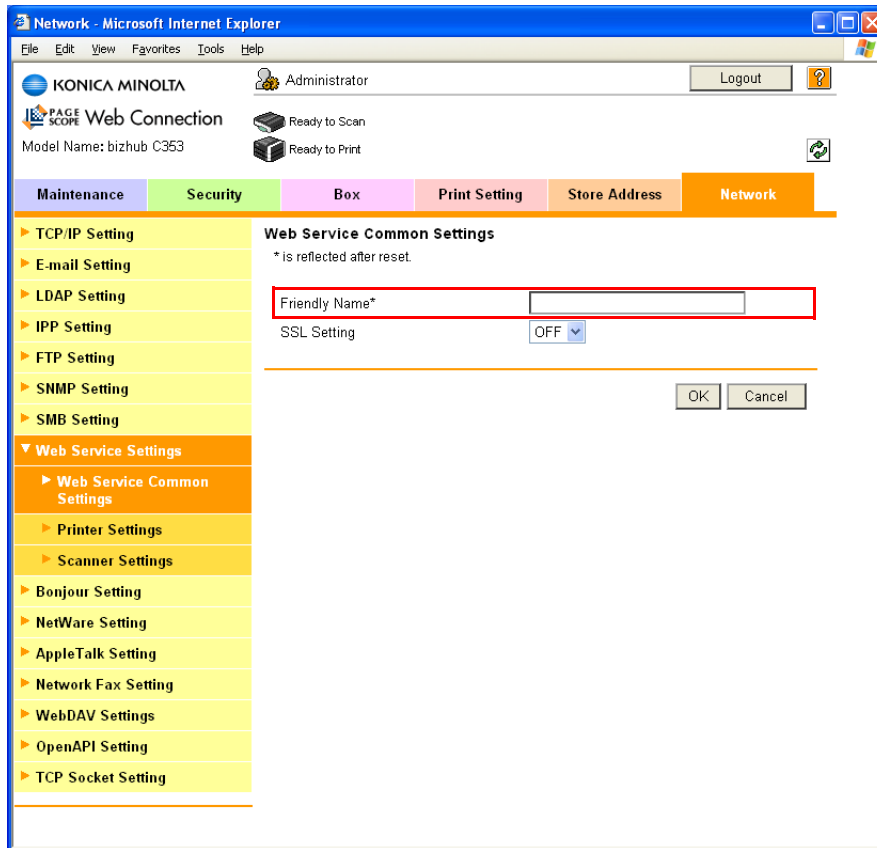

Item	Definition	Prior confirmation
Friendly Name	Specify setting for Friendly Name (up to 62 characters).	

### 1.26.3 Printer Settings

In Administrator mode of PageScope Web Connection, select the Network tab - "Web Service Settings" - "Printer Settings".

Specify the following settings.

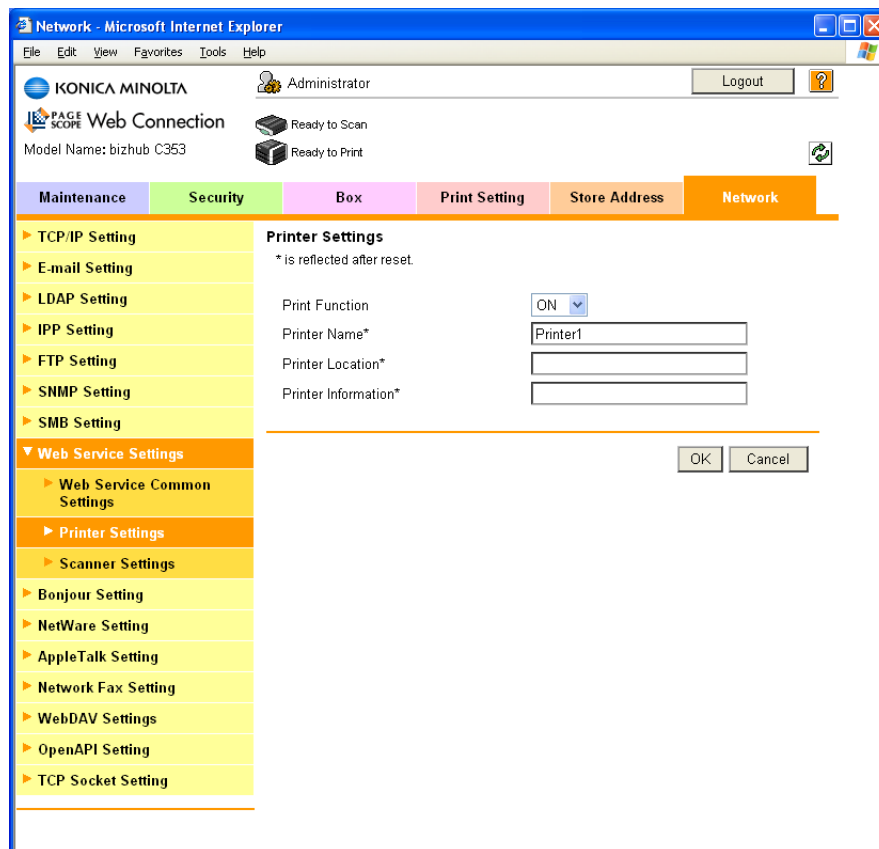

Item	Definition	Prior confirmation
Print Function	Select "ON".	
Printer Name*	Specify the printer name (up to 63 characters).	
Printer Location*	Specify the printer location (up to 63 characters).	
Printer Information*	Specify the printer information (up to 63 characters).	

## 1.27 Using the WS-Scan function

Specify settings for scanning using Web Service Function.

Data can be scanned using the Web Service Function newly installed in Windows Vista to forward the scanned data to the computer. The Web Service Function detects this machine connected to the network, and then installs it as a WS-Scanner. Specifying this machine installed as a WS-Scanner when scanning from Windows Vista allows scanning using HTTP for communication.

Specify the settings according to the following flowchart.

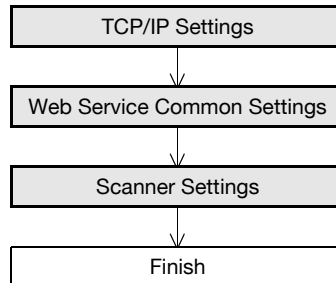

### Note

*For details on the WS-Scan function, refer to the User's Guide [Network Scan/Fax/Network Fax Operations].*

### 1.27.1 TCP/IP Settings

Specify settings to use this machine in a TCP/IP network environment.

For details, refer to "[Specifying general settings for TCP/IP-based communication](#)" on page 1-2.

## 1.27.2 Web Service Common Settings

In Administrator mode of PageScope Web Connection, select the Network tab - "Web Service Settings" - "Web Service Common Settings".

Specify the following setting.

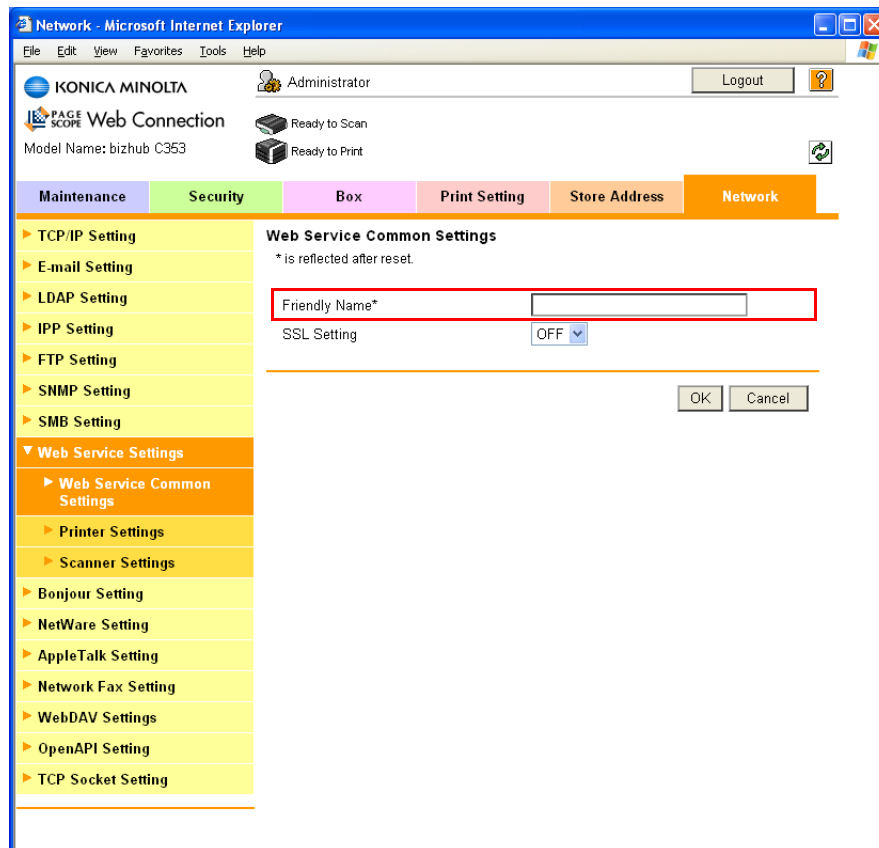

Item	Definition	Prior confirmation
Friendly Name	Specify setting for Friendly Name (up to 62 characters).	



### 1.27.3 Scanner Settings

In Administrator mode of PageScope Web Connection, select the Network tab - "Web Service Settings" - "Scanner Settings".

Specify the following settings.

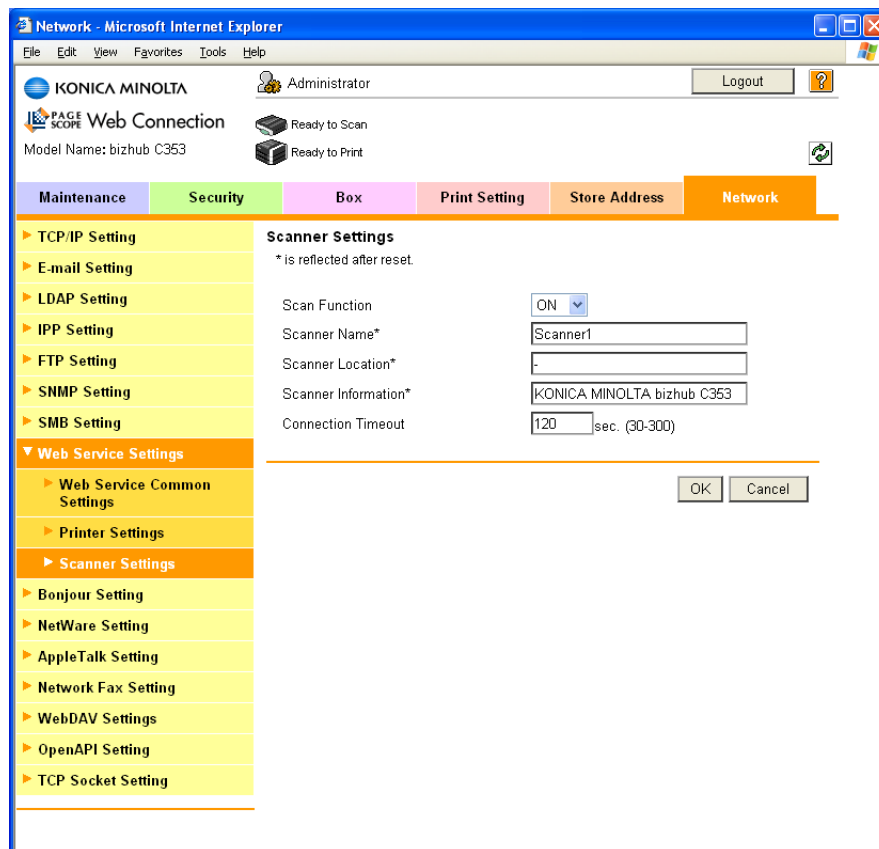

Item	Definition	Prior confirmation
Scan Function	Select "ON".	
Scanner Name*	Specify the scanner name (up to 63 characters).	
Scanner Location*	Specify the scanner location (up to 63 characters).	
Scanner Information*	Specify the scanner information (up to 63 characters).	
Connection Timeout	Specify the time period before the server connection times out.	

## 1.28 Using SSL for communication from Vista to this machine with Web Service



### Detail

To use SSL for communication between this machine and a computer, SSL communication settings must be specified on both this machine and the computer. Execute both settings described in this section and ["Using SSL for communication from this machine to Vista with Web Service" on page 1-82](#).

When using the Web Service Function, specify settings for SSL-based encryption of communication from a Windows Vista-equipped computer to this machine. These settings ensure safer file transmission by encrypting Web service-based communication using SSL.

Specify the settings according to the following flowchart.

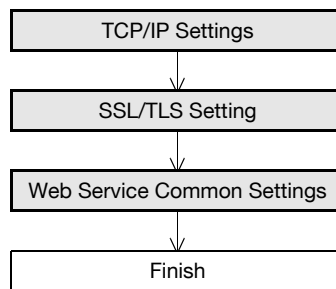

### Detail

To encrypt communication from a Windows Vista-equipped computer to this machine using SSL, the computer must be able to resolve the names for this machine using the DNS server. Register this machine to the DNS server in advance, and specify settings for DNS at the computer side.

When the certificate of this machine is not published by certificate authority, register the certificate of this machine to Windows Vista as a certificate of "Trusted Root Certification Authorities" for "Local Computer" in advance.

### 1.28.1 TCP/IP Settings

Specify settings to use this machine in a TCP/IP network environment.

For details, refer to ["Specifying general settings for TCP/IP-based communication" on page 1-2](#).

### 1.28.2 SSL/TLS Setting

Encrypt communication with this machine using SSL.

For details, refer to ["Creating a certificate for this machine for SSL-based communication" on page 1-7](#).

### 1.28.3 Web Service Common Settings

In Administrator mode of PageScope Web Connection, select the Network tab - "Web Service Settings" - "Web Service Common Settings".

Specify the following settings.

Item	Definition	Prior confirmation
Friendly Name	Specify setting for Friendly Name (up to 62 characters).	
SSL Setting	Select "Enable".	

## 1.29 Using SSL for communication from this machine to Vista with Web Service



### Detail

To use SSL for communication between this machine and a computer, SSL communication settings must be specified on both this machine and the computer. Execute both settings described in this section and ["Using SSL for communication from Vista to this machine with Web Service" on page 1-81](#).

When using the Web Service Function, specify settings for SSL-based encryption of communication from this machine to a Windows Vista-equipped computer. These settings ensure safer file transmission by encrypting Web service-based communication using SSL.

Specify the settings according to the following flowchart.

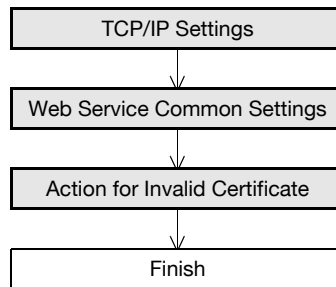

### Detail

To encrypt communication from this machine to a Windows Vista-equipped computer using SSL, create a certificate at the computer side in advance to associate the computer with the TCP/IP communication port (Default setting : Port Number 5385).

### 1.29.1 TCP/IP Settings

Specify settings to use this machine in a TCP/IP network environment.

For details, refer to ["Specifying general settings for TCP/IP-based communication" on page 1-2](#).

### 1.29.2 Web Service Common Settings

In Administrator mode of PageScope Web Connection, select the Network tab - "Web Service Settings" - "Web Service Common Settings".

Specify the following settings.

Item	Definition	Prior confirmation
Friendly Name	Specify setting for Friendly Name (up to 62 characters).	
SSL Setting	Select "Enable".	

### 1.29.3 Action for Invalid Certificate

In Administrator mode of PageScope Web Connection, select the Security tab - "SSL/TLS Setting" - "Action for Invalid Certificate".

Specify the following setting.

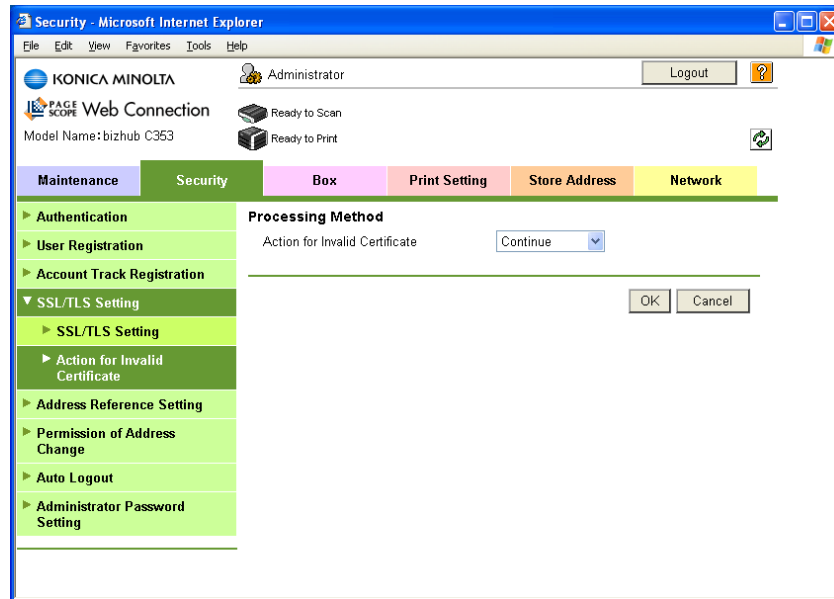

Item	Definition	Prior confirmation
Action for Invalid Certificate	Specify the operation when the validity period for the received certificate has expired. If "Continue" is selected, processing continues even if the date of the certificate is invalid. If "Delete the Job" is selected, the job is deleted if the date of the certificate is invalid.	

## 1.30 Monitoring this machine using the SNMP manager

Specify settings for monitoring this machine using the SNMP manager.

SNMP manager-based communication with this machine allows acquisition, management, and monitoring of the information of this machine via the network. SNMP runs in a TCP/IP or IPX/SPX environment.

In addition, use of the TRAP function of SNMP allows setting for notification of the status of this machine. For details, refer to ["Providing notification of the status of this machine \(TRAP\)" on page 1-90](#).

Specify the settings according to the following flowchart.

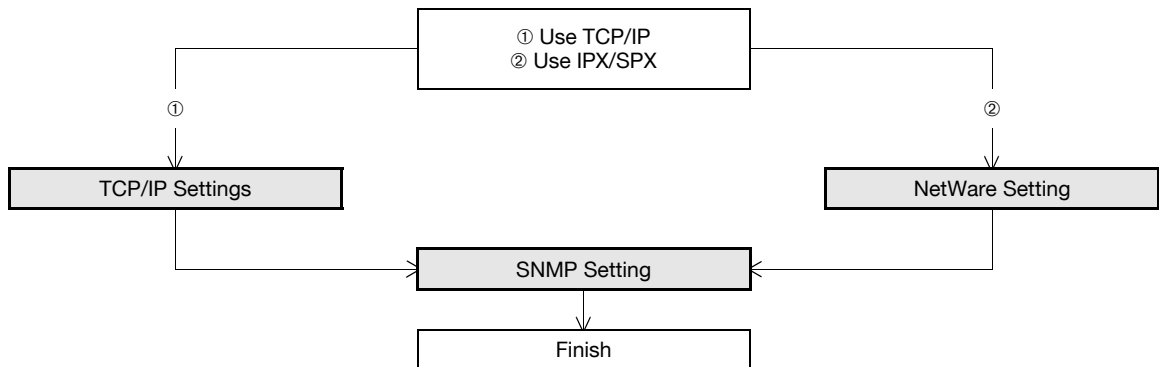

### 1.30.1 TCP/IP Settings

Specify settings to use this machine in a TCP/IP network environment.

For details, refer to ["Specifying general settings for TCP/IP-based communication" on page 1-2](#).

### 1.30.2 NetWare Setting

In Administrator mode of PageScope Web Connection, select the Network tab - "NetWare Setting" - "NetWare Setting".

Specify the following settings.

Network - Microsoft Internet Explorer

KONICA MINOLTA Administrator Logout

PageScope Web Connection Model Name: bizhub C353

Maintenance Security Box Print Setting Store Address Network

NetWare Setting

\* is reflected after reset.

IPX Setting\* ON (Turn the main switch OFF, and then ON, when changing TCP/IP.)

Ethernet Frame Type\* Auto Detect

NetWare Print Mode\* OFF

PServer

Print Server Name\*

Print Server Password\*

Polling Interval\* sec. (1-65535)

Bindery/NDS Setting\* NDS

Bindery

File Server Name\*

NDS

NDS Context Name\*

NDS Tree Name\*

Nprinter/Rprinter

Print Server Name\*

Printer Number\* 255 (0-255,255:Auto)

User Authentication Setting ON

OK Cancel

Item	Definition	Prior confirmation
IPX Setting	Select "ON".	
Ethernet Frame Type	Specify the frame type to be used.	Frame type

### 1.30.3 SNMP Setting

In Administrator mode of PageScope Web Connection, select the Network tab - "SNMP Setting".  
Specify the following settings.

The screenshot shows the 'SNMP Setting' configuration page in the PageScope Web Connection interface. The 'SNMP' checkbox is checked and set to 'ON'. Under 'SNMP v1/v2c Setting', the 'Read Community Name' is 'public' and 'Write Community Name' is 'private'. Under 'SNMP v3 Setting', the 'Context Name' is empty, 'Discovery User Name' is checked and set to 'public', 'Read User Name' is 'initial', and 'Security Level' is 'auth-password/priv-password'. The 'TRAP Setting' section shows 'Allow Setting' set to 'Allow' and 'Trap Setting when Authentication Fails' set to 'Disable'.

Item	Definition	Prior confirmation
SNMP	Specifies whether to use the SNMP. If yes, specify whether to use SNMP v1/v2 (IP), SNMP v3, and SNMP v1 (IPX). SNMP v1 (IPX) can be specified only when IPX is enabled.	Protocol to be used (TCP/IP or IPX/SPX)
UDP Port Setting	Default setting: 161 Specify the UDP port number.	
SNMP v1/v2c Setting	Specify settings for using SNMP v1/v2c.	
Read Community Name	Specify the community name to be used for scanning (up to 15 characters).	
Write Community Name	Specify the community name to be used for reading and writing (up to 15 characters).	
SNMP v3 Setting	Specify settings for SNMP v3.	
Context Name	Specify the context name (up to 63 characters).	

Item	Definition	Prior confirmation
Discovery User Name	Specify the user name for detection (up to 32 characters).	
Read User Name	Specify the name of read only user (up to 32 characters).	
Security Level	Specify the security level for read only user.	
auth-password	Specify the read only user authentication password to be used for authentication (up to 32 characters).	
priv-password	Specify the read only user privacy password to be used for privacy (encryption) (up to 32 characters).	
Write User Name	Specify the reading/writing user name (up to 32 characters).	
Security Level	Specify the security level for reading/writing user.	
auth-password	Specify the reading/writing user authentication password to be used for authentication (up to 32 characters).	
priv-password	Specify the reading/writing user privacy password to be used for privacy (encryption) (up to 32 characters).	
Encryption Algorithm	Specify the encryption algorithm.	
Authentication Method	Specify the authentication method.	

## 1.31 Providing notification of the status of this machine (E-mail)

Specify settings for notifying the administrator of the machine status via E-mail.

Using this function provides notification for a specified address when a warning message occurs on this machine.

Communication by combining POP before SMTP, APOP, SMTP authentication or encryption using SSL/TLS is available. For details, refer to ["Sending scan data by E-mail" on page 1-23](#).

Specify the settings according to the following flowchart.

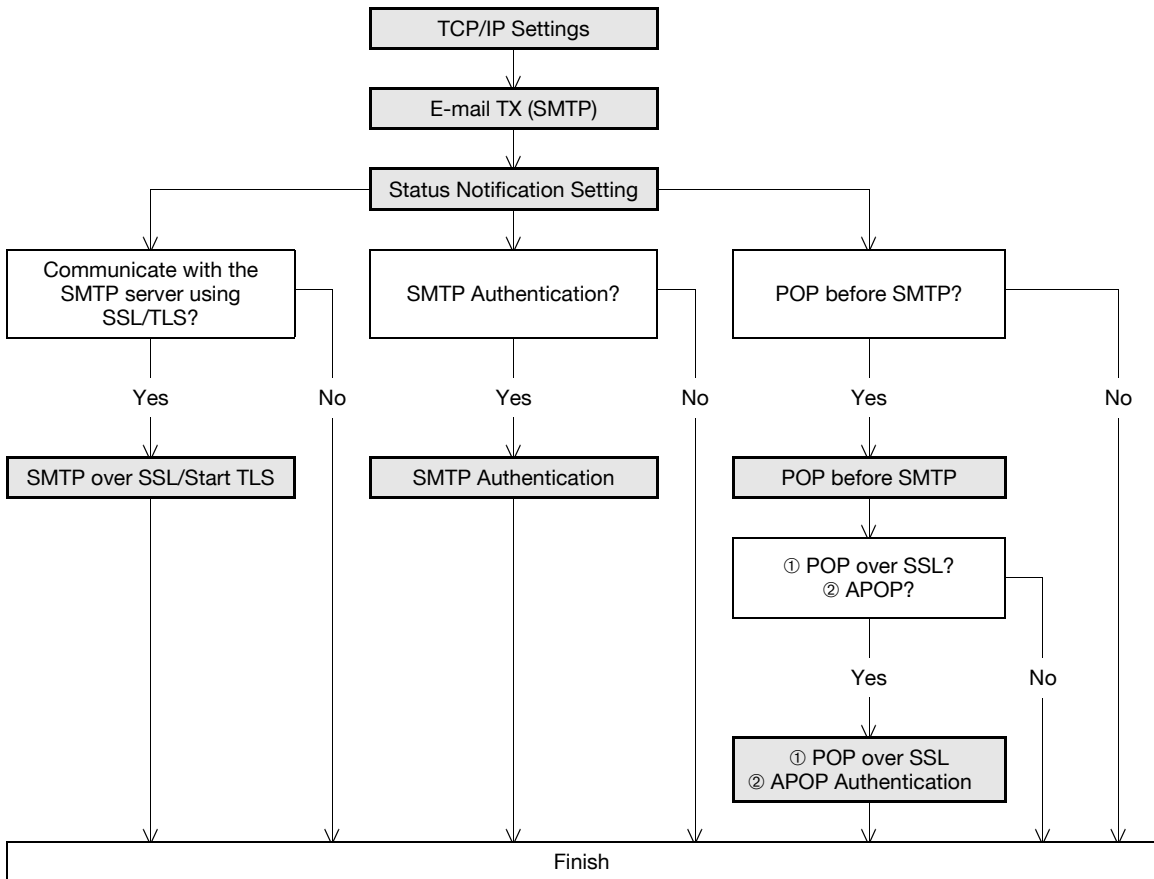

### 1.31.1 TCP/IP Settings

Specify settings to use this machine in a TCP/IP network environment.

For details, refer to ["Specifying general settings for TCP/IP-based communication" on page 1-2](#).

### 1.31.2 E-mail TX (SMTP)

In Administrator mode of PageScope Web Connection, select the Network tab - "E-mail Setting" - "E-mail TX (SMTP)".

Specify the following settings.

Item	Definition	Prior confirmation
E-mail TX Setting	Select the "E-mail TX Setting" check box.	
E-mail Notification	Select "ON".	
SMTP Server Address	Specify the SMTP server address. (Format: "****.***.***.****", Range for ***: 0 to 255) If the DNS server is specified, the address can be specified using the host name. This item can also be specified with IPv6.	Address of the server
Port Number	Default setting: 25 Specify the port number.	Port number for the server
Connection Timeout	Specify the time period before the server connection times out.	



Item	Definition	Prior confirmation
Max Mail Size	Select whether to limit the size of sent messages.	
Server Capacity	To limit the maximum mail size, specify the max. allowance of the mail size including the attached file. Mails exceeding the maximum allowance are removed. If a mail is separated, this setting is disabled.	Receiving limit of the server
Admin. E-mail Address	Displays the administrator address. If the administrator address is not specified, specify it at "Machine Setting".	Address for the administrator
Binary Division	To divide an E-Mail, select the "Binary Division" check box. If the mail software used for receiving mails does not have the mail restore function, the mails may not be read.	Restore function of the mail soft
Divided Mail Size	To divide the mail, specify a divided mail size.	Receiving limit of the server

### 1.31.3 Status Notification Setting

In Administrator mode of PageScope Web Connection, select the Maintenance tab - "Status Notification Setting" - "E-mail Address" - [Edit].

Specify the following settings.

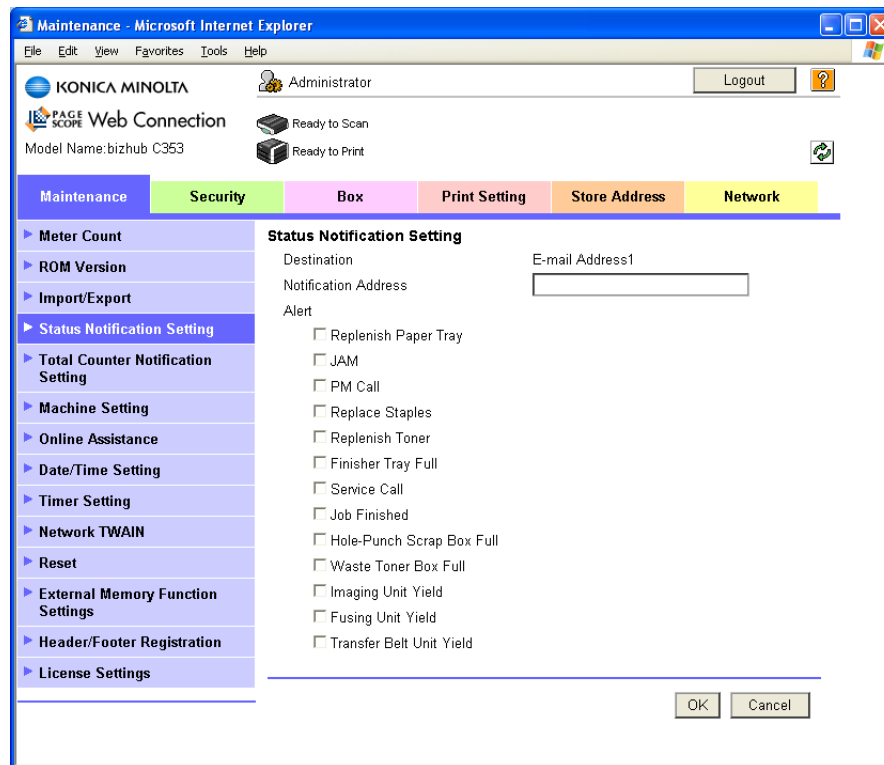

Item	Definition	Prior confirmation
Notification Address	Specify the notification address.	Notification address
Replenish Paper Tray	Provides notification when a paper-out condition occurs.	
JAM	Provides notification when a paper misfeed occurs.	
PM Call	Provides notification when a periodic inspection is required.	
Replace Staples	Provides notification when a staple-out condition occurs.	
Replenish Toner	Provides notification when a toner-out condition occurs.	
Finisher Tray Full	Provides notification when the finisher tray becomes full.	
Service Call	Provides notification when a service call occurs.	
Job Finished	Provides notification when the job is completed.	

Item	Definition	Prior confirmation
Hole-Punch Scrap Box Full	Provides notification when hole-punch scraps must be removed.	
Waste Toner Box Full	Provides notification when the waste toner box must be replaced.	
Imaging Unit Yield	Provides notification when the imaging unit must be replaced.	
Fusing Unit Yield	Provides notification when the fusing unit must be replaced.	
Transfer Belt Unit Yield	Provides notification when the transfer belt must be replaced.	

#### 1.31.4 SMTP over SSL/Start TLS

Specify the settings for SMTP over SSL/Start TLS.

For details, refer to ["SMTP over SSL/Start TLS" on page 1-26](#).

#### 1.31.5 SMTP Authentication

Specify the settings for SMTP authentication.

For details, refer to ["SMTP Authentication" on page 1-27](#).

#### 1.31.6 POP before SMTP

Specify the settings for POP before SMTP.

For details, refer to ["POP before SMTP" on page 1-27](#).

#### 1.31.7 POP over SSL

Specify the settings for POP over SSL.

For details, refer to ["POP over SSL" on page 1-29](#).

#### 1.31.8 APOP Authentication

Specify the settings for APOP authentication.

For details, refer to ["APOP Authentication" on page 1-30](#).

## 1.32 Providing notification of the status of this machine (TRAP)

Specify settings for notifying the administrator of the machine status using the TRAP function of SNMP.

Using this function provides notification for a specified IP address or IPX address when a warning message occurs on this machine.

Specify the settings according to the following flowchart.

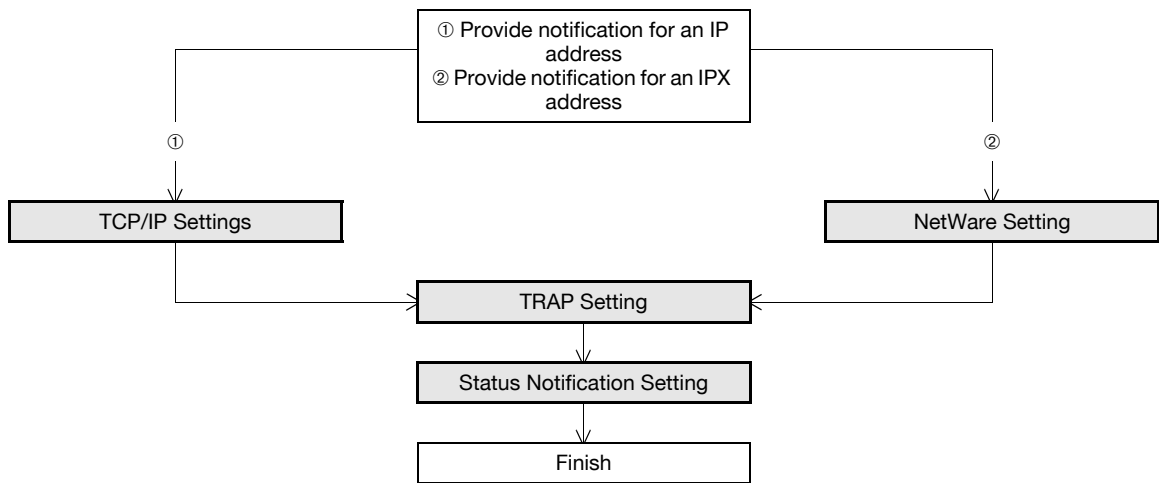

### Detail

To use the TRAP function of SNMP, specify settings for SNMP in advance. For details, refer to ["Monitoring this machine using the SNMP manager" on page 1-84](#).

### 1.32.1 TCP/IP Settings

Specify settings to use this machine in a TCP/IP network environment.

For details, refer to ["Specifying general settings for TCP/IP-based communication" on page 1-2](#).

### 1.32.2 NetWare Setting

In Administrator mode of PageScope Web Connection, select the Network tab - "NetWare Setting" - "NetWare Setting".

Specify the following settings.

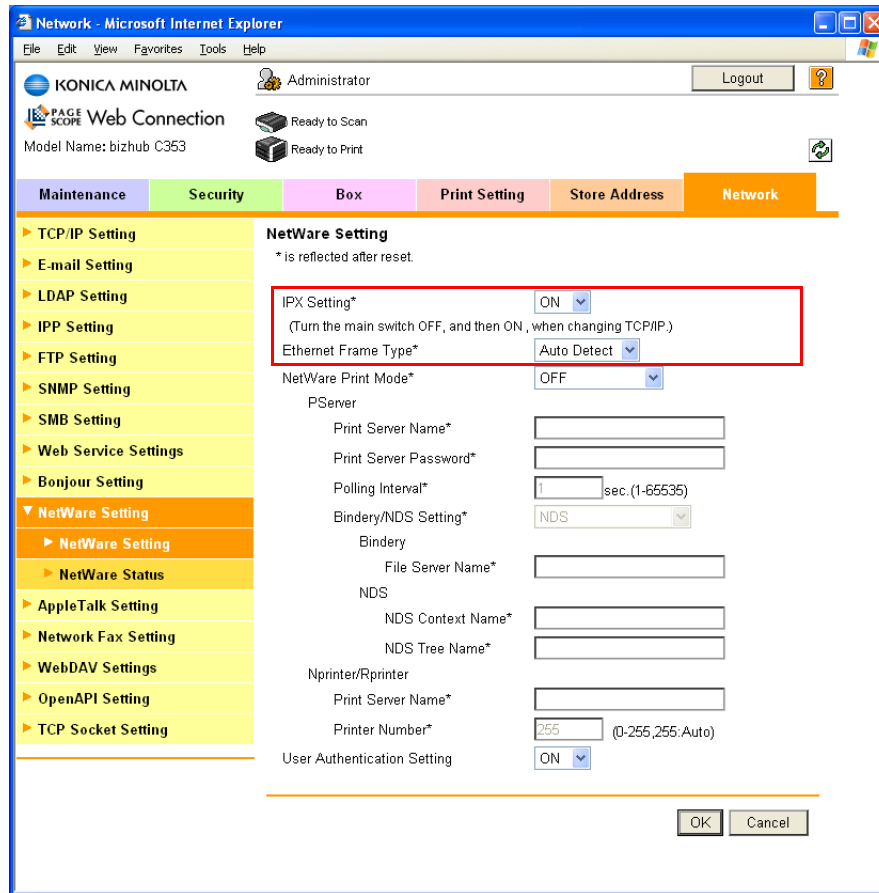

Item	Definition	Prior confirmation
IPX Setting	Select "ON".	
Ethernet Frame Type	Specify the frame type to be used.	Frame type

### 1.32.3 TRAP Setting

In Administrator mode of PageScope Web Connection, select the Network tab - "SNMP Setting".

Specify the following settings.

Item	Definition	Prior confirmation
Allow Setting	Select "Allow".	
Trap Setting when Authentication Fails	Select whether to enable the TRAP function when authentication failed.	

### 1.32.4 Status Notification Setting

In Administrator mode of PageScope Web Connection, select the Maintenance tab - "Status Notification Setting" - "IP (IPX) Address" - [Edit].

For details on the settings, refer to ["Status Notification Setting" on page 1-88](#).

### 1.33 Providing notification of the counter information of this machine via E-mail

Specify settings for providing notification of counter information of this machine via E-mail.

Using this function provides notification of counter information managed by this machine for a specified address. The counter of this machine can be checked by selecting PageScope Web Connection - Maintenance tab - "Meter Count".

Communication by combining POP before SMTP, APOP, SMTP authentication or encryption using SSL/TLS is available. For details, refer to ["Sending scan data by E-mail" on page 1-23](#).

Specify the settings according to the following flowchart.

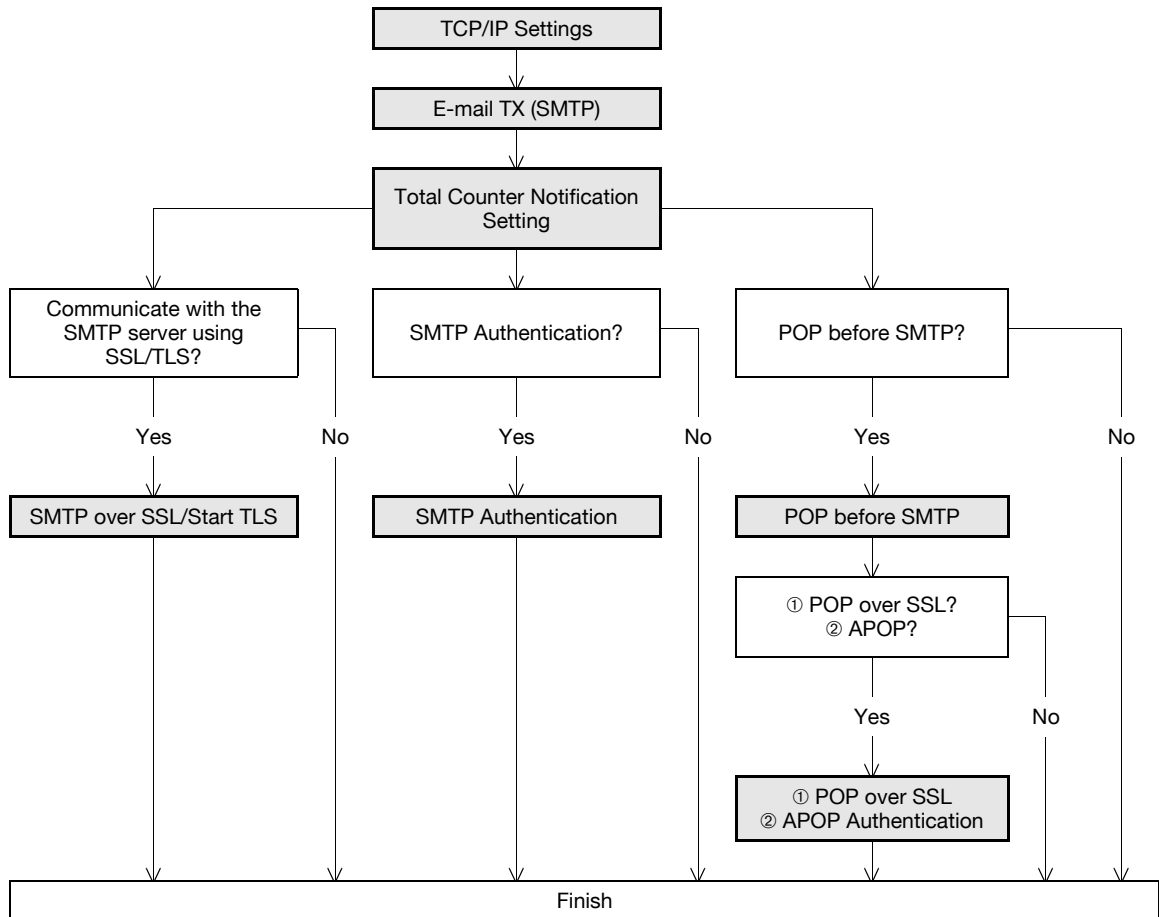

#### 1.33.1 TCP/IP Settings

Specify settings to use this machine in a TCP/IP network environment.

For details, refer to ["Specifying general settings for TCP/IP-based communication" on page 1-2](#).

### 1.33.2 E-mail TX (SMTP)

In Administrator mode of PageScope Web Connection, select the Network tab - "E-mail Setting" - "E-mail TX (SMTP)".

Specify the following settings.

Item	Definition	Prior confirmation
E-mail TX Setting	Select the "E-mail TX Setting" check box.	
Total Counter Notification	Select "ON".	
SMTP Server Address	Specify the SMTP server address. (Format: "****.***.***.****", Range for ***: 0 to 255) If the DNS server is specified, the address can be specified using the host name. This item can also be specified with IPv6.	Address of the server
Port Number	Default setting: 25 Specify the port number.	Port number for the server
Connection Timeout	Specify the time period before the server connection times out.	
Max Mail Size	Select whether to limit the size of sent messages.	
Server Capacity	To limit the maximum mail size, specify the max. allowance of the mail size including the attached file. Mails exceeding the maximum allowance are removed. If a mail is separated, this setting is disabled.	Receiving limit of the server
Admin. E-mail Address	Displays the administrator address. If the administrator address is not specified, specify it at "Machine Setting".	Address for the administrator
Binary Division	To divide an E-Mail, select the "Binary Division" check box. If the mail software used for receiving mails does not have the mail restore function, the mails may not be read.	Restore function of the mail soft
Divided Mail Size	To divide the mail, specify a divided mail size.	Receiving limit of the server

### 1.33.3 Total Counter Notification Setting

In Administrator mode of PageScope Web Connection, select the Maintenance tab - "Total Counter Notification Setting".

Specify the following settings.

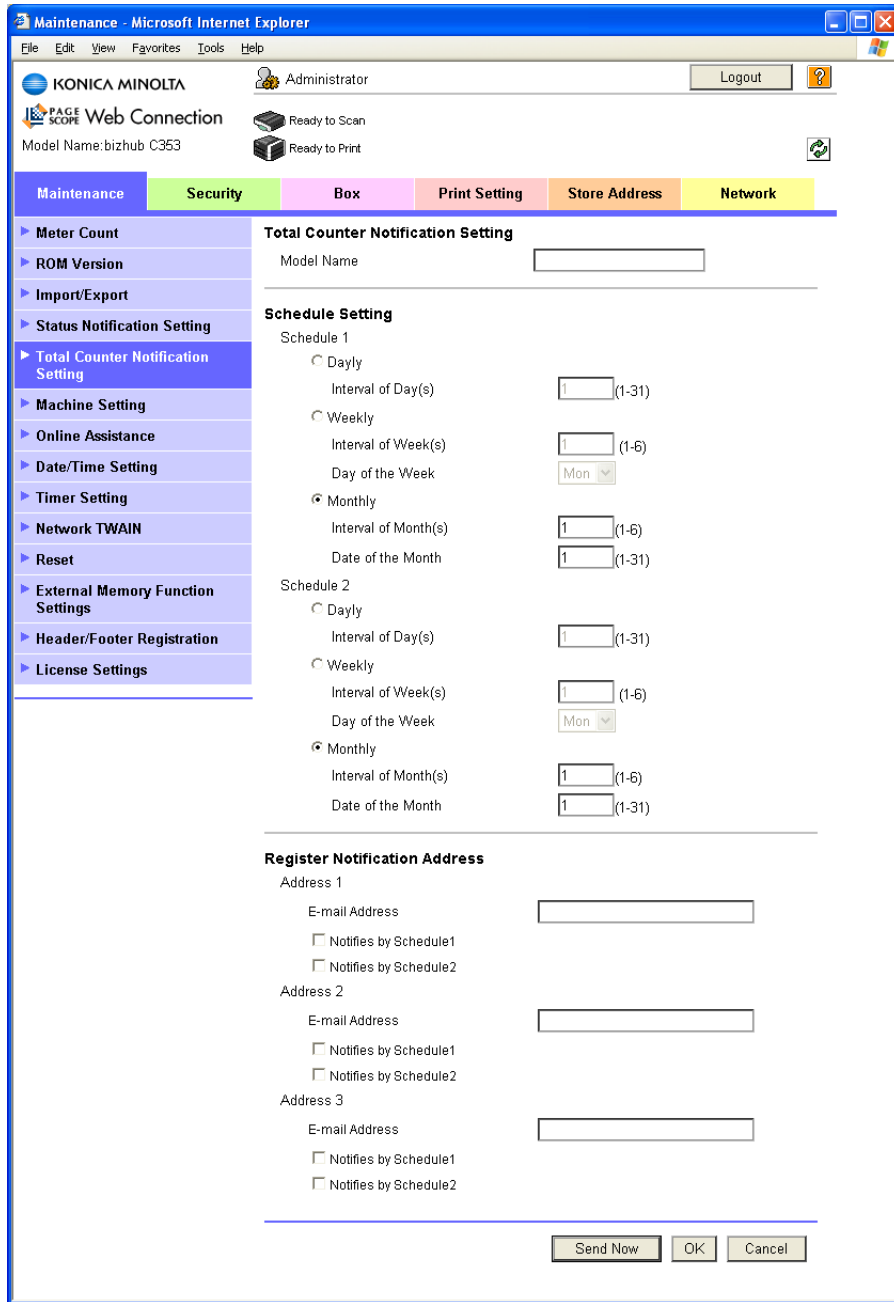

Item	Definition	Prior confirmation
Model Name	Specify the model name indicated in the notification message (up to 20 characters).	
Schedule Setting	Specify the conditions for the notification schedule. Schedules 1 and 2 can be registered with different settings.	Notification schedule
Register Notification Address	Specify the notification addresses (up to 320 characters). Select the desired notification schedule.	Notification address

### 1.33.4 SMTP over SSL/Start TLS

Specify the settings for SMTP over SSL/Start TLS.

For details, refer to "SMTP over SSL/Start TLS" on page 1-26.

### 1.33.5 SMTP Authentication

Specify the settings for SMTP authentication.

For details, refer to ["SMTP Authentication" on page 1-27](#).

### 1.33.6 POP before SMTP

Specify the settings for POP before SMTP.

For details, refer to ["POP before SMTP" on page 1-27](#).

### 1.33.7 POP over SSL

Specify the settings for POP over SSL.

For details, refer to ["POP over SSL" on page 1-29](#).

### 1.33.8 APOP Authentication

Specify the settings for APOP authentication.

For details, refer to ["APOP Authentication" on page 1-30](#).

### 1.33.9 Meter Count

In Administrator mode of PageScope Web Connection, select the Maintenance tab - "Meter Count".

The counter information managed by the machine can be displayed.

The screenshot shows the 'Maintenance' tab selected in the PageScope Web Connection interface. The 'Meter Count' section is expanded, showing the following data:

Total Counter	
Total	0
Total Duplex	0
# of Originals	0
# of Used Paper	0

Copy Counter					
	Full Color	Black	Single Color	2 Color	Total
Total	0	0	0	0	0
Large Size	0	0	0	0	0

Print Counter				
	Full Color	Black	2 Color	Total
Total	0	0	0	0
Large Size	0	0	0	0

Scan / Fax Counter			
	Print (Full Color)	Print (Black)	Scans
Total	0	0	0
Large Size	0	0	0

Fax TX	0
Fax RX	0

Total (Copy + Print)			
	Full Color	Black	2 Color
Total	0	0	0

Paper Size / Type Counter		
Paper Size	Paper Type	Count
A3	Not Specified	0
B4	Not Specified	0
A4	Not Specified	0
B5	Not Specified	0
A5	Not Specified	0
8" x 13"	Not Specified	0
BK	Not Specified	0
16K	Not Specified	0
B6	Not Specified	0
Others	Not Specified	0



## 1.34 Limiting users using this machine (Machine authentication)

Specify settings for using this machine using machine authentication.

Specify user authentication and account track settings in order to control the use of this machine. User authentication settings are specified to manage individuals, and account track settings are specified to manage groups and multiple users. By specifying both user authentication and account track settings, the number of prints made by each account can be managed for each individual user.

Specify the settings according to the following flowchart.

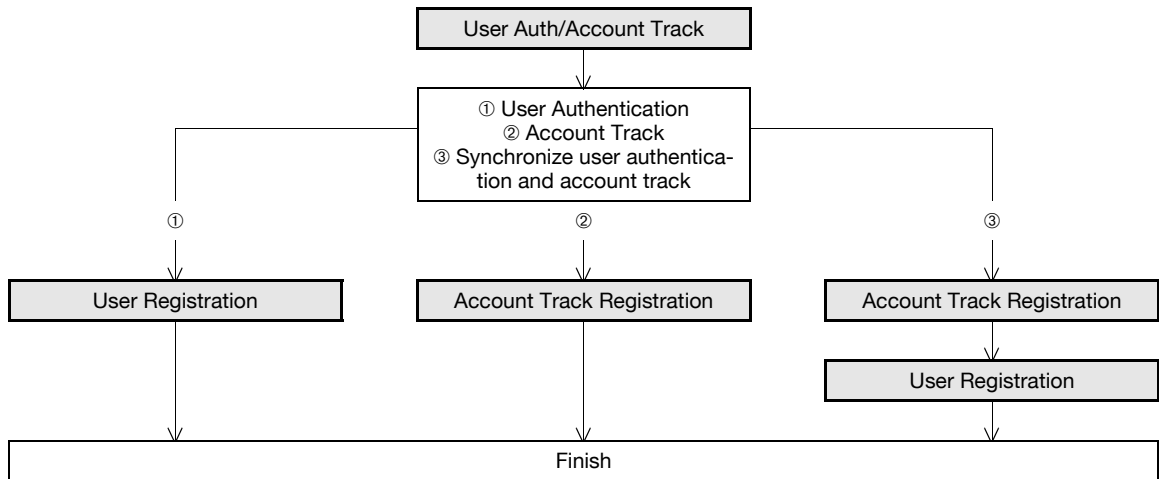

**Note**

*For details on the machine authentication, refer to the User's Guide [Copy Operations].*

### 1.34.1 User Auth/Account Track

In Administrator mode of PageScope Web Connection, select the Security tab - "Authentication" - "User Auth/Account Track".

Specify the following settings.



**Detail**

*If authentication is performed with PageScope Authentication Manager, this menu item does not appear.*

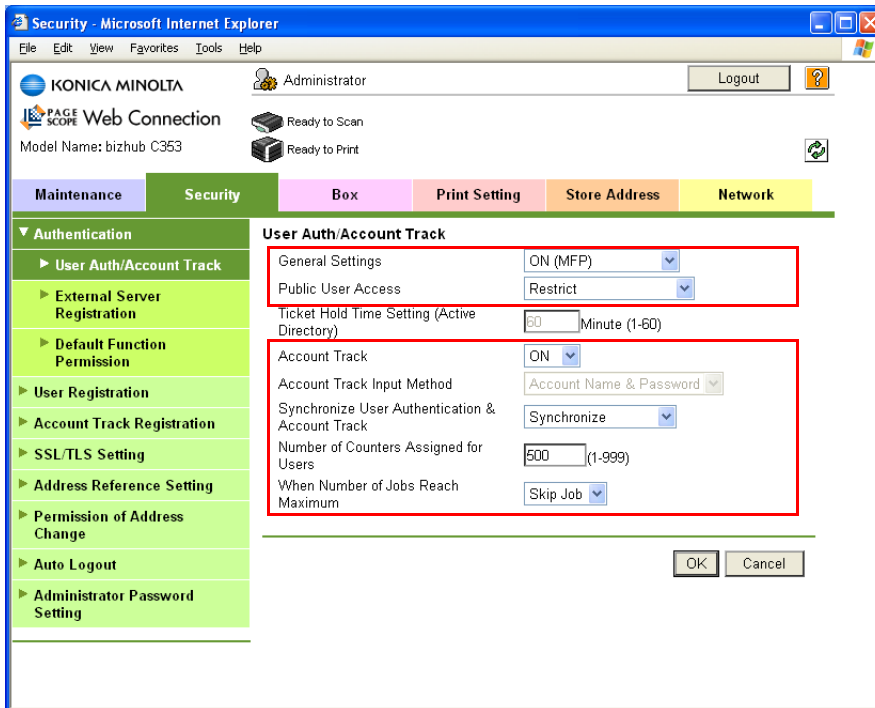

Item	Definition	Prior confirmation
General Settings	Select "ON (MFP)".	
Public User Access	Specify whether to allow public users.	Whether to allow public users
Account Track	To use the account track function, select "ON".	Whether to use Account Track
Account Track Input Method	To use the account track function, select the desired authentication method.	
Synchronize User Authentication & Account Track	To synchronize user authentication and account track functions, select "Synchronize".	Whether to synchronize the user authentication and account track functions
Number of Counters Assigned for Users	To use the user authentication and account track, specify the number of counters assigned for users.	
When Number of Jobs Reach Maximum	Specify the operation that is performed when the number of copies or printouts have reached its maximum.	



**Detail**

*If Enhanced Security Mode is set to "ON", the authentication method cannot be set to "OFF". In addition, "Public User Access" is set to "Restrict".*

### 1.34.2 User Registration

In Administrator mode of PageScope Web Connection, select the Security tab - "User Registration" - [New Registration].

Specify the following settings.



**Detail**

*If authentication is performed with PageScope Authentication Manager, this menu item does not appear.*

The screenshot shows the 'Security - Microsoft Internet Explorer' window with the 'User Registration' configuration page. The page is divided into several sections:

- User Registration:** Fields for No., User Name, E-mail Address, User Password, and Retype User Password.
- Function Permission:** A list of functions with 'Allow' dropdown menus: Copy, Scan, Save to External Memory, Fax, Print, User Box, Print Scan/Fax from User Box, and Manual Destination Input.
- Output Permission(Print):** 'Color' and 'Black' with 'Allow' dropdown menus.
- Output Permission(TX):** 'Color' with an 'Allow' dropdown menu.
- Max. Allowance Set:**
  - Total Allowance:  Total, value: 1 (1-9999999)
  - Individual Allowance:
    - Color, value: 1 (1-9999999)
    - Black, value: 1 (1-9999999)
  - Box Administration:  Box Count, value: 1 (0-1000)
- Limiting Access to Destinations:**
  - Reference Allowed Group: Search from List, Registered Reference Group Number (Total: 0)
  - Access Allowed Level: 0

Buttons for 'OK' and 'Cancel' are located at the bottom right of the form.

Item	Definition	Prior confirmation
No.	Enter the registration number.	
User Name	Enter the user name.	
E-mail Address	Enter the E-mail address.	
User Password	Enter the password.	
Retype User Password	Enter the password again.	
Account Name	Register the account to which the user belongs. Before selecting the account name, register the account. When synchronization of the user authentication and account is specified, this item appears.	
Specify Icon	From [Search from List], specify an icon for the user to be registered.	
Function Permission	Specify whether to allow copy operations, scan operations, saving to external memory, fax operations, printing, user box operation, print scan/fax from user box, and manual destination input.	
Output Permission (Print)	Specify whether to allow color or black output when printing.	
Output Permission (TX)	Specify whether to allow sending color images.	
Max. Allowance Set	Specify whether to limit the max. allowance of output.	
Limiting Access to Destinations	Specify the destination access right of users to be registered. When "Reference Allowed Group" is selected, click [Search from List], and then select a reference allowed group from the list. When "Access Allowed Level" is selected, specify a level.	



#### Detail

*If "Password Rules" is enabled, no password containing less than eight characters can be registered. If you have already registered a user password containing less than eight characters, change it to one using eight characters before enabling "Password Rules". For details on the password rules, refer to the User's Guide [Copy Operations].*

*For details on limiting access to destinations, refer to ["Limiting accessible destinations by user" on page 1-142](#).*

### 1.34.3 Account Track Registration

In Administrator mode of PageScope Web Connection, select the Security tab - "Account Track Registration" - [New Registration].

Specify the following settings.



#### Detail

*If authentication is performed with PageScope Authentication Manager, this menu item does not appear.*

The screenshot shows the 'Account Track Registration' form with the following fields and options:

- Registration Fields:** No., Account Name, Password, Retype Password.
- Output Permission(Print):** Color (Allow), Black (Allow).
- Output Permission(TX):** Color (Allow).
- Max. Allowance Set:**
  - Total Allowance:  Total (1-9999999)
  - Individual Allowance:
    - Color (1-9999999)
    - Black (1-9999999)
  - Box Administration:
    - Box Count (0-1000)

Buttons: OK, Cancel

Item	Definition	Prior confirmation
No.	Enter the registration number.	
Account Name	Enter the account name.	
Password	Enter the password.	
Retype Password	Enter the password again.	
Output Permission (Print)	Specify whether to allow color or black output when printing.	
Output Permission (TX)	Specify whether to allow sending color images.	
Max. Allowance Set	Displays whether to limit the max. allowance of output.	

**Detail**

*If "Password Rules" is enabled, no password containing less than eight characters can be registered. If you have already registered a user password containing less than eight characters, change it to one using eight characters before enabling "Password Rules". For details on the password rules, refer to the User's Guide [Copy Operations].*

## 1.35 Limiting users using this machine (Active Directory)

Specify settings for limiting users of this machine using Active Directory.

To perform authentication using Active Directory of Windows 2000 Server or Windows 2003 Server, use this setting. This setting limits functions available on a user basis.

Specify the settings according to the following flowchart.

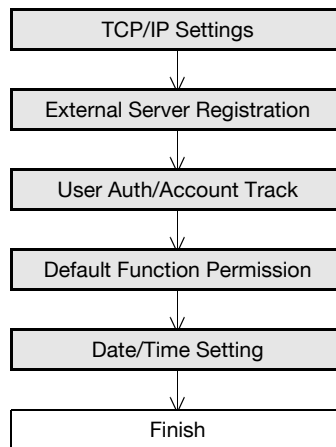

### 1.35.1 TCP/IP Settings

Specify settings to use this machine in a TCP/IP network environment.

When using Active Directory, specify a DNS server synchronized with Active Directory in the DNS Server Settings of this machine.

For details, refer to "[Specifying general settings for TCP/IP-based communication](#)" on page 1-2.

## 1.35.2 External Server Registration

In Administrator mode of PageScope Web Connection, select the Security tab - "Authentication" - "External Server Registration" - [Edit].

Specify the following settings.

The screenshot shows the 'External Server Registration' configuration page. The 'No.' field is set to 1. The 'External Server Name' field is empty. The 'External Server Type' is set to 'Active Directory'. The 'Active Directory' checkbox is checked. The 'Default Domain Name' field is empty. The 'NTLM' checkbox is unchecked. The 'Default Domain Name' field is empty. The 'NDS' checkbox is unchecked. The 'Default NDS Tree Name' field is empty. The 'Default NDS Context Name' field is empty. The 'LDAP' checkbox is unchecked. The 'Server Address' checkbox is checked, with the text 'Please check to enter host name.' below it. The 'Port No.' field is set to 389. The 'Port No. (SSL)' field is set to 336. The 'Search Base' field is empty. The 'Timeout' field is set to 30 sec. The 'Authentication Method' is set to Simple. The 'Search Attribute' field is set to uid. The 'OK' and 'Cancel' buttons are at the bottom right.

Item	Definition	Prior confirmation
No.	Displays the registration number.	
External Server Name	Enter the name of the external authentication server (up to 32 characters).	
External Server Type	Select "Active Directory".	
Default Domain Name	Enter the default domain name.	Default domain name



### 1.35.3 User Auth/Account Track

In Administrator mode of PageScope Web Connection, select the Security tab - "Authentication" - "User Auth/Account Track".

Specify the following settings.



#### Detail

*If authentication is performed with PageScope Authentication Manager, this menu item does not appear.*

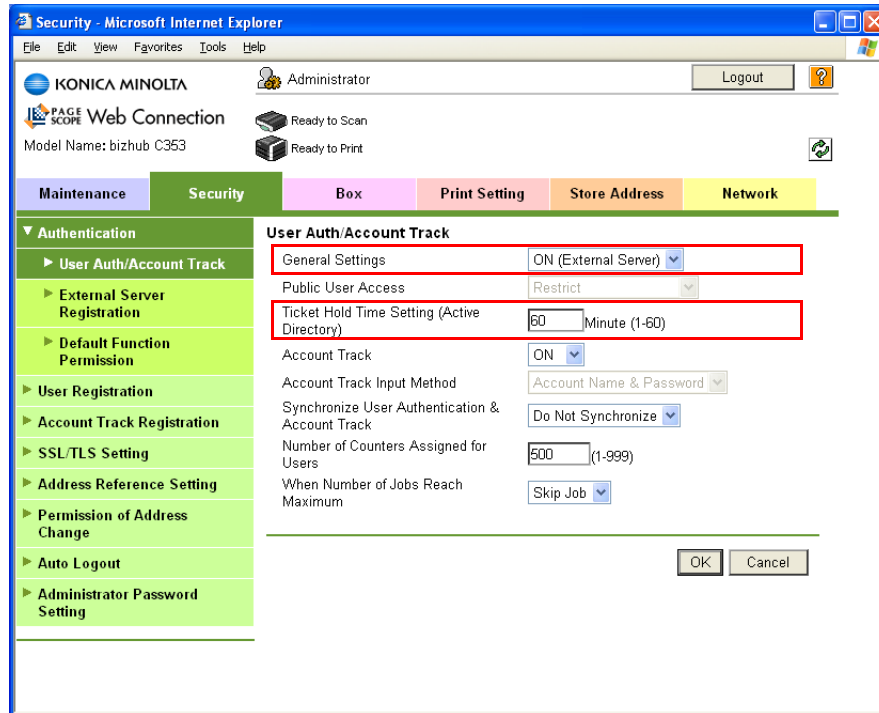

Item	Definition	Prior confirmation
General Settings	Select "ON (External Server)".	
Ticket Hold Time Setting (Active Directory)	Specify the ticket hold time.	

### 1.35.4 Default Function Permission

In Administrator mode of PageScope Web Connection, select the Security tab - "Authentication" - "Default Function Permission".

Specify the following settings.



**Detail**

*If authentication is performed with PageScope Authentication Manager, this menu item does not appear.*

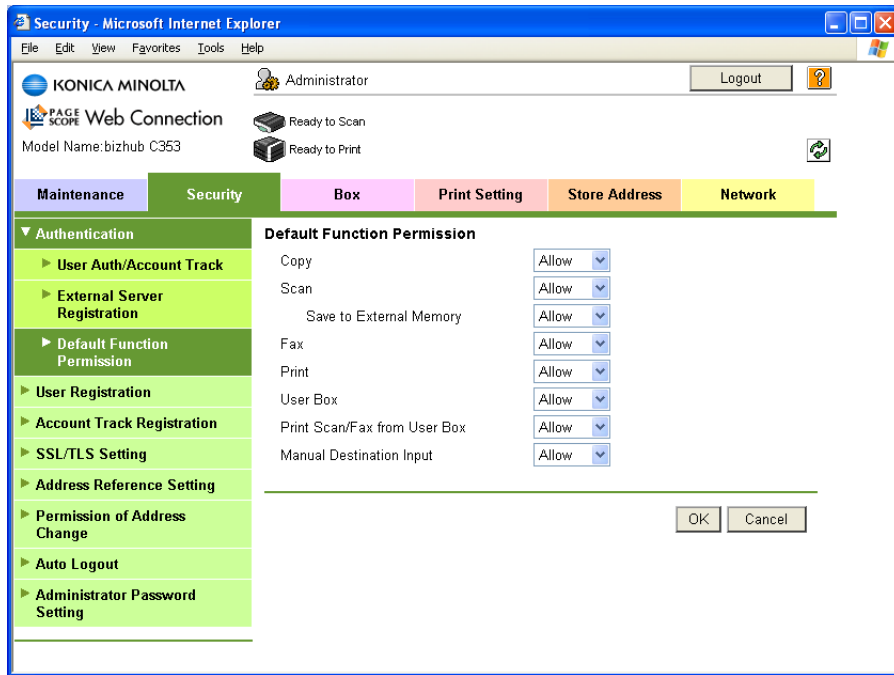

Item	Definition	Prior confirmation
Copy	Limits functions available to authorized users on this machine. Specify whether to allow each function.	
Scan		
Save to External Memory		
Fax		
Print		
User Box		
Print Scan/Fax from User Box		
Manual Destination Input		

### 1.35.5 Date/Time Setting

When using Active Directory, specify the date and time on this machine.

For details, refer to "[Specifying the date and time on this machine](#)" on page 1-16.

## 1.36 Limiting users using this machine (Windows domain/workgroup)

Specify settings for limiting users of this machine using NTLM authentication.

To perform authentication using NTLM when using Windows NT4.0 or using Active Directory of Windows 2000 Server or Windows Server 2003, use this setting. This setting limits functions available on a user basis.

This machine supports the direct hosting service. To execute NTLM authentication in the IPv6 environment, the Direct Hosting setting must be enabled. When the Direct Hosting setting is enabled, this machine acquires the IPv6 address of the Windows server using the DNS server.

Specify the settings according to the following flowchart.

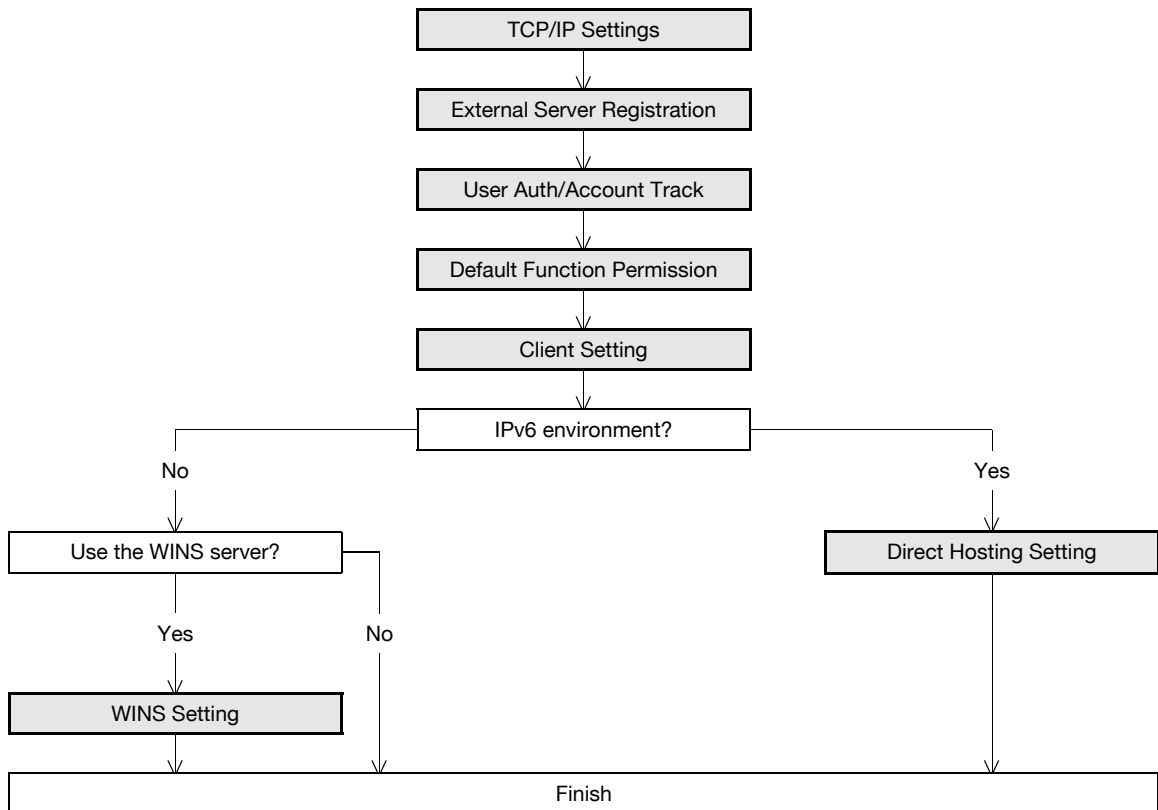

### 1.36.1 TCP/IP Settings

Specify settings to use this machine in a TCP/IP network environment.

To execute NTLM authentication in the IPv6 environment, the Direct Hosting setting must be enabled. Prepare a DNS server and be sure to specify the DNS settings of this machine correctly.

For details, refer to "[Specifying general settings for TCP/IP-based communication](#)" on page 1-2.

## 1.36.2 External Server Registration

In Administrator mode of PageScope Web Connection, select the Security tab - "Authentication" - "External Server Registration" - [Edit].

Specify the following settings.

Item	Definition	Prior confirmation
No.	Displays the registration number.	
External Server Name	Enter the name of the external authentication server (up to 32 characters).	
External Server Type	Select "NTLM v1" or "NTLM v2". NTLMv2 is applied from Windows NT 4.0 (Service Pack 4).	
Default Domain Name	Enter the default domain name. Enter the default domain name in uppercase letters.	Default domain name

### 1.36.3 User Auth/Account Track

In Administrator mode of PageScope Web Connection, select the Security tab - "Authentication" - "User Auth/Account Track".

Specify the following setting.



#### Detail

*If authentication is performed with PageScope Authentication Manager, this menu item does not appear.*

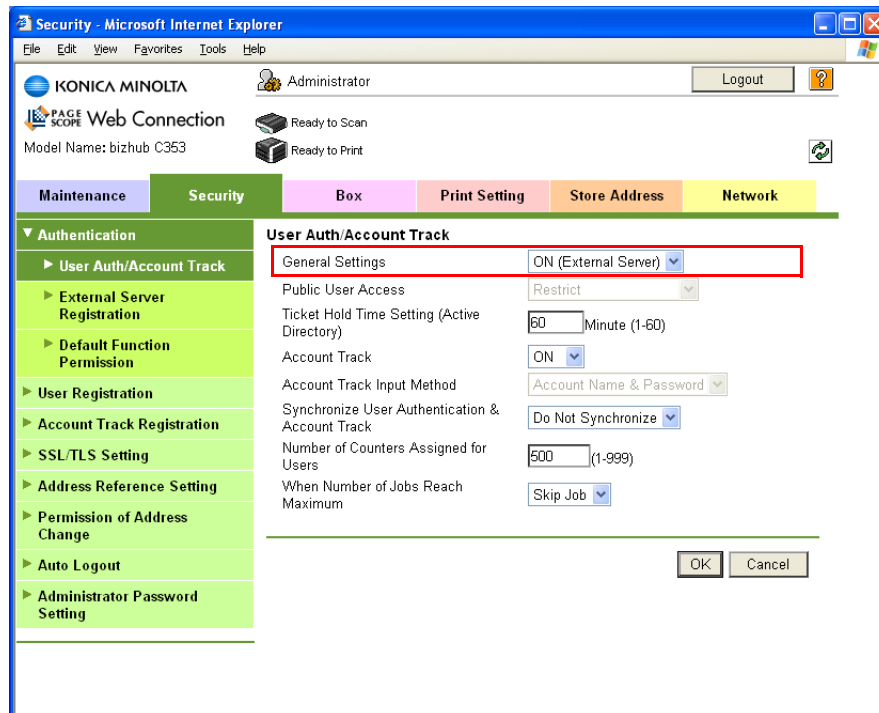

Item	Definition	Prior confirmation
General Settings	Select "ON (External Server)".	

### 1.36.4 Default Function Permission

Limits functions available to authorized users on this machine.

For details, refer to "[Default Function Permission](#)" on page 1-105.

### 1.36.5 Client Setting

In Administrator mode of PageScope Web Connection, select the Network tab - "SMB Setting" - "Client Setting".

Specify the following setting.

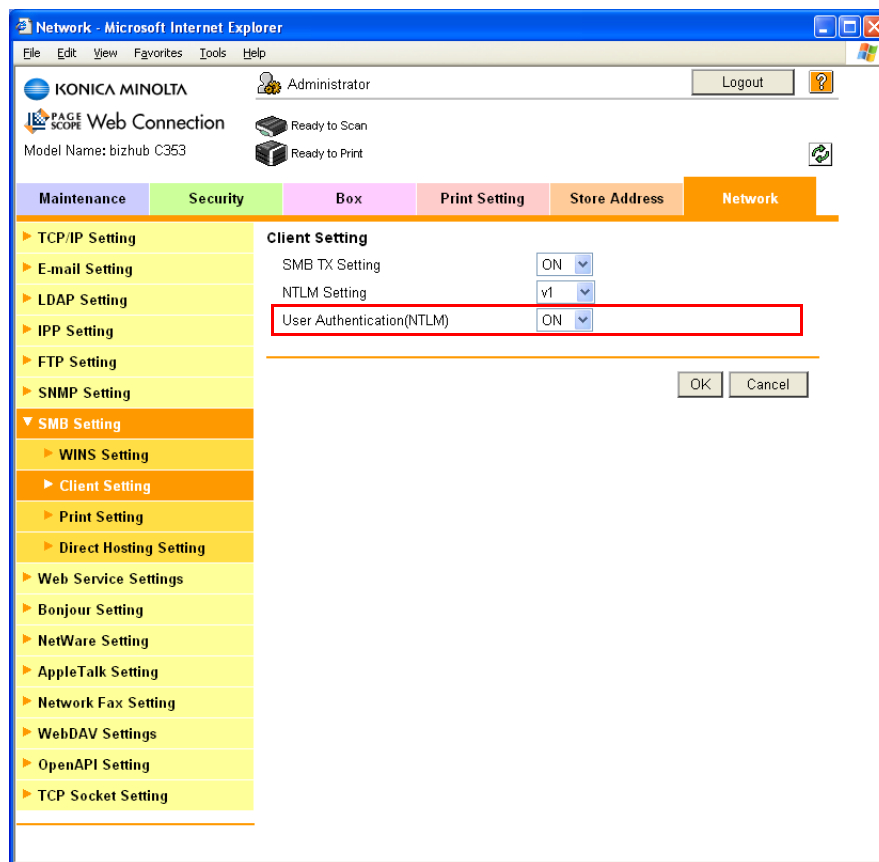

Item	Definition	Prior confirmation
User Authentication (NTLM)	Select "ON".	



#### Detail

Specifying "OFF" for "User authentication (NTLM)" synchronizes with the user authentication setting, switching to "ON (MFP)".

### 1.36.6 WINS Setting

To use the WINS server, specify settings for the WINS server.

For details, refer to ["WINS Setting" on page 1-22](#).

### 1.36.7 Direct Hosting Setting

To execute NTLM authentication in the IPv6 environment, enable the Direct Hosting setting.

For details, refer to ["Direct Hosting Setting" on page 1-21](#).

## 1.37 Limiting users using this machine (NDS)

Specify settings for limiting users of this machine using NDS.

To perform NDS-based authentication using NetWare 5.1 or NetWare 6.0, use this setting. This setting limits functions available on a user basis.

Specify the settings according to the following flowchart.

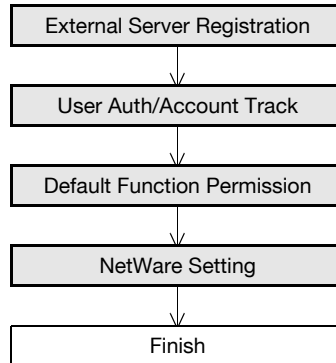

### Detail

*NDS is available only when IPX is used as the protocol. NDS is not available when IP is used.*

### 1.37.1 External Server Registration

In Administrator mode of PageScope Web Connection, select the Security tab - "Authentication" - "External Server Registration" - [Edit].

Specify the following settings.

The screenshot displays the 'External Server Registration' configuration page. The 'External Server Type' is set to 'NDS'. The 'NDS' section includes fields for 'Default NDS Tree Name' and 'Default NDS Context Name'. The 'LDAP' section includes fields for 'Server Address', 'Port No.' (389), 'Port No. (SSL)' (636), 'Search Base', 'Timeout' (30 sec), 'Authentication Method' (Simple), and 'Search Attribute' (uid). The 'OK' and 'Cancel' buttons are visible at the bottom right.

Item	Definition	Prior confirmation
No.	Displays the registration number.	
External Server Name	Enter the name of the external authentication server (up to 32 characters).	
External Server Type	Select "NDS".	
Default NDS Tree Name	Enter the default NDS tree name.	
Default NDS Context Name	Enter the default NDS context name.	

### 1.37.2 User Auth/Account Track

In Administrator mode of PageScope Web Connection, select the Security tab - "Authentication" - "User Auth/Account Track".

Specify the following setting.



#### Detail

*If authentication is performed with PageScope Authentication Manager, this menu item does not appear.*

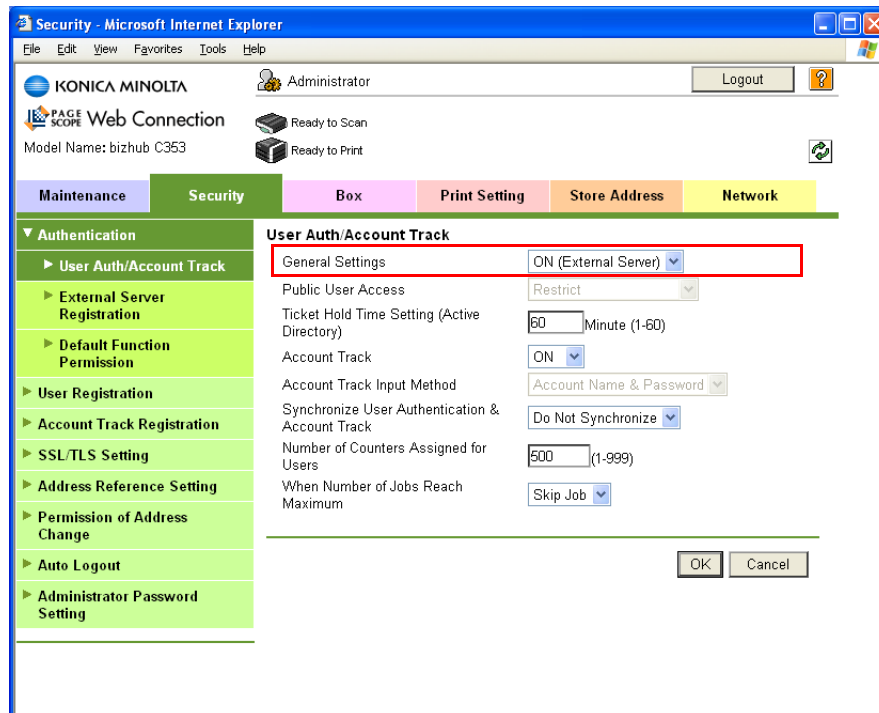

Item	Definition	Prior confirmation
General Settings	Select "ON (External Server)".	

### 1.37.3 Default Function Permission

Limits functions available to authorized users on this machine.

For details, refer to "[Default Function Permission](#)" on page 1-105.



### 1.37.4 NetWare Setting

In Administrator mode of PageScope Web Connection, select the Network tab - "NetWare Setting" - "NetWare Setting".

Specify the following settings.

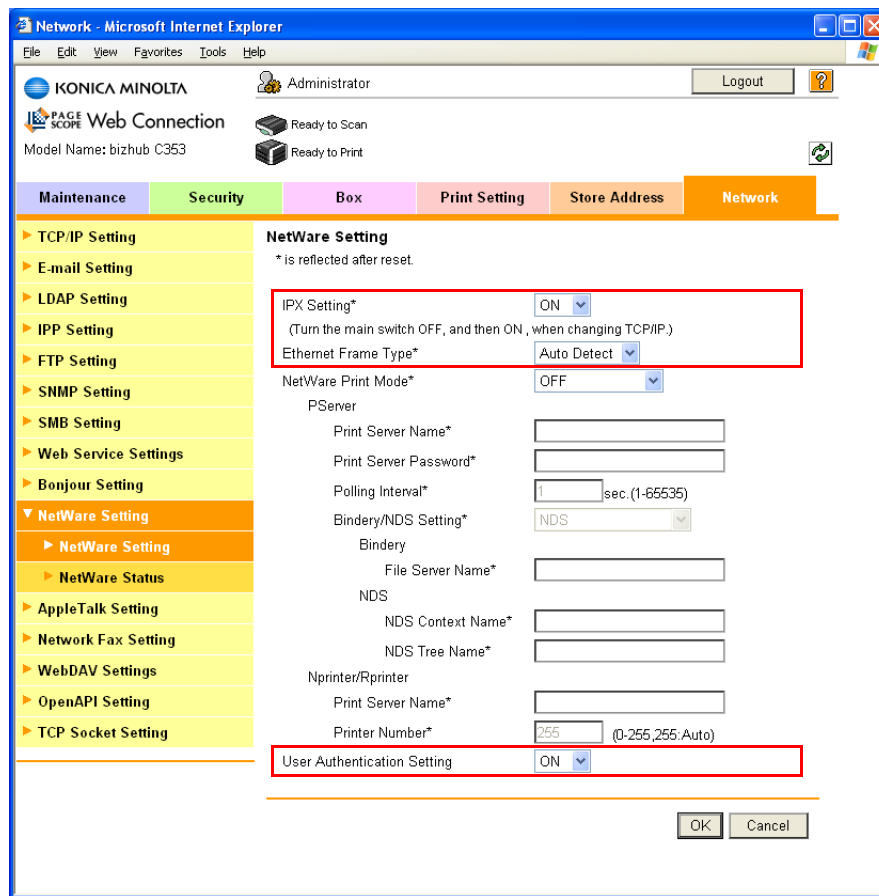

Item	Definition	Prior confirmation
IPX Setting	Select "ON".	
Ethernet Frame Type	Specify the frame type to be used.	Frame type
User Authentication Setting	Select "ON".	

## 1.38 Limiting users using this machine (LDAP)

Specify settings for limiting users of this machine using the LDAP server.

To perform authentication using the LDAP server, use this setting. This setting limits functions available on a user basis.

Specify the settings according to the following flowchart.

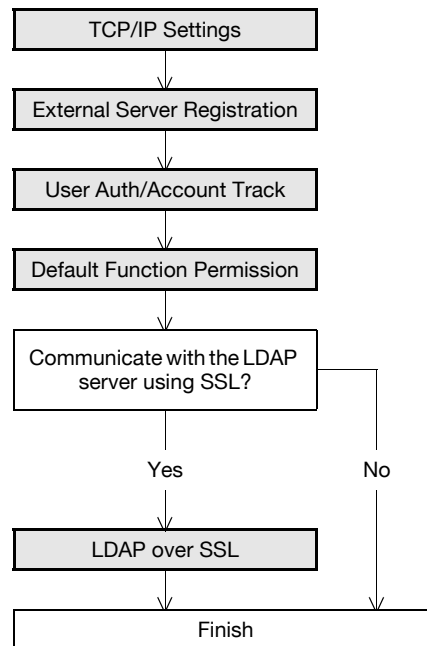

### 1.38.1 TCP/IP Settings

Specify settings to use this machine in a TCP/IP network environment.

For details, refer to ["Specifying general settings for TCP/IP-based communication"](#) on page 1-2.

### 1.38.2 External Server Registration

In Administrator mode of PageScope Web Connection, select the Security tab - "Authentication" - "External Server Registration" - [Edit].

Specify the following settings.

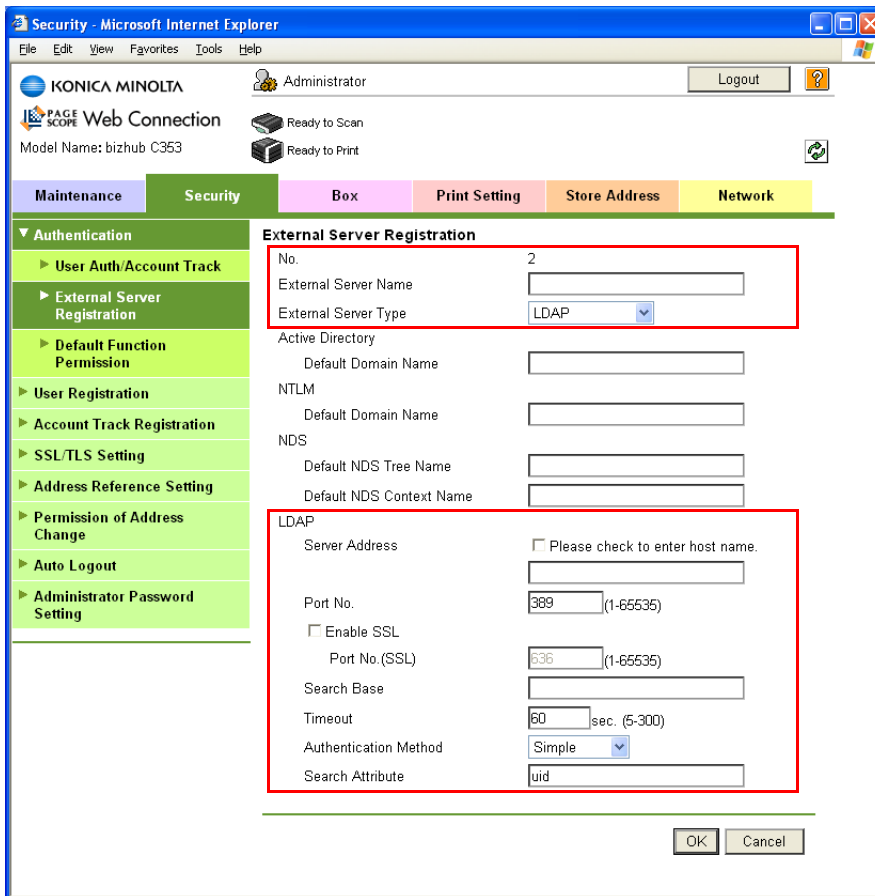

Item	Definition	Prior confirmation
No.	Displays the registration number.	
External Server Name	Enter the name of the external authentication server (up to 32 characters).	
External Server Type	Select "LDAP".	
Server Address	Specify the LDAP server address. (Format: "****.***.***.***", Range for ***: 0 to 255) If the DNS server is specified, the address can be specified using the host name. This item can also be specified with IPv6.	Address of the server
Port No.	Specify the port number.	Port number for the server
Search Base	Specify the search starting point in a hierarchical structure placed on the LDAP server. Searches are performed by also including the subdirectories lower than the starting point that was specified.	
Timeout	Specify the maximum wait time for a search operation.	
Authentication Method	Select the authentication method used for logging in to the LDAP server.	Authentication method for the server
Search Attribute	If "Digest-MD5" is selected as the authentication method, specify the search attribute.	

### 1.38.3 User Auth/Account Track

In Administrator mode of PageScope Web Connection, select the Security tab - "Authentication" - "User Auth/Account Track".

Specify the following setting.



#### Detail

*If authentication is performed with PageScope Authentication Manager, this menu item does not appear.*

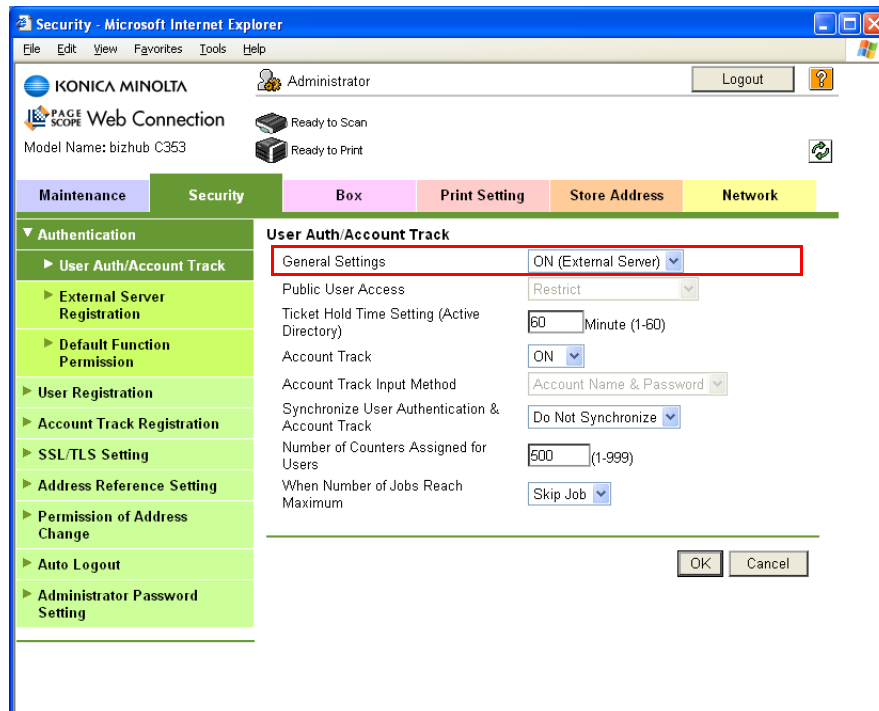

Item	Definition	Prior confirmation
General Settings	Select "ON (External Server)".	

### 1.38.4 Default Function Permission

Limits functions available to authorized users on this machine.

For details, refer to "[Default Function Permission](#)" on page 1-105.

## 1.38.5 LDAP over SSL

### External Server Registration

In Administrator mode of PageScope Web Connection, select the Security tab - "Authentication" - "External Server Registration" - [Edit].

Specify the following settings.

Item	Definition	Prior confirmation
Enable SSL	To encrypt communication between this machine and the LDAP server using SSL, select the "Enable SSL" check box.	Whether the sever supports SSL
Port Number (SSL)	Specify the port number used in SSL communication.	Port number for the server

### Action for Invalid Certificate

In Administrator mode of PageScope Web Connection, select the Security tab - "SSL/TLS Setting" - "Action for Invalid Certificate".

Specify the following setting.

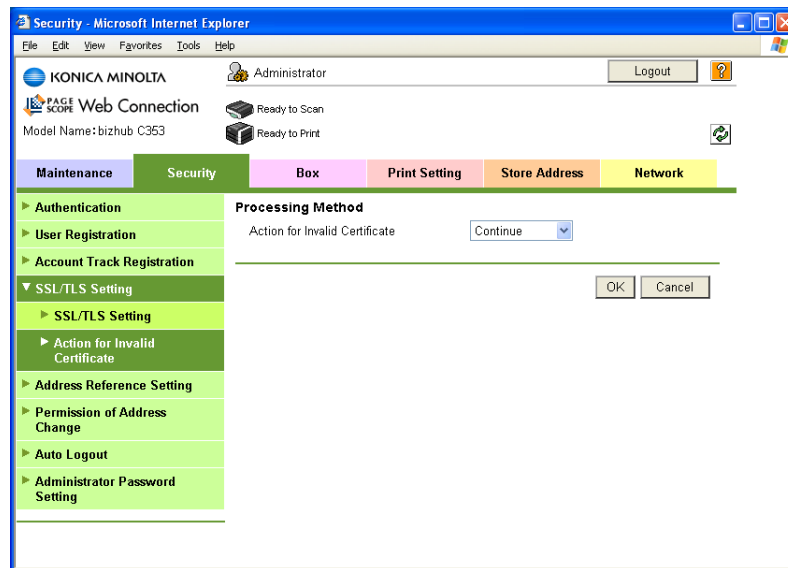

Item	Definition	Prior confirmation
Action for Invalid Certificate	Specify the operation when the validity period for the received certificate has expired. If "Continue" is selected, processing continues even if the date of the certificate is invalid. If "Delete the Job" is selected, the job is deleted if the date of the certificate is invalid.	

### 1.39 Performing IP address filtering

Specify settings for performing IP address filtering.

Performing IP address filtering limits access from specified IP addresses. Specify addresses from which this machine is accessible and inaccessible.

Specify the settings according to the following flowchart.

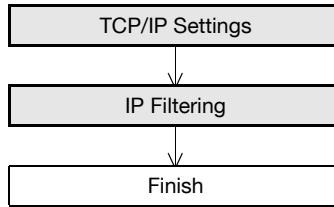

#### 1.39.1 TCP/IP Settings

Specify settings to use this machine in a TCP/IP network environment.

For details, refer to "[Specifying general settings for TCP/IP-based communication](#)" on page 1-2.

#### 1.39.2 IP Filtering

In Administrator mode of PageScope Web Connection, select the Network tab - "TCP/IP Setting" - "IP Filtering".

Specify the following settings.

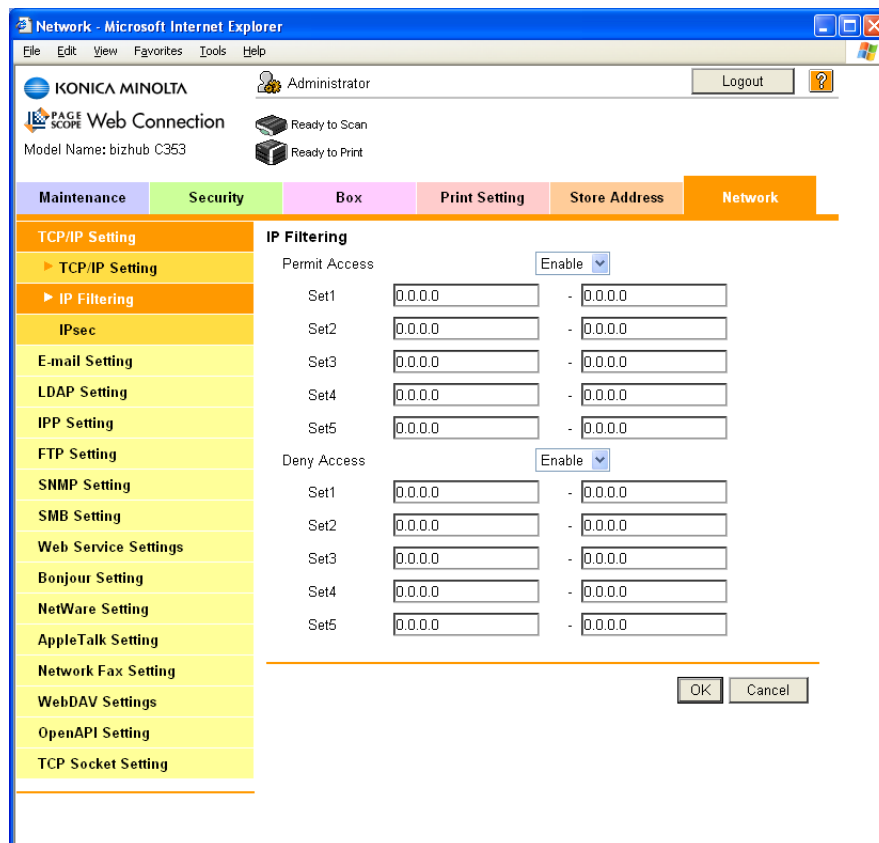

Item	Definition	Prior confirmation
Permit Access	To specify permitted addresses, select "Enable".	
Set 1 to 5	Specify permitted addresses. (Format: "****.***.***.***", Range for ***: 0 to 255)	Permitted addresses
Deny Access	To specify denied addresses, select "Enable".	
Set 1 to 5	Specify denied addresses. (Format: "****.***.***.***", Range for ***: 0 to 255)	Denied addresses

## 1.40 Communicating using IPv6

Specifying settings for IPv6-based communication

To allocate the IPv6 address to this machine, use this setting. IPv6 can run simultaneously with IPv4. However, IPv6 does not run independently.

When using this machine under the IPv6 environment, there are the following restrictions.

- Printing using SMB is not available (available for direct hosting service).
- Sending scan data using SMB is not available (available for direct hosting service).
- SMB browsing is not available.
- NTLM authentication is not available (available for direct hosting service).
- PageScope NDPS Gateway cannot be used.
- DHCPv6 cannot be used.
- IP filtering is not available.
- The printer driver installer cannot be used.
- PageScope Web Connection cannot be displayed with Flash.



### Detail

*For details on the direct hosting service, refer to the following sections.*

*["Sending scan data to a Windows computer" on page 1-19](#)*

*["Printing \(SMB\)" on page 1-62](#)*

*["Limiting users using this machine \(Windows domain/workgroup\)" on page 1-106](#)*

## TCP/IP Setting

In Administrator mode of PageScope Web Connection, select the Network tab - "TCP/IP Setting" - "TCP/IP Setting".

Specify the following settings.

Network - Microsoft Internet Explorer

KONICA MINOLTA Administrator Logout

PAGE SCOPE Web Connection Ready to Scan Ready to Print  
Model Name: bizhub C353

Maintenance Security Box Print Setting Store Address **Network**

**TCP/IP Setting**

TCP/IP Setting  
\* is reflected after reset.

TCP/IP\* ON

(Turn the main switch OFF, and then ON, when changing TCP/IP.)

Network Speed Auto

IP Address Setting Method\* Auto Setting

DHCP\*  
 BootP\*  
 ARP/PING\*  
 AutoIP\*

IP Address 0.0.0.0  
Subnet Mask 0.0.0.0  
Default Gateway 0.0.0.0

IPv6 ON

Auto IPv6 Setting\* ON

Link-Local Address  
Global Address  
Prefix Length  
Gateway Address

RAW Port Number

Port 1 9100 (1-65535)  
 Port 2 9112 (1-65535)  
 Port 3 9113 (1-65535)  
 Port 4 9114 (1-65535)  
 Port 5 9115 (1-65535)  
 Port 6 9116 (1-65535)

Dynamic DNS Setting Disable

Host Name thames

DNS Domain Name Setting

DNS Domain Auto Obtain Enable

DNS Default Domain Name  
DNS Search Domain Name1  
DNS Search Domain Name2  
DNS Search Domain Name3

DNS Server Setting

DNS Server Auto Obtain Enable

Primary DNS Server 0.0.0.0  
Secondary DNS Server1 0.0.0.0  
Secondary DNS Server2 0.0.0.0

**SLP Setting**

SLP Enable

**LPD Setting**

LPD Enable

OK Cancel



Item	Definition	Prior confirmation
TCP/IP	Select "ON".	
IPv6	Select "ON".	
Auto IPv6 Setting	To automatically obtain the IPv6 address, select "ON".	Whether to automatically obtain the IPv6 address
Link-Local Address	Displays the link-local address generated from the MAC address.	
Global Address	When not automatically obtain the IPv6 address, specify the IPv6 global address.	IPv6 address
Prefix Length	When not automatically obtain the IPv6 address, specify the IPv6 global address prefix length.	Prefix length
Gateway Address	When not automatically obtain the IPv6 address, specify the IPv6 gateway address.	Gateway address

**Detail**

*If necessary, specify settings for DNS. For details, refer to ["Specifying general settings for TCP/IP-based communication"](#) on page 1-2.*

## 1.41 Communicating using IPsec

Specify settings for IPsec-based communication

Communicating using IPsec prevents falsification and disclosure of data by IP packet. This function ensure safer communication even if transport or application that does not support encryption is used

Specify the settings according to the following flowchart.

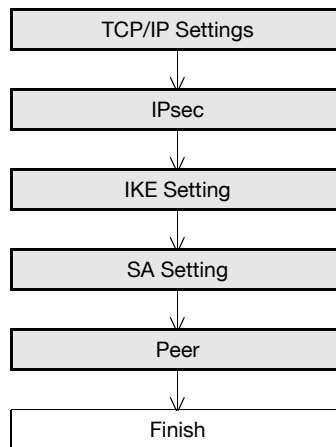

### 1.41.1 TCP/IP Settings

Specify settings to use this machine in a TCP/IP network environment.

For details, refer to "[Specifying general settings for TCP/IP-based communication](#)" on page 1-2.

### 1.41.2 IPsec

In Administrator mode of PageScope Web Connection, select the Network tab - "TCP/IP Setting" - "IPsec".  
Specify the following setting.

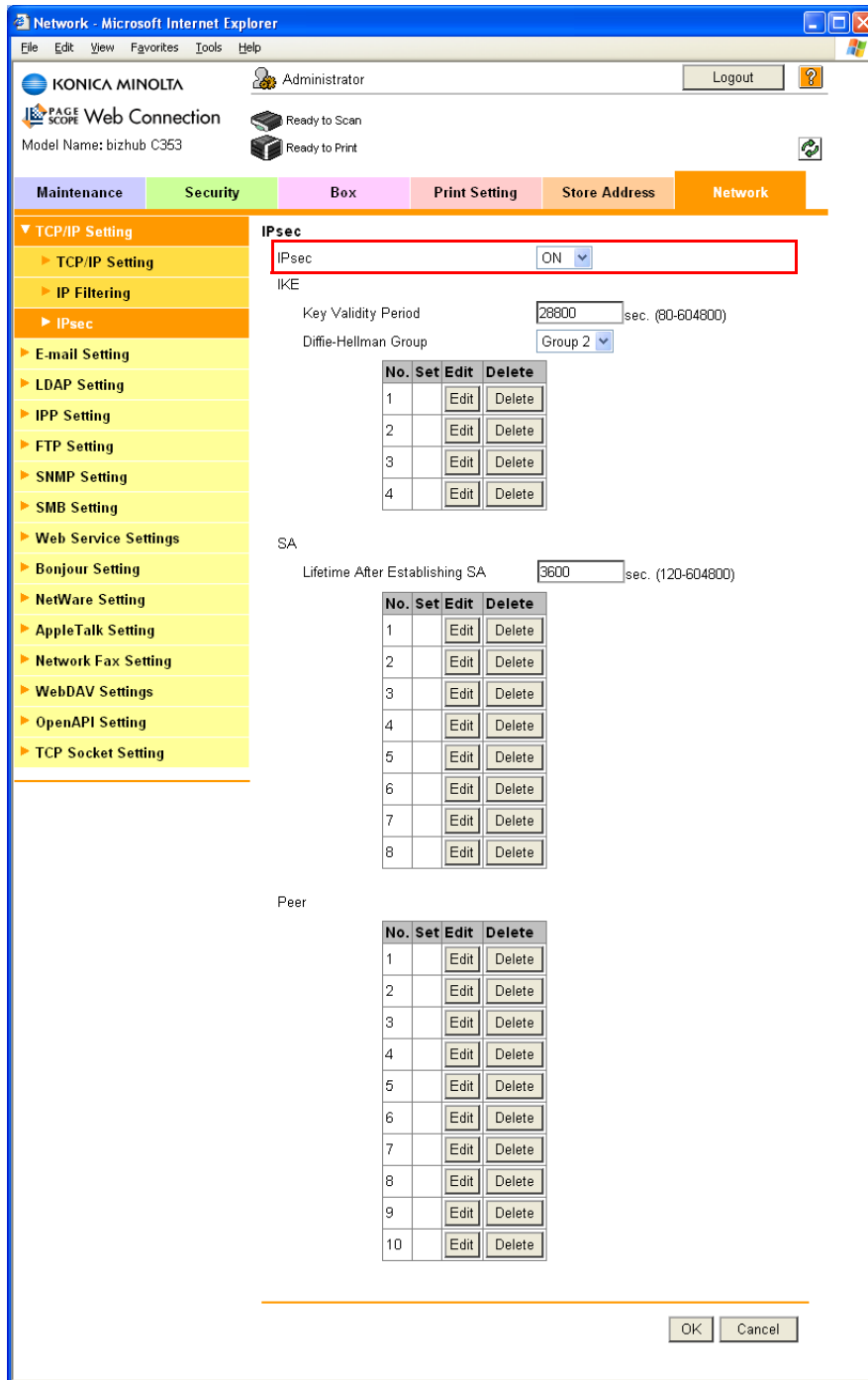

Item	Definition	Prior confirmation
IPsec	Select "ON".	

### 1.41.3 IKE Setting

In Administrator mode of PageScope Web Connection, select the Network tab - "TCP/IP Setting" - "IPsec" - "IKE" - [Edit].

Specify the following settings. (Up to four groups can be registered in "IKE".)

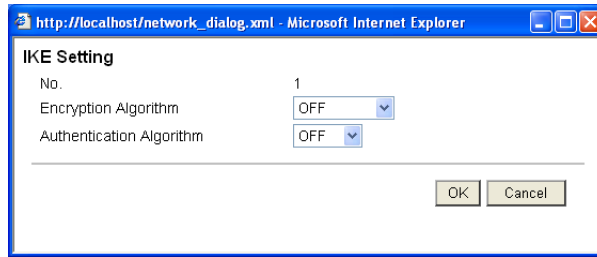

Item	Definition	Prior confirmation
Key Validity Period	Specify the validity period of a key generated when creating a control tunnel.	
Diffie-Hellman Group	Select "Diffie-Hellman Group".	
Encryption Algorithm	Select the encryption algorithm to be used when creating a control tunnel.	
Authentication Algorithm	Select the authentication algorithm to be used when creating a control tunnel.	

### 1.41.4 SA Setting

In Administrator mode of PageScope Web Connection, select the Network tab - "TCP/IP Setting" - "IPsec" - "SA" - [Edit].

Specify the following settings. (Up to eight groups can be registered in "SA".)

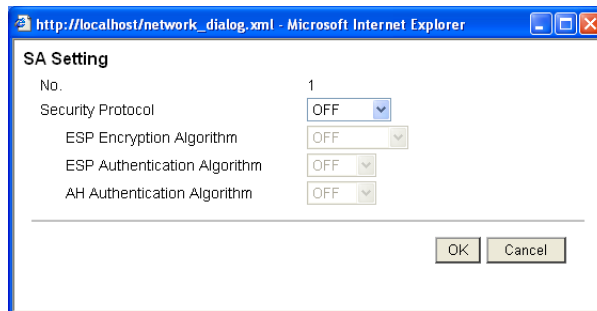

Item	Definition	Prior confirmation
Lifetime After Establishing SA	Specify the validity period of a key generated when creating a communication tunnel.	
Security Protocol	Select the security protocol.	
ESP Encryption Algorithm	When "ESP" is selected for "Security Protocol", specify the ESP encryption algorithm.	
ESP Authentication Algorithm	When "ESP" is selected for "Security Protocol", specify the ESP authentication algorithm.	
AH Authentication Algorithm	When "AH" is selected for "Security Protocol", specify the AH authentication algorithm.	

### 1.41.5 Peer

In Administrator mode of PageScope Web Connection, select the Network tab - "TCP/IP Setting" - "IPsec" - "Peer" - [Edit].

Specify the following settings. (Up to 10 peers can be registered in "Peer".)

Item	Definition	Prior confirmation
Perfect Forward Secrecy	To increase the IKE strength, select "ON".	
Peer	Specify the IP address of the peer.	IP address of the peer
Pre-Shared Key Text	Specify the Pre-Shared Key text shared with the peer.	
Encapsulation Mode	Specify the operation mode of IPsec.	

## 1.42 Using the TCP Socket/OpenAPI function

Specify settings for TCP Socket, and OpenAPI of this machine.

TCP socket is used during data transmissions between the computer application and this machine.

To synchronize this machine with a different OpenAPI-based system, specify settings for OpenAPI.

If authentication is performed with PageScope Authentication Manager, specify the SSL/TLS settings, and then enable the SSL/TLS settings of the TCP Socket and OpenAPI settings.

Specify the settings according to the following flowchart.

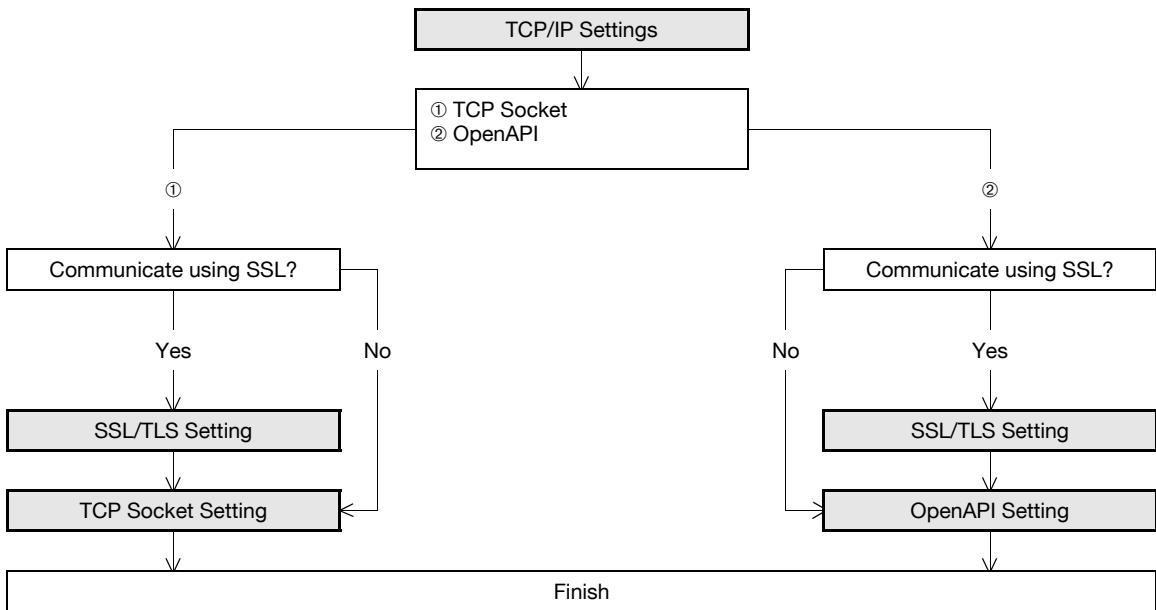

### 1.42.1 TCP/IP Settings

Specify settings to use this machine in a TCP/IP network environment.

For details, refer to ["Specifying general settings for TCP/IP-based communication" on page 1-2.](#)

### 1.42.2 SSL/TLS Setting

Specify settings for SSL-based communication.

For details, refer to ["Creating a certificate for this machine for SSL-based communication" on page 1-7.](#)

### 1.42.3 TCP Socket Setting

In Administrator mode of PageScope Web Connection, select the Network tab - "TCP Socket Setting".  
Specify the following settings.



#### Detail

To use SSL/TLS, install the certificate in advance. For details, refer to "[Creating a certificate for this machine for SSL-based communication](#)" on page 1-7.

The screenshot shows the 'Network' tab in the PageScope Web Connection interface. The 'TCP Socket Setting' section is expanded and highlighted with a red box. The settings are as follows:

- TCP Socket (Turn the main switch OFF, and then ON, when changing TCP Socket)
- Port Number: 59158 (1-65535)
- Use SSL/TLS
- Port No. (SSL): 59159 (1-65535)
- TCP Socket(ASCII Mode)
- Port No. (ASCII Mode): 59160 (1-65535)

Buttons for 'OK' and 'Cancel' are visible at the bottom right of the settings area.

Item	Definition	Prior confirmation
TCP Socket	Select the "TCP Socket" check box.	
Port Number	Specify the port number.	
Use SSL/TLS	To use SSL/TLS, select the "Use SSL/TLS" check box.	Whether to use SSL/TLS
Port No. (SSL)	Specify the port number used in SSL communication.	



#### Detail

If Enhanced Security Mode is set to "ON", the "Use SSL/TLS" check box is selected.

## 1.42.4 OpenAPI Setting

In Administrator mode of PageScope Web Connection, select the Network tab - "OpenAPI Setting".  
Specify the following settings.



### Detail

To use SSL/TLS, install the certificate in advance. For details, refer to "[Creating a certificate for this machine for SSL-based communication](#)" on page 1-7.

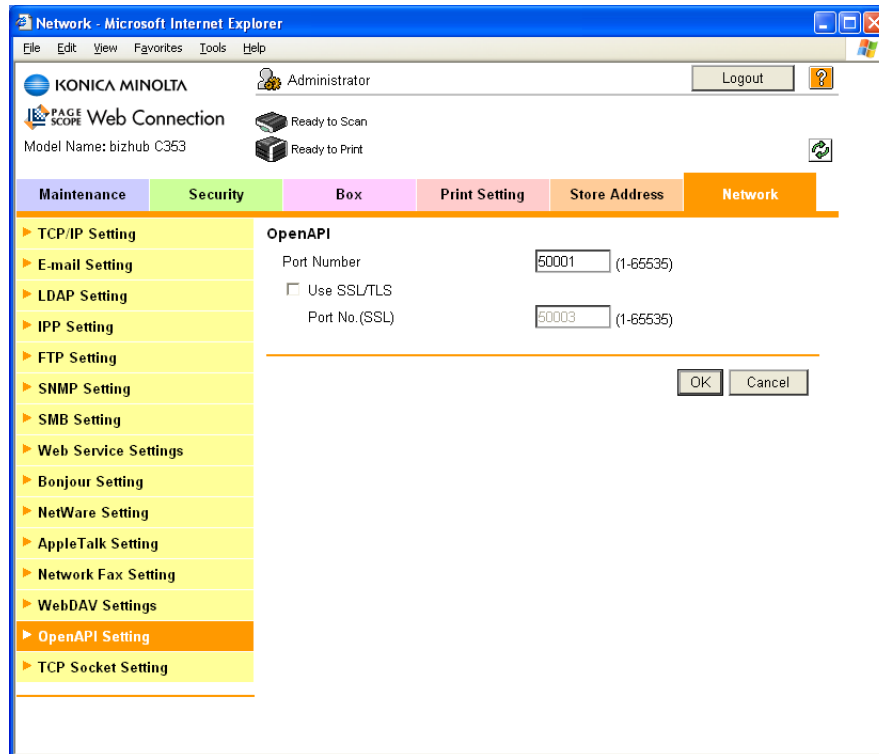

Item	Definition	Prior confirmation
Port Number	Specify the port number.	
Use SSL/TLS	To use SSL/TLS, select the "Use SSL/TLS" check box.	Whether to use SSL/TLS
Port No. (SSL/TLS)	Specify the port number used in SSL communication.	



### Detail

If Enhanced Security Mode is set to "ON", the "Use SSL/TLS" check box is selected.

If authentication is performed with PageScope Authentication Manager from the printer driver, set "Authentication" for OpenAPI Settings to "OFF" from the control panel.



## 1.43 Using FTP server/WebDAV server functions

Specify settings for FTP server and WebDAV server of this machine.

This machine serves as an FTP server or WebDAV server by specifying the following settings. To use an application that synchronizes with this machine as an FTP or WebDAV client, specify these settings.

By using this machine as a WebDAV server, communication with application software can be encrypted using SSL and safer communication is enabled.

Specify the settings according to the following flowchart.

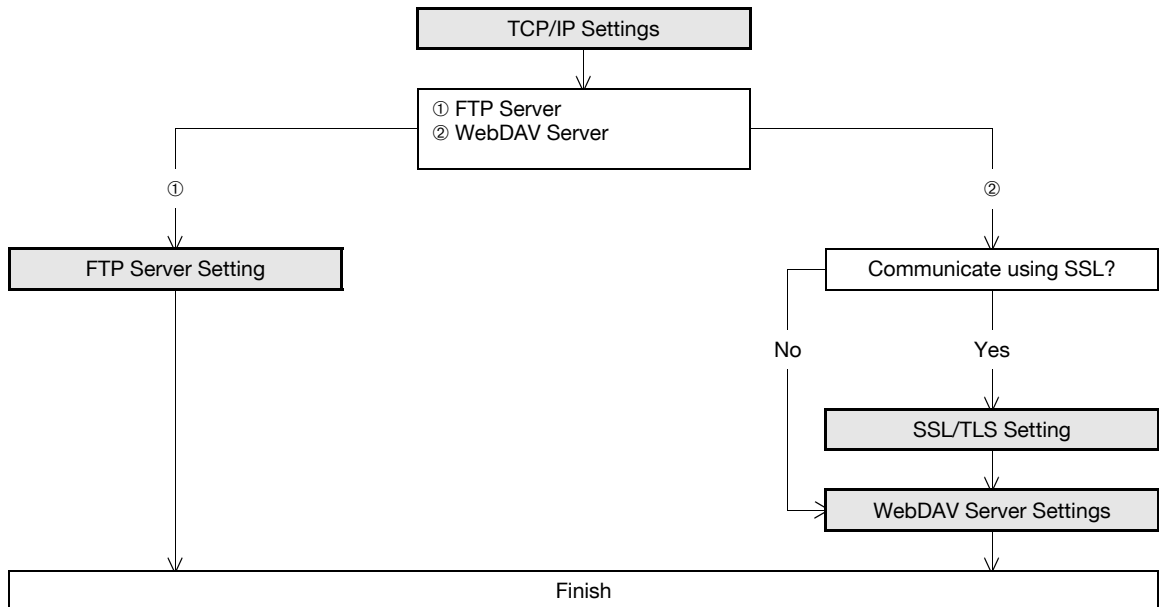

### 1.43.1 TCP/IP Settings

Specify settings to use this machine in a TCP/IP network environment.

For details, refer to ["Specifying general settings for TCP/IP-based communication" on page 1-2](#).

### 1.43.2 SSL/TLS Setting

Specify settings for SSL-based communication.

For details, refer to ["Creating a certificate for this machine for SSL-based communication" on page 1-7](#).

### 1.43.3 FTP Server Setting

In Administrator mode of PageScope Web Connection, select the Network tab - "FTP Setting" - "FTP Server Setting".

Specify the following settings.

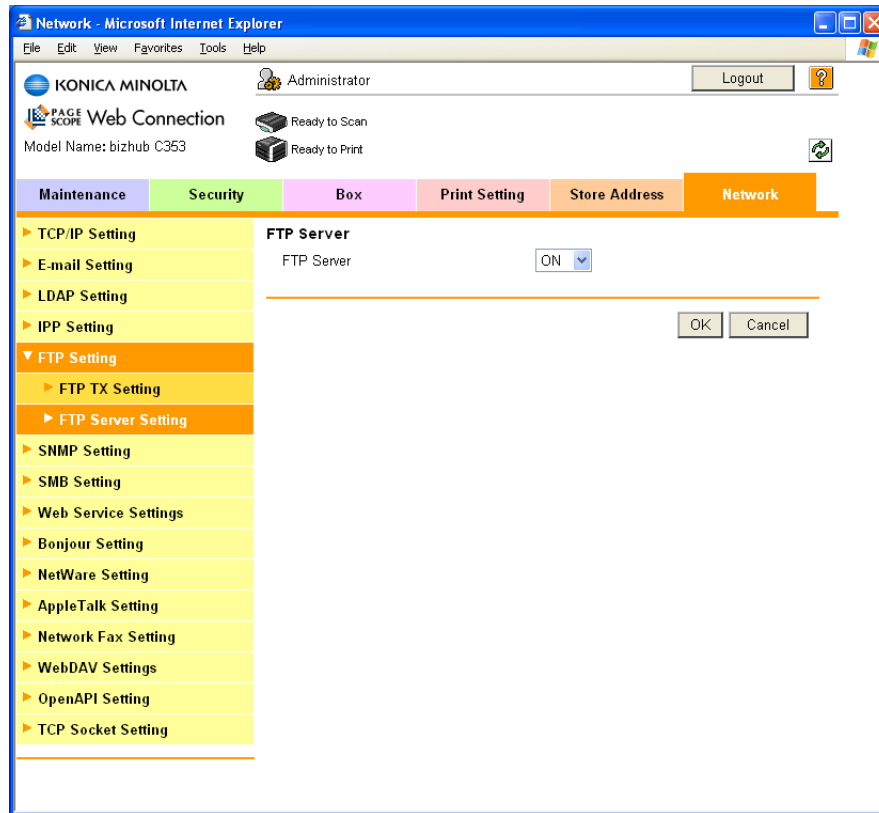

Item	Description	Prior confirmation
FTP Server	Select "ON".	



#### Detail

*If Enhanced Security Mode is set to enable, "OFF" is selected.*

### 1.43.4 WebDAV Server Settings

In Administrator mode of PageScope Web Connection, select the Network tab - "WebDAV Settings" - "WebDAV Server Settings".

Specify the following settings.



**Detail**

To use SSL/TLS, install the certificate in advance. For details, refer to "Creating a certificate for this machine for SSL-based communication" on page 1-7.

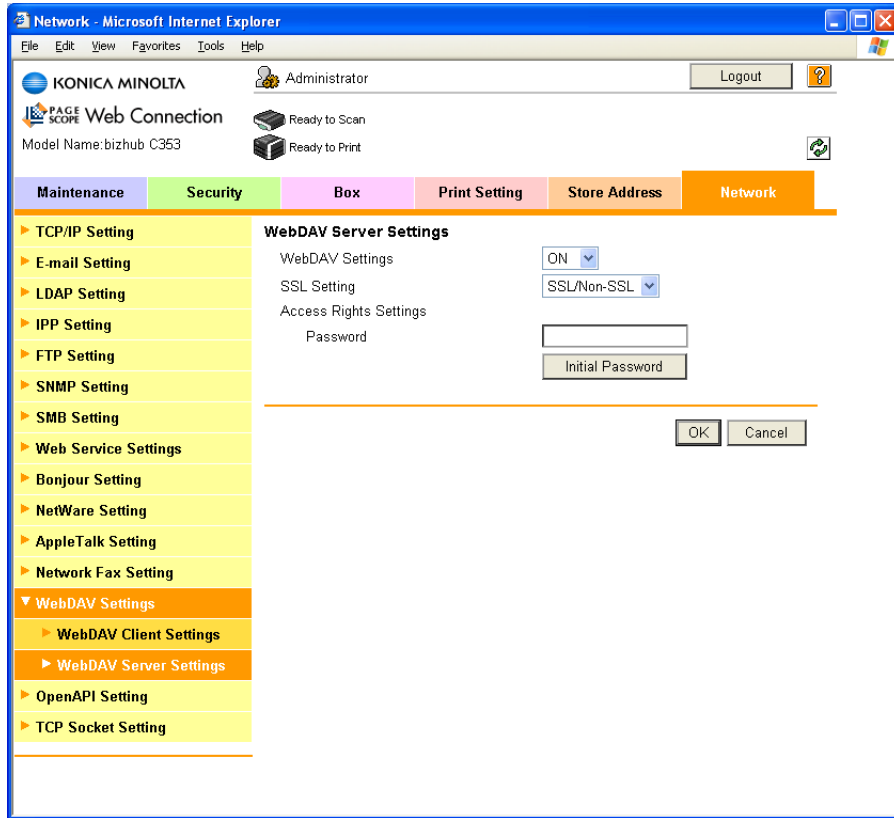

Item	Description	Prior confirmation
WebDAV Settings	Select "ON".	
SSL Setting	To use SSL/TLS, select "SSL Only" or "SSL/Non-SSL".	Use SSL/TLS?
Password	Specify the password for connecting to the WebDAV server.	
[Initial Password]	The specified password can be initialized. Default: sysadm	

## 1.44 Other items on the Maintenance tab

This section describes other items specifiable on the Maintenance tab for the PageScope Web Connection.

### 1.44.1 Using external memory

Specify settings for using external memory on this machine.

To use an external memory, this machine must be equipped with an optional local interface kit.

Connecting external memory to this machine allows sending scanned data to external memory and printing data in external memory.



#### Reminder

*The optional local interface kit is equipped with two USB connectors. As one is for optional connection, two sets of external memories cannot be connected at a time.*

*Do not pull out the external memory while a document is being saved to the external memory or being printed.*

#### External Memory Function Settings

In Administrator mode of PageScope Web Connection, select the Maintenance tab - "External Memory Function Settings".

Specify the following settings.

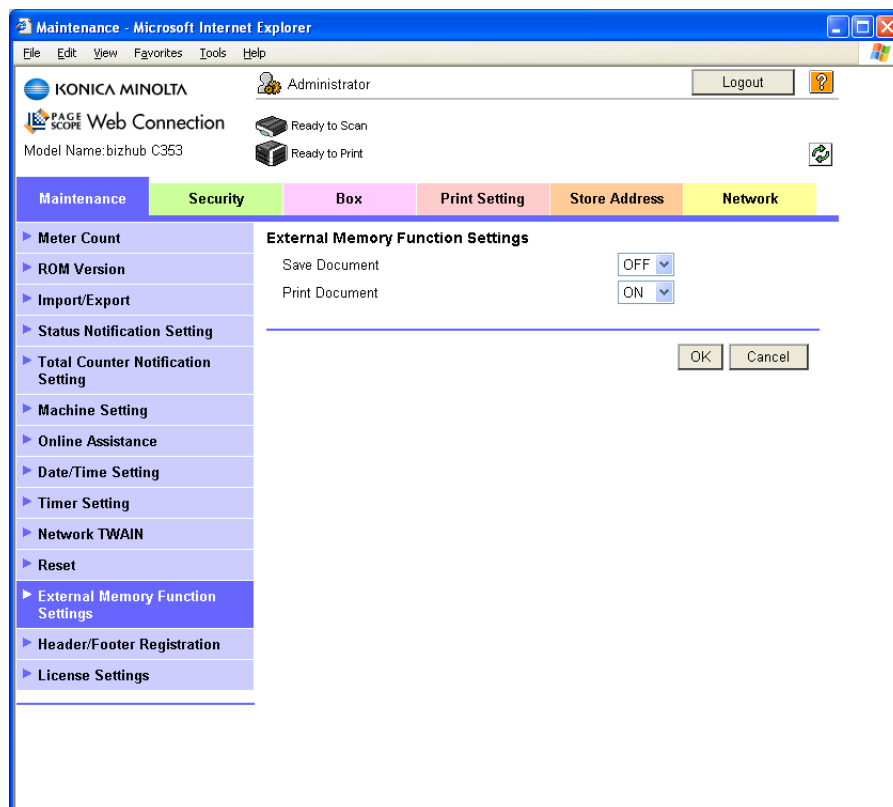

Item	Definition
Save Document	To send scanned data to external memory, select "ON". To prevent data from being stolen, "OFF" is specified as default. To use an external memory, select "ON".
Print Document	To print data in external memory, select "ON".

## 1.44.2 Using the timer function

Specify settings for the timer function of this machine.

Settings for the power save function and weekly timer function can be specified.

### Power Save Setting

In Administrator mode of PageScope Web Connection, select the Maintenance tab - "Timer Setting" - "Power Save Setting".

Specify the following settings.

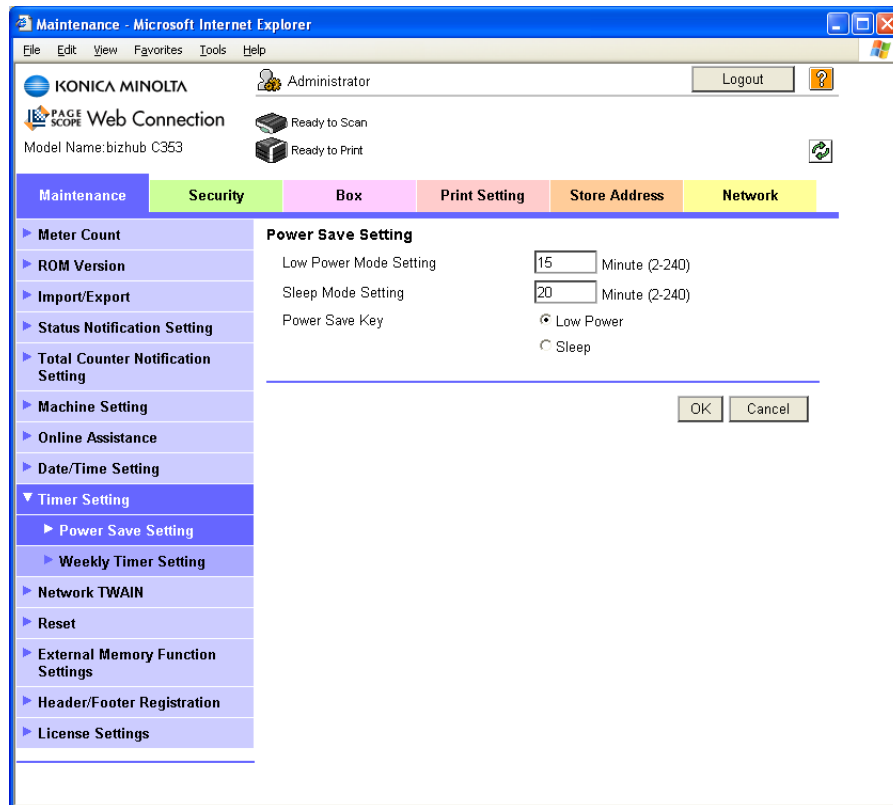

Item	Definition
Low Power Mode Setting	Specify the time period before the machine enters Low Power mode.
Sleep Mode Setting	Specify the time period before the machine enters Sleep mode.
Power Save Key	Manually specify the setting for the power save function (Low Power or Sleep mode).

## Weekly Timer Setting

In Administrator mode of PageScope Web Connection, select the Maintenance tab - "Timer Setting" - "Weekly Timer Setting".

Specify the following settings.

Item	Definition
Use Weekly Timer	To use the weekly timer function, select this check box, and then specify the operating date and time. To display the screen for specifying dates, click [Setting]. Weekly setting and daily settings are possible.
Use Power Save	To use the power save function, select this check box, and then specify the starting and ending times for power saving
Use Overtime Password	To use the non-business hours password function, select this check box, and then specify the password.

### 1.44.3 Importing or exporting setting information

Import or export setting information of this machine.

Machine settings can be saved (exported) from this machine to the computer, or can be written from the computer to the machine (imported).

#### Import/Export

In Administrator mode of PageScope Web Connection, select the Maintenance tab - "Import/Export".

Specify the following settings.

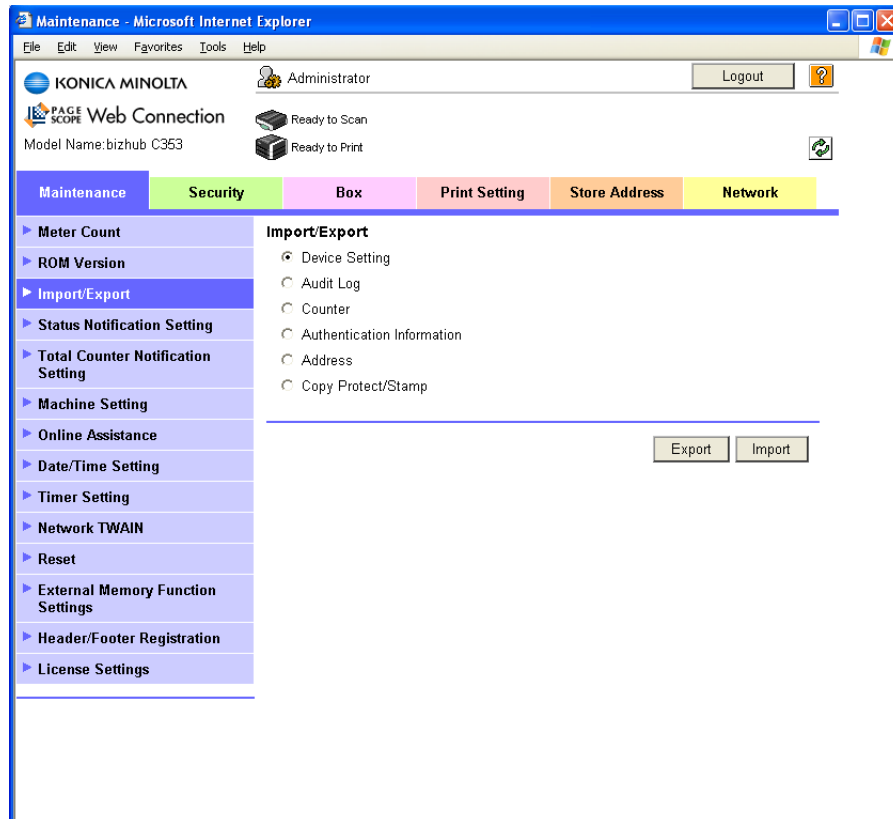

Item	Definition
Device Setting	Imports or exports device settings.
Audit Log	Exports the audit log information.
Counter	Exports the counter information.
Authentication Information	Backs up and restores the entire authentication data. Also, user registration information and authentication data can be imported or exported. When using an optional authentication unit on this machine, authentication data can be imported or exported. When exporting authentication information, a password can be specified if necessary. The specified password is required when importing the authentication information. If authentication is performed with PageScope Authentication Manager, this menu item does not appear.
Address	Backs up and restores the entire address data. Also, information on each address can be imported or exported. When exporting address information, a password can be specified if necessary. The specified password is required when importing the address information.
Copy Protect/Stamp	Copy protect /stamp data can be imported or exported.



### Detail

*Exported files cannot be edited.*

*When E-mail destinations with certificates are exported and imported, the certificate information must be registered again after importing.*

*"Audit Log" and "Counter" are available only for exporting.*

*When importing or exporting authentication data, operate user registration information in the same way. Operate the authentication data after operate the user authentication information.*

*"Audit Log" is available when audit log setting is enabled on this machine.*

## 1.44.4 Resetting setting information

Reset machine settings.

Network settings, controller settings, and remote address settings can be reset.

### Network Setting Clear

In Administrator mode of PageScope Web Connection, select the Maintenance tab - "Reset" - "Network Setting Clear".

To reset to the factory default network settings, click [Clear].



### Detail

*If Enhanced Security Mode is set to "ON", this menu item does not appear.*

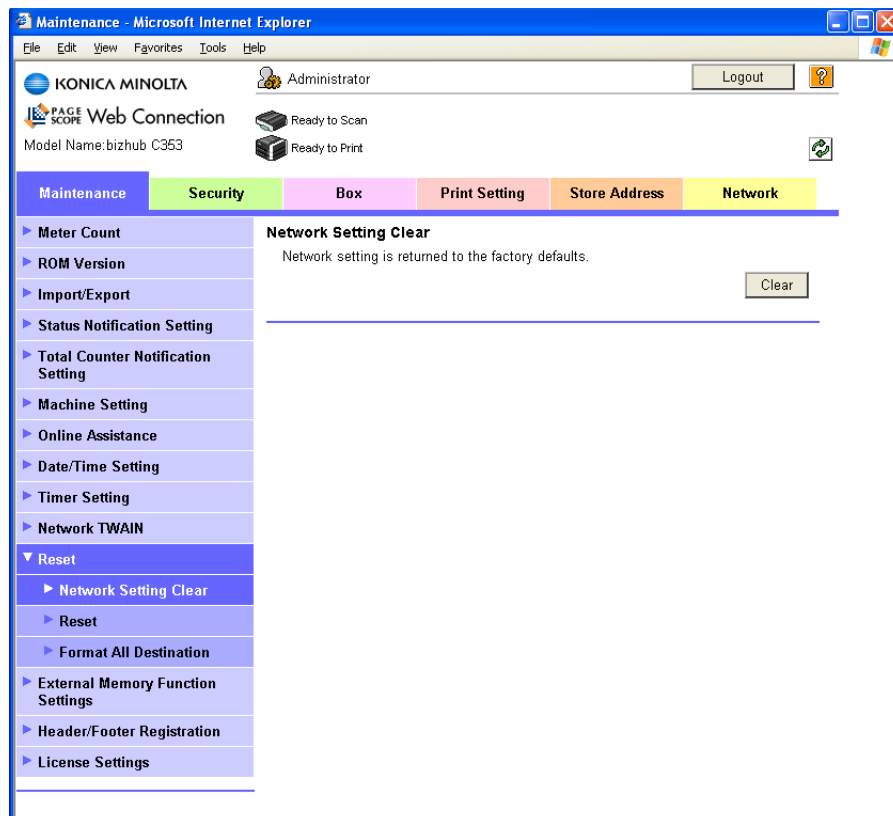



## Reset

In Administrator mode of PageScope Web Connection, select the Maintenance tab - "Reset" - "Reset".  
To reset the controller, click [Reset].

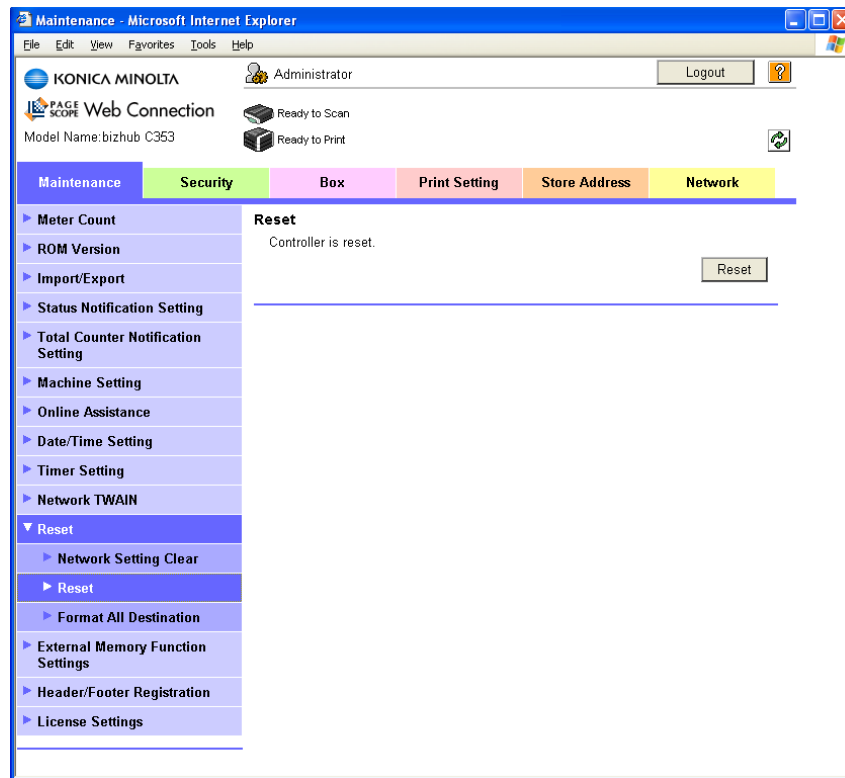

## Format All Destination

In Administrator mode of PageScope Web Connection, select the Maintenance tab - "Reset" - "Format All Destination".

To delete all destinations registered on the machine, click [Format].

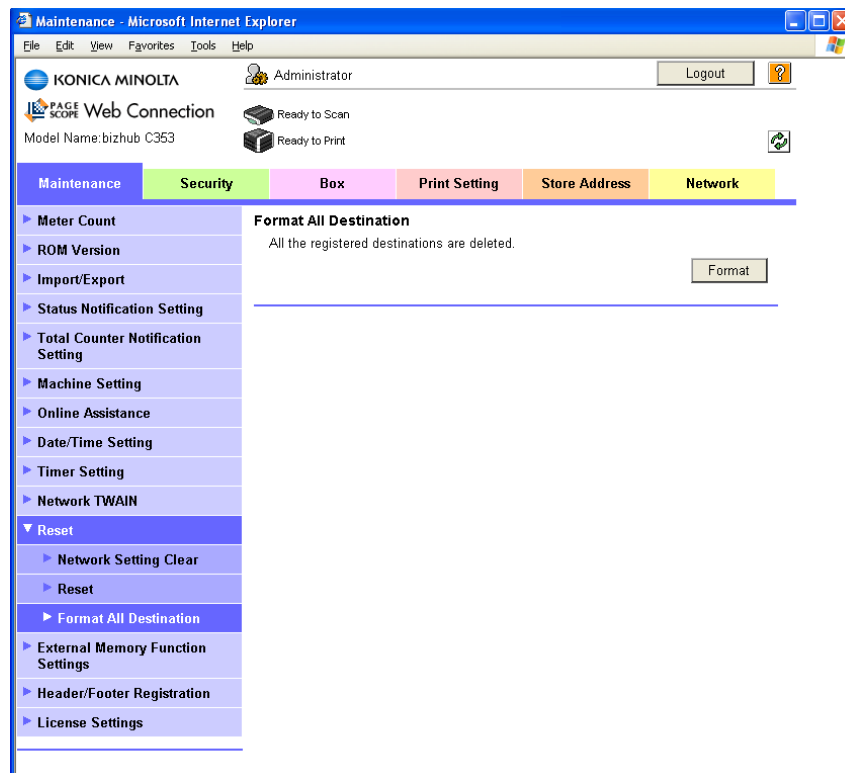

## 1.44.5 Specifying support information

Specify the support information for the machine.

### Online Assistance

In Administrator mode of PageScope Web Connection, select the Maintenance tab - "Online Assistance".

Specify the following settings.

The screenshot shows the 'Maintenance' tab selected in the 'PageScope Web Connection' interface. The 'Online Assistance' sub-tab is active, displaying a list of settings on the left and their corresponding input fields on the right. The 'Contact Name' field is filled with 'KONICA MINOLTA Customer Sup'. Other fields like 'Product Help URL' and 'Corporate URL' contain 'http://pagescope.com' and 'http://konicaminolta.com' respectively. The interface includes a 'Logout' button and a help icon in the top right corner.

Item	Definition
Contact Name	Specify the contact name for the machine (up to 63 characters).
Contact Information	Specify contact name information for the machine such as the phone number or URL (up to 127 characters).
Product Help URL	Specify the URL of the Web page for product information (up to 127 characters).
Corporate URL	Specify the URL of the Web page for corporate (up to 127 characters).
Supplies and Accessories	Specify consumables supplier information (up to 127 characters).
Online Help URL	Specify the online help URL (up to 127 characters).
Driver URL	Specify the driver storage location (up to 127 characters).

## 1.44.6 Registering the header or footer

To make copies on this machine, register a text that can be printed as a header or footer.

### Header/Footer Registration

In Administrator mode of PageScope Web Connection, select the Maintenance tab - "Header/Footer Registration" - [Edit].

Specify the following settings.

Item	Definition
No.	Displays the registration number.
Name	Specify the registration name.
Color	Specify the color.
Pages	Select the pages to be printed.
Size	Specify the size.
Date/Time Setting	Specify the date and time formats.
Distribution Number	Specify the distribution number text. Select the output format, and then specify the starting number.
Header/Footer	Specify whether to print the following items. <ul style="list-style-type: none"> <li>Header String/Footer String (up to 40 characters each)</li> <li>Date/Time Setting</li> <li>Distribution Number</li> <li>Job Number</li> <li>Serial Number</li> <li>User Name/Account Name</li> </ul>

## 1.44.7 Checking the ROM version

Check the ROM version of this machine.

### ROM Version

In Administrator mode of PageScope Web Connection, select the Maintenance tab - ROM Version.

Check the ROM version of this machine.

The screenshot shows the 'Maintenance' tab selected in the PageScope Web Connection interface. The 'ROM Version' section is expanded, displaying a list of components and their corresponding ROM versions. The interface includes a navigation menu on the left and a main content area on the right.

Component	ROM Version
MFP Controller BOOT Program	
MFP Controller SubSet Program	
MFP Controller	A02074-000-000-0001
Operation PANEL Message Data	A02084-000-000-0001
FAX Board Controller1	
FAX Board Controller2	
IR	00000000
PRT	00000000
ADF	
Finisher	A02081-000-000-0001
Panel Micro-Computer	A02081-000-000-0001
LCT	00000000
Loadable Device Driver	
System Controller	A02074-000-000-0001
Printer Controller	
Printer Controller-Font	
Printer Controller-Demo Page	A02074-000-000-0001
MIO	A02081-000-000-0001
PSWC	A02081-000-000-0001
MIB IF	
IPP IF	
External Controller IF	
TCP/Socket	A02081-000-000-0001
Open API	A02081-000-000-0001
Operation PANEL	A02081-000-000-0001
CSRC	
PIC	A02081-000-000-0001

## 1.44.8 Extending functions of MFP

A request code can be issued and license can be installed.



### Detail

For details on acquiring a license code and installing the license, refer to the Quick Guide [Copy/Print/Fax/Scan/Box Operations].

### Get Request Code

In Administrator mode of PageScope Web Connection, select the Maintenance tab - "License Settings" - "Get Request Code".

Click the [OK] button, and the request code is issued.

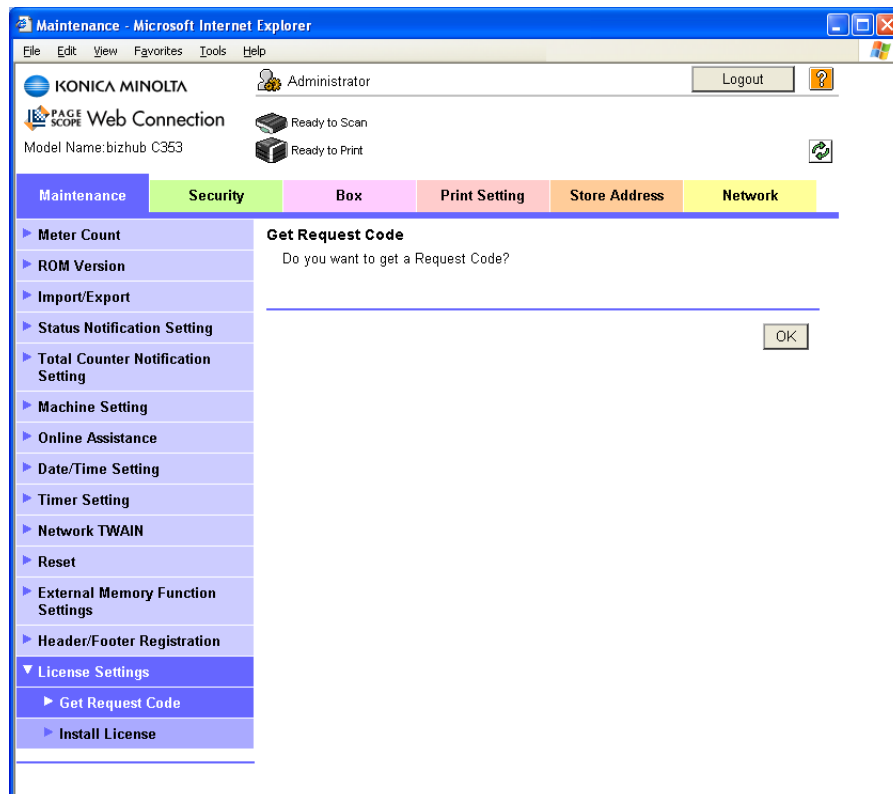

## Install License

In Administrator mode of PageScope Web Connection, select the Maintenance tab - "License Settings" - "Install License".

Specify the following settings.



### Detail

*If an additional memory included in optional upgrade kit is not installed, this menu item does not appear.*

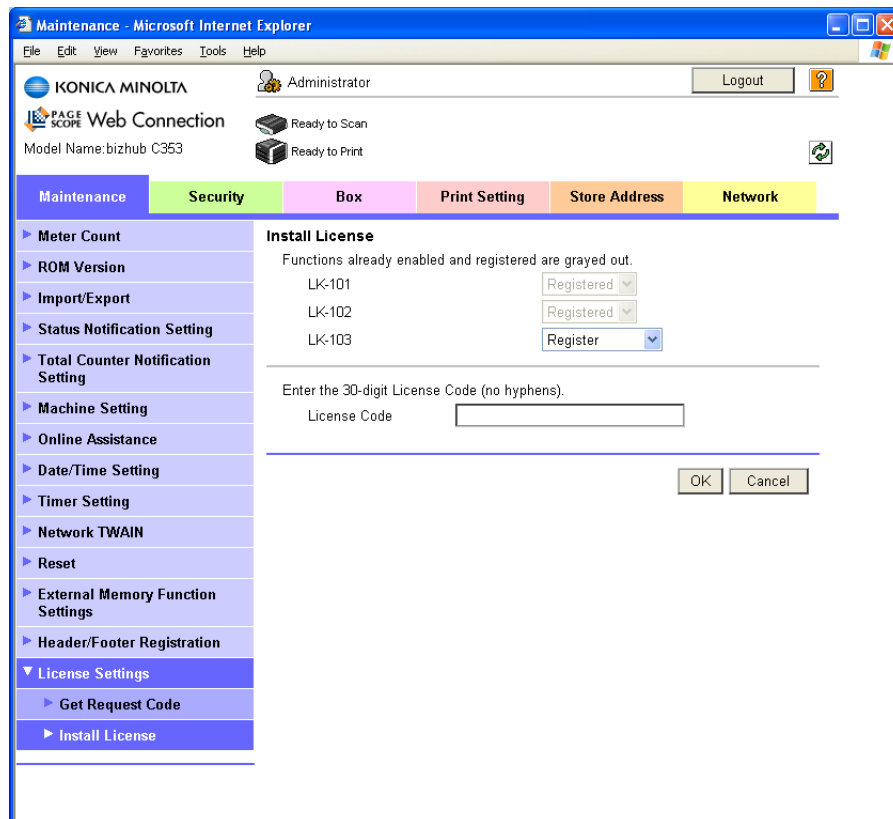

Item	Description
LK-101/102/103	Select a function to be enabled, and then select "Registered".
License Code	Enter the acquired license code without using hyphens.
[OK]	Enables the function.

## 1.45 Other items on the Security tab

This section describes other items specifiable on the Security tab for the PageScope Web Connection.

### 1.45.1 Limiting accessible destinations by user

Register reference allowed groups and specify whether to allow reference to public users.

Specifying the reference allowed group and the access allowed level for destinations to be registered limits destinations to be displayed on an accessing user basis at the time of user authentication or logging in to public mode.



#### Detail

For details on limiting access to destinations, refer to the User's Guide [Copy Operations].

When registering a user, specify groups accessible to the user and reference allowed level. For details, refer to ["User Registration" on page 1-98](#).

Specify the group that is allowed to access a destination to be registered when registering an address book destination and reference allowed level. For details, refer to ["Registering or editing an address book destination" on page 1-155](#).

#### Reference Allowed Group Registration

In Administrator mode of PageScope Web Connection, select the Security tab - "Address Reference Setting" - "Reference Allowed Group Registration" - [Edit].

Specify the following settings.

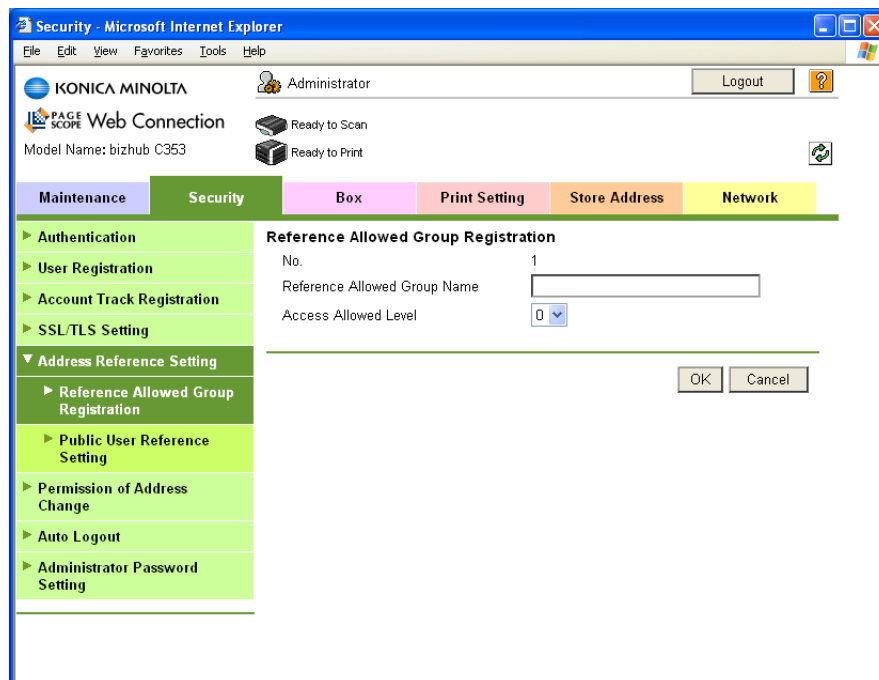

Item	Definition
No.	Displays the registration number.
Reference Allowed Group Name	Specify the reference allowed group name (up to 24 characters).
Access Allowed Level	Specify the access allowed level for the group.

## Public User Reference Setting

In Administrator mode of PageScope Web Connection, select the Security tab - "Address Reference Setting" - "Public User Reference Setting".

Specify the destination access right of public users. When "Reference Allowed Group" is selected, click [Search from List], and then select a reference allowed group from the list. When "Access Allowed Level" is selected, specify a level.

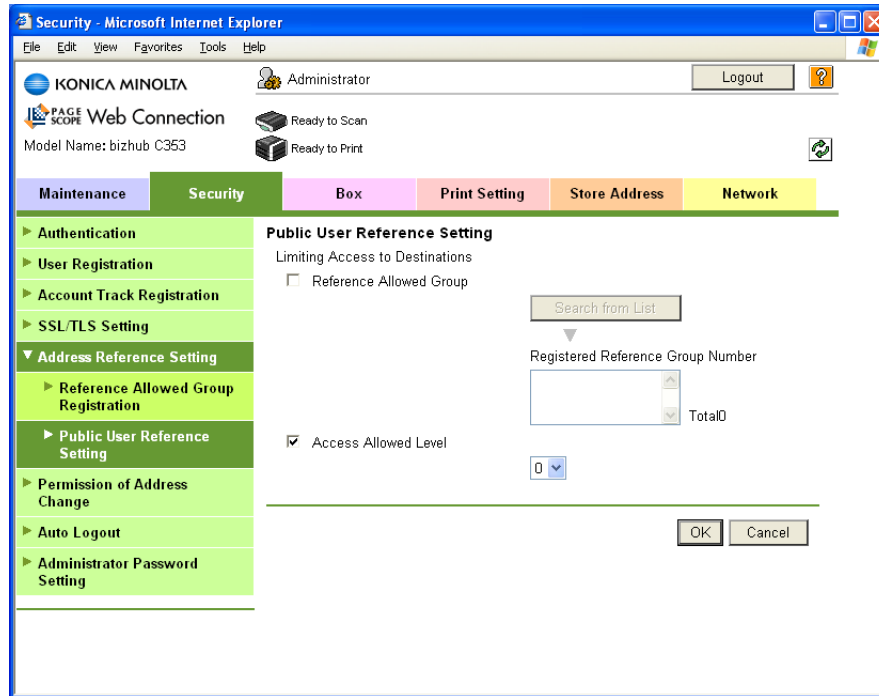

### 1.45.2 Restricting address registration by a user

Restrict address registration or change by a general user.

#### Permission of Address Change

In Administrator mode of PageScope Web Connection, select the Security tab - "Permission of Address Change".

Specify the following setting.

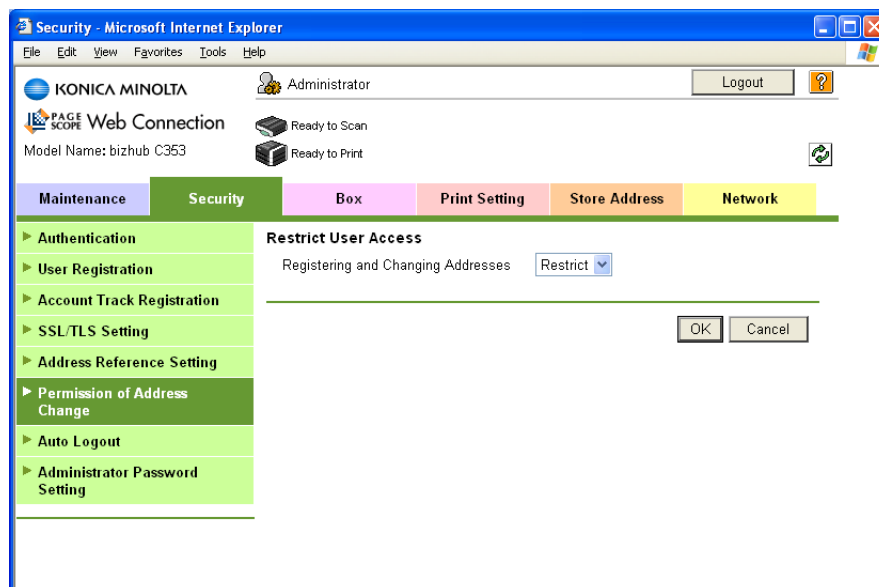



Item	Definition
Registering and Changing Addresses	Select "Restrict". If "Restrict" is selected, this menu item is not displayed on the Store Address tab in the user mode.



#### Detail

If Enhanced Security Mode is set to "ON", "Restrict" is specified.

### 1.45.3 Specifying the auto logout time

Specify the length of time before Administrator mode or User mode is automatically logged out.

If no operation is performed for the length of time specified here, the user will automatically be logged out.

#### Auto Logout

In Administrator mode of PageScope Web Connection, select the Security tab - "Auto Logout".

Specify the following settings.

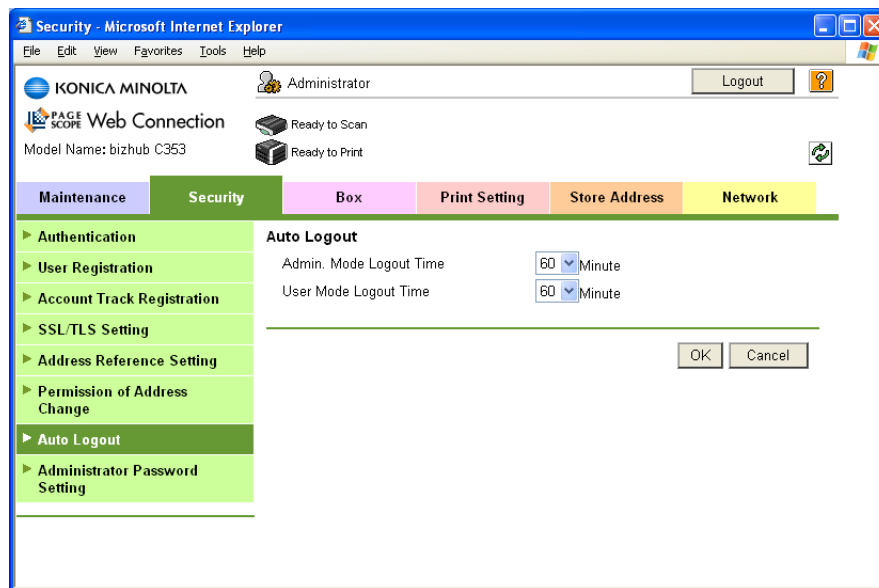

Item	Definition
Admin. Mode Logout Time	Specify the time period before the user is automatically logged out when no operation is performed for a certain period of time in Administrator mode.
User Mode Logout Time	Specify the time period before the user is automatically logged out when no operation is performed for a certain period of time in the user mode.

## 1.45.4 Specifying the administrator password

Specify the password for the machine's administrator.

### Administrator Password Setting

In Administrator mode of PageScope Web Connection, select the Security tab - "Administrator Password Setting".

Specify the following settings.



#### Detail

*If Enhanced Security Mode is set to "ON", this menu item does not appear.*

*If the certificate for this machine is not installed, this menu item does not appear.*

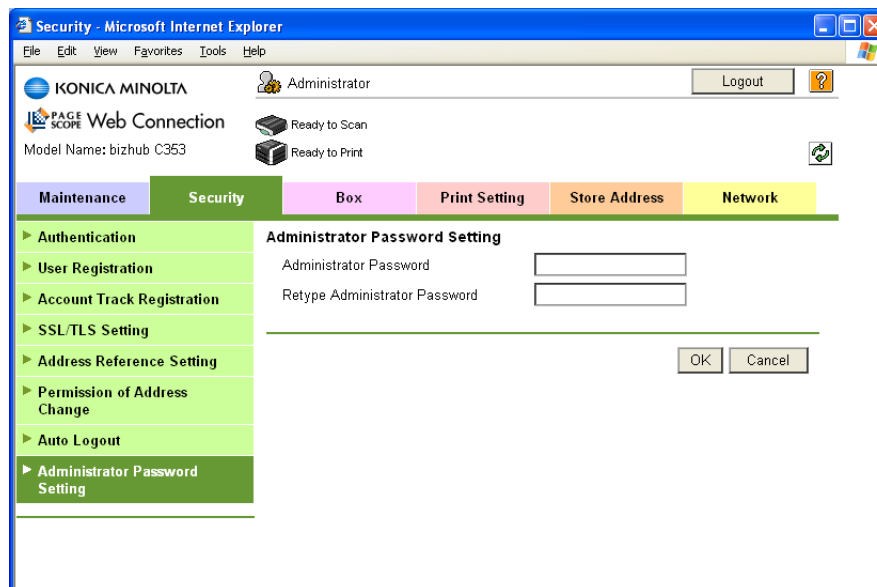

Item	Definition
Administrator Password	Specify the administrator password (up to 8 characters).
Retype Administrator Password	Enter the administrator password again for confirmation.



#### Detail

*If "Password Rules" is enabled, no password containing less than eight characters can be registered. If you have already registered a user password containing less than eight characters, change it to one using eight characters before enabling "Password Rules". For details on the password rules, refer to the User's Guide [Copy Operations].*

## 1.46 Box tab settings

This section describes other items specifiable on the Box tab for the PageScope Web Connection.

From the Box tab, user boxes can be created and basic user box information can be viewed.



### Note

For details on the box function, refer to the User's Guide [Box Operations].

### 1.46.1 Changing user box settings or deleting a user box

Change created user box settings or delete a user box.



### Detail

In Administrator mode, user box settings can be changed and a user box can be deleted without entering the user box password. In the user mode, files in the box can be operated. For details, refer to the User's Guide [Box Operations].

### Open User Box

In Administrator mode of PageScope Web Connection, select the Box tab - "Open User Box".

Specify the following settings.

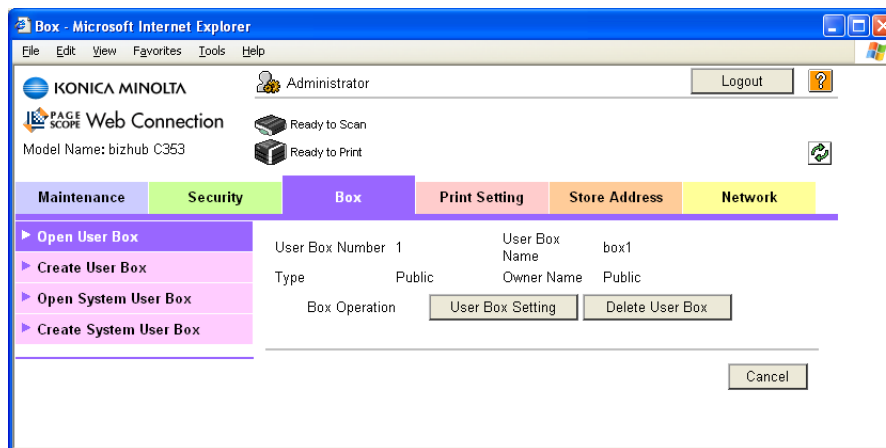

Item	Definition
[User Box Setting]	Changes the user box settings. When authentication is performed with PageScope Authentication Manager and logged in to the Administrator mode, and then the personal user box is selected, this menu item does not appear.
[Delete User Box]	Deletes the user box. When authentication is performed with PageScope Authentication Manager and logged in to the Administrator mode, and then the personal user box is selected, this menu item does not appear.

### User Box Setting

Item	Definition
User Box Number	Displays the user box number.
User Box Name	Specify the user box name (up to 20 characters).
Index	Specify the indexing characters.
Auto Delete Document	Specify the period during which data in the user box is saved.
User Box Expansion Function is changed.	To add the confidential reception function to the user box, specify the password (up to 8 characters). This setting appears when the optional fax kit is installed.
User Box Password is changed.	To change the user box password, select the check box. Specify the current password and the new password (up to 8 characters).

Item	Definition
User Box Owner is changed.	To change the user box owner, select this check box to select the box type. When authentication is performed with PageScope Authentication Manager and logged in to the Administrator mode, and then the public user box is selected, this menu item does not appear.

### 1.46.2 Creating a new user box

Create a new user box.



**Detail**

Public user boxes can be created only, and they cannot be changed in Administrator mode. For details on creating a user box, refer to the User's Guide [Box Operations].

**Create User Box**

In Administrator mode of PageScope Web Connection, select the Box tab - "Create User Box".

Specify the following settings.

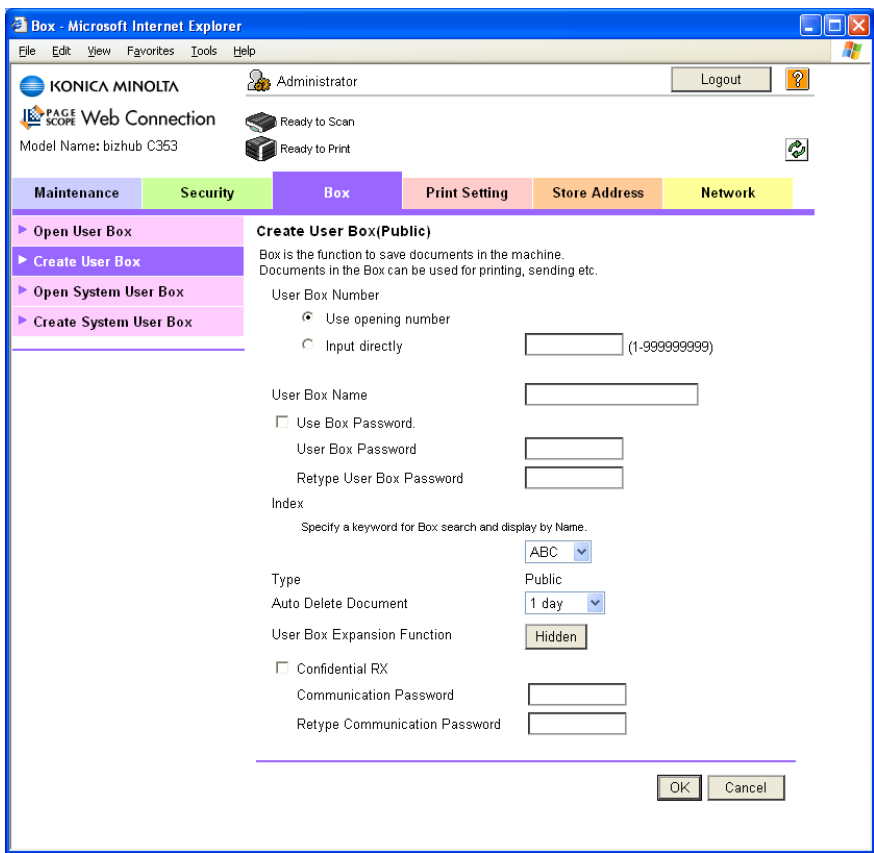

Item	Definition
User Box Number	Select the registration number of the box to be created ("Use opening number" or "Direct Input").
User Box Name	Specify the user box name (up to 20 characters). To specify the user box password, select the "Use Box Password" check box, and then specify the password (up to 8 characters).
Index	Specify the indexing characters.
Type	Specify the user box type. Public user boxes can be created only, and they cannot be changed in Administrator mode.
Auto Delete Document	Specify the period during which data in the user box is saved.
User Box Expansion Function	To add the confidential reception function to the user box, specify the password (up to 8 characters). This setting appears when the optional fax kit is installed.

**Detail**

If "Password Rules" is enabled, no password containing less than eight characters can be registered. If you have already registered a user password containing less than eight characters, change it to one using eight characters before enabling "Password Rules". For details on the password rules, refer to the User's Guide [Copy Operations].

### 1.46.3 Changing system box settings or deleting system boxes

Change the settings for created system boxes (bulletin board User box, relay user box, and annotation user box) or delete the boxes.

**Detail**

If the optional FAX kit is installed, "Bulletin Board User Box" and "Relay User Box" are selectable.

#### Open System User Box

In Administrator mode of PageScope Web Connection, select the Box tab - "Open System User Box".

Specify the following settings. (The screen when "Bulletin Board User Box" is selected)

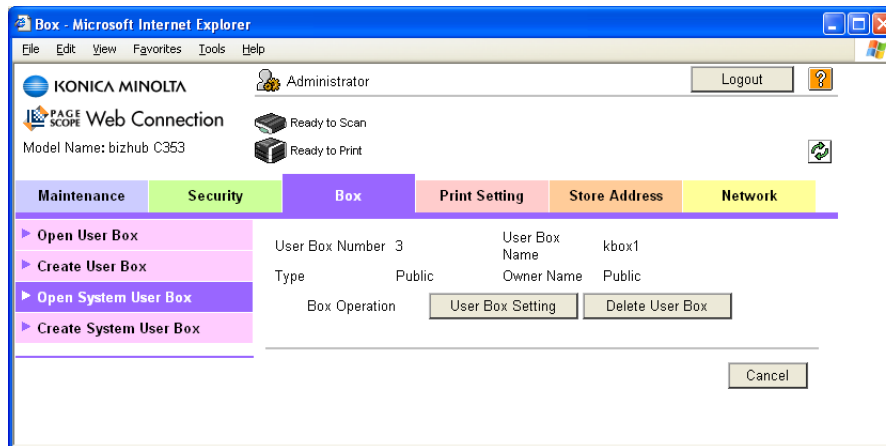

Item	Definition
[User Box Setting]	Changes the user box settings. When authentication is performed with PageScope Authentication Manager and logged in to the Administrator mode, and then the personal user box is selected, this menu item does not appear.
[Delete User Box]	Deletes the user box. When authentication is performed with PageScope Authentication Manager and logged in to the Administrator mode, and then the personal user box is selected, this menu item does not appear.

#### "Bulletin Board User Box" settings

Item	Definition
User Box Number	Displays the user box number.
User Box Name	Specify the user box name (up to 20 characters).
Auto Delete Document	Specify the period during which data in the user box is saved.
User Box Password is changed.	Change the user box password (up to 8 characters).
User Box Owner is changed.	To change the user box owner, select this check box, and then specify the box type. When authentication is performed with PageScope Authentication Manager and logged in to the Administrator mode, and then the public user box is selected, this menu item does not appear.

## "Relay User Box" settings

Item	Definition
User Box Number	Displays the user box number.
User Box Name	Specify the user box name (up to 20 characters).
Relay Address	Specify the relay address.
Relay TX Password is changed.	To change the relay user box password, select the check box. Specify the current password and the new password (up to 8 characters).

## "Annotation User Box" settings

Item	Definition
User Box Number	Displays the user box number.
User Box Name	Specify the user box name (up to 20 characters).
Auto Delete Document	Specify the period during which data in the user box is saved.
Change User Box Password	Change the user box password.
Change Count Up	To change the counting method, select the check box, and then specify the counting method. If the user box contains documents, the setting cannot be specified.
Change Stamp Elements	To change the text, select the check box, and then specify settings for "Primary field", "Secondary Field", "Date/Time", "Print Position", "Density", and "Number Type".

#### 1.46.4 Creating a new system user box

Create a new system user box.



##### Detail

*If the optional FAX kit is installed, "Bulletin Board User Box" and "Relay User Box" are selectable.*

#### Create System User Box

In Administrator mode of PageScope Web Connection, select the Box tab - "Create System User Box". Specify the following settings. (The screen when "Bulletin Board User Box" is selected)

When "Bulletin Board User Box" is selected

Item	Definition
User Box Number	Specify the registration number of the box to be created ("Use opening number" or "Direct Input").
User Box Name	Specify the user box name (up to 20 characters). To specify the user box password, select the "Use Box Password" check box, and then specify the password (up to 8 characters).
Type	Specify the user box type. Public user boxes can be created only, and they cannot be changed in Administrator mode.
Auto Delete Document	Specify the period during which data in the user box is saved.

When "Relay User Box" is selected

Item	Definition
User Box Number	Specify the registration number of the box to be created ("Use opening number" or "Direct Input").
User Box Name	Specify the user box name (up to 20 characters). To specify the user box password, select the "Use Box Password" check box, and then specify the password (up to 8 characters).
Relay Address	Specify the relay address.
Relay TX Password	Specify the relay TX password (up to 8 characters).
Retype Relay TX Password	Type in the relay TX password again.

When "Annotation User Box" is selected

Item	Definition
User Box Number	Specify the registration number of the box to be created ("Use opening number" or "Direct Input").
User Box Name	Specify the user box name (up to 20 characters). To specify the user box password, select the "Use Box Password" check box, and then specify the password (up to 8 characters).
Auto Delete Document	Specify the period during which data in the user box is saved.
Count Up	Select the counting method. If the user box contains documents, the setting cannot be specified.
Stamp Elements	Specify settings for "Primary Field", "Secondary Field", "Date/Time Setting", "Print Position", "Density", and "Number Type"



#### Detail

*If "Password Rules" is enabled, no password containing less than eight characters can be registered. If you have already registered a user password containing less than eight characters, change it to one using eight characters before enabling "Password Rules". For details on the password rules, refer to the User's Guide [Copy Operations].*

## 1.47 Print Setting tab settings

This section describes other items specifiable on the Print Setting tab for the PageScope Web Connection. On the Print Setting tab, specify settings for the print function of this machine.



### Note

For details on the print function, refer to the User's Guide [Print Operations].

### 1.47.1 Specifying initial settings for the print function

Specify initial settings for the print function.

#### Basic Setting

In Administrator mode of PageScope Web Connection, select the Print Setting tab - "Basic Setting".

Specify the following settings.

Item	Definition
PDL Setting	Specify the PDL language.
Paper Tray	Specify the paper tray.
Output Tray	Specify the output tray.
2-Sided Print	Specify whether to perform 2-sided print.
Bind Direction	Specify the binding direction.
Staple	Specify whether to perform staple. If yes, specify the number of staples.
Punch	Specify whether to perform punch.
Number of Sets	Specifies the number of copies to be printed.
Default Paper Size	Specifies the paper size.
Original Direction	Select the original direction.
Spool Print Jobs in HDD before RIP	Select whether to spool a print job to HDD.



Item	Definition
Banner Sheet Setting	Specify whether to print the first page on the banner page.
Banner Sheet Paper Tray	Select the default paper tray used for printing the banner pages.
No Matching Paper in Tray Setting	Specify whether to continue printing from a different paper tray when there is no paper of the appropriate size in the specified paper tray.
A4/A3←→LTR/LGR Auto Switch	Select whether to print an A4 (Letter)/A3 (Ledger) original in the same size with disregard to image missing when the Letter (A4)/Ledger (A3) paper tray is selected.
Binding Direction Adjustment	Specify the binding direction adjustment method.



#### Detail

*The staple function is available only if the optional finisher is installed.*

*The punch function is available only if the optional finisher and punch kit are installed.*

### 1.47.2 Specifying settings for PCL/PS/XPS print

Specify settings for PCL/PS/XPS print

#### PCL Settings

In Administrator mode of PageScope Web Connection, select the Print Setting tab - "PCL Setting".

Specify the following settings.

Item	Definition
Symbol Set	Specify the symbol set.
Typeface	Select the internal font ("Resident Font") or downloaded font ("Download Font").
Font Size	Specify the font size.
Line/Page	Specify the number of lines per page.
CR/LF Mapping	Specify the text data CR/LF replacement method.

## PS Setting

In Administrator mode of PageScope Web Connection, select the Print Setting tab - "PS Setting".  
Specify the following settings.

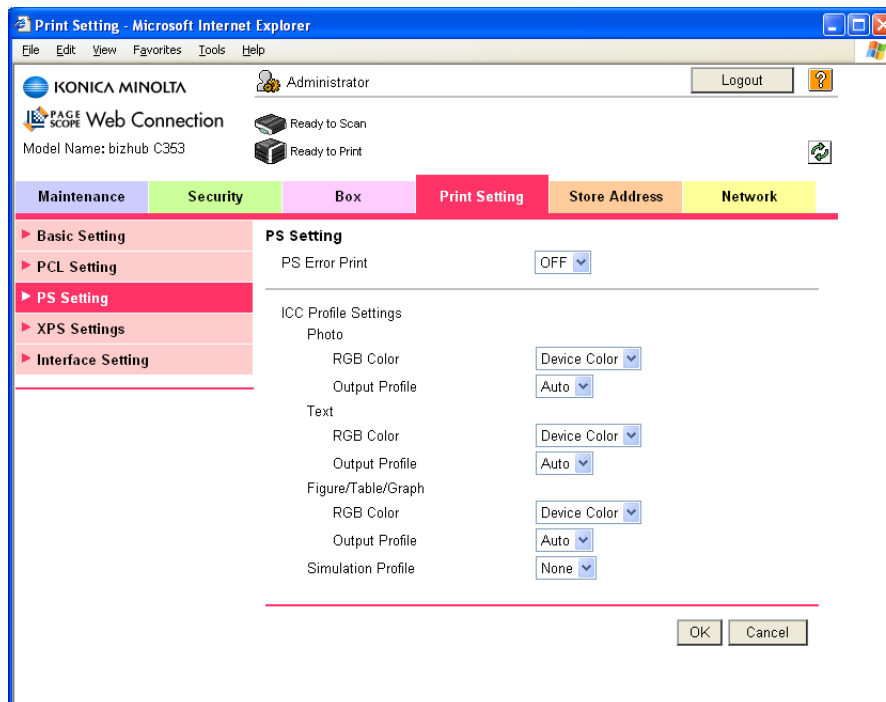

Item	Definition
PS Error Print	Specify whether to print error message when an error occurs during PS rasterization.
ICC Profile Settings	Specify the ICC profile.
Photo	Specify the default value of the profile when "Photo" is selected by the printer driver.
Text	Specify the default value of the profile when "Text" is selected by the printer driver.
Figure/Table/Graph	Specify the default value of the profile when "Figure/Table/Graph" is selected by the printer driver.
Simulation Profile	Specify the default value of the ICC profile for simulation.

### XPS Settings

In Administrator mode of PageScope Web Connection, select the Print Setting tab - "XPS Settings". Specify the following settings.

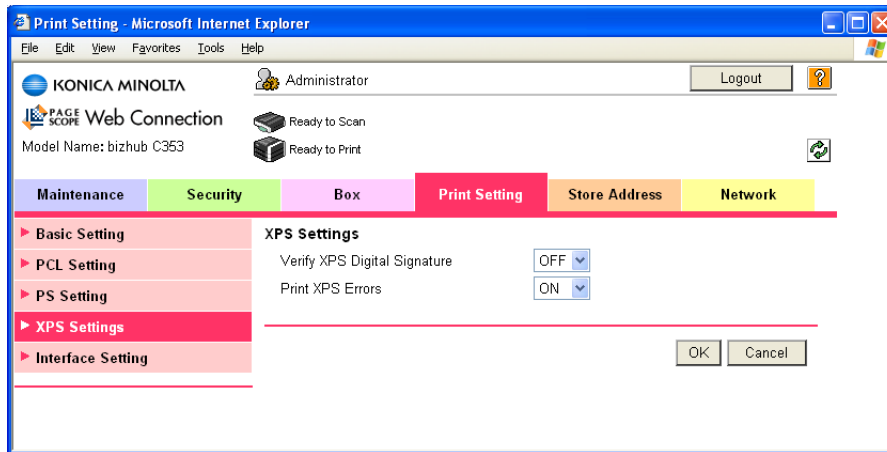

Item	Definition
Verify XPS Digital Signature	Specify whether to verify digital signature. When "ON" is selected, the document without a valid digital signature is not printed.
Print XPS Errors	Specify whether to print error message when an error occurs during XPS print.

### 1.47.3 Specifying the interface timeout

Specify the time period before the interfaced connection times out.

#### Interface Setting

In Administrator mode of PageScope Web Connection, select the Print Setting tab - "Interface Setting". Specify the following settings.

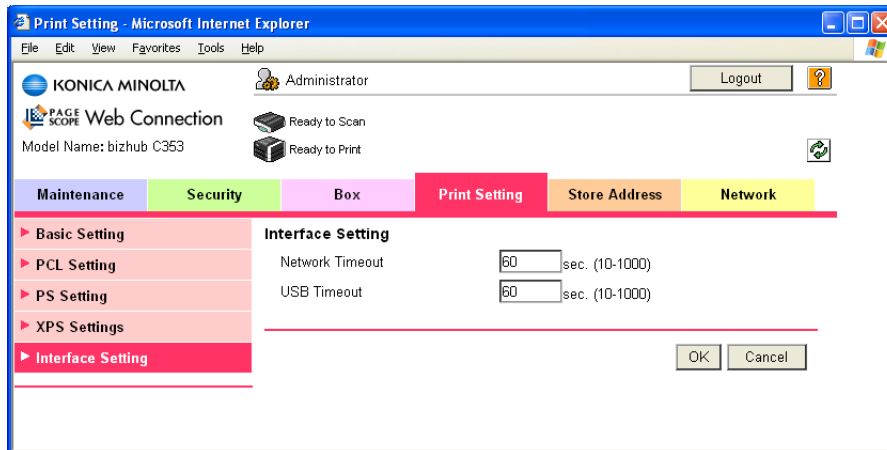

Item	Definition
Network Timeout	Specify the reception timeout for the network.
USB Timeout	Specify the USB timeout.

## 1.48 Store Address tab settings

From the Store Address tab, transmission destinations and user box destinations for saving data can be registered and their settings can be changed.



### Detail

When users are permitted to register addresses, address registration and modification are available in the User mode as well. For details on settings whether or not to permit address registration by users, refer to "[Restricting address registration by a user](#)" on page 1-143.

### 1.48.1 Registering or editing an address book destination

Register a new address book, change address book settings or register icons.

Register destinations in the address book in advance, and then they are selectable when sending. Also, an icon can be registered to a registered address book.

#### Store Address

In Administrator mode of PageScope Web Connection, select the Store Address tab - "Address Book" - "Store Address".

Specify the following settings.

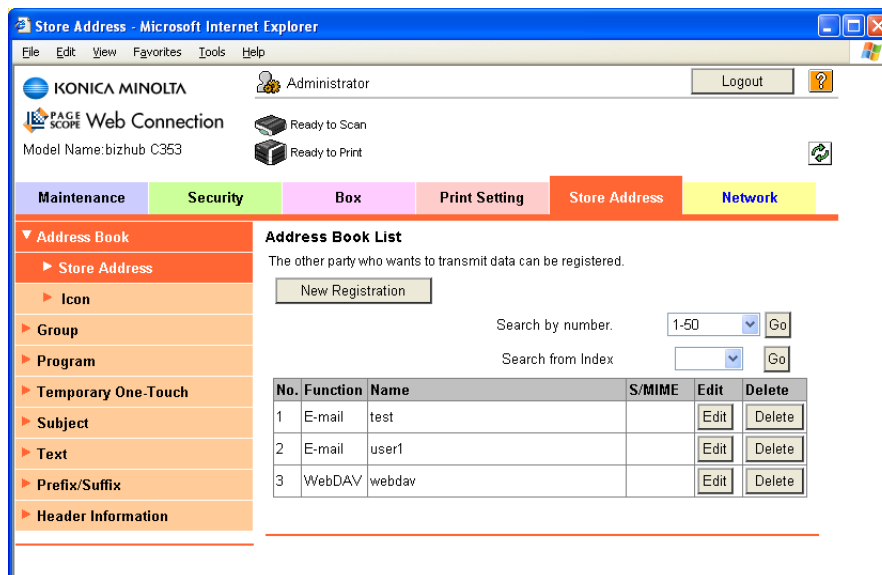

Item	Definition
[New Registration]	Registers a new destination in the address book.
Search from Number	Select a range of registration numbers, and then click [Go] to display the list of destinations of the selected number.
Search from Index	Select the search text, and then click [Go] to display the list of destinations of the selected texts.
No.	Displays the registration number.
Function	Displays functions for which addresses were registered.
Name	Displays registered names.
S/MIME	Shows whether or not a certificate is attached to the E-mail destination.
[Edit]	Edits the registered address. The settings are the same as ones available during registration.
[Delete]	Deletes the address from the address book.

When "E-mail" was selected using [New Registration]

Item	Definition
No.	Specify the registration number ("Use opening number" or "Direct Input").
Name	Type in the address name (up to 24 characters).
Index	Specify the index characters for the destination. To normally display the destination in the control panel, select the "Main" check box.
E-mail Address	Enter the address for the destination (up to 320 characters).
Registration of Certification Information	Select this check box to register certificate information. Select the "Registration of Certification Information" check box. Click [Browse...], and then specify the certificate information. Only files in the DER (Distinguished Encoding Rules) format are supported for certificate information. To delete the certificate information, select "Deletion of Certification Information". If the E-Mail address to be registered does not match the E-Mail address of the certificate, the certificate cannot be registered. Confirm whether both E-Mail addresses match, and then register the certificate.
Limiting Access to Destinations	Specify the group that is allowed to access a destination and reference allowed level.

When "FTP" was selected using [New Registration]

Item	Definition
No.	Specify the registration number ("Use opening number" or "Direct Input").
Name	Type in the address name (up to 24 characters).
Index	Specify the index characters for the destination. To normally display the destination in the control panel, select the "Main" check box.
Host Address	Specify the IP address of the FTP server of the destination. If the DNS server is specified, the address can be specified using the host name (up to 63 characters).
File Path	Specify the directory of the destination (up to 96 characters).
User ID	Type in the user ID for logging in to the FTP server of the destination (up to 47 characters).
Password	Type in the password for logging in to the FTP server of the destination (up to 31 characters).
anonymous	Specify whether even an anonymous user can access the destination.
PASV Mode	Register whether to make communication in the PASV mode.
Proxy	Specifies whether or not a proxy server is used.
Port Number	Specify the port number to be used.
Limiting Access to Destinations	Specify the group that is allowed to access a destination and reference allowed level.

When "SMB" was selected using [New Registration]

Item	Definition
No.	Specify the registration number ("Use opening number" or "Direct Input").
Name	Type in the address name (up to 24 characters).
Index	Specify the index characters for the destination. To normally display the destination in the control panel, select the "Main" check box.
Host Address	Specify the IP address of the computer of the destination. If the DNS server is specified, the address can be specified using the host name (up to 255 characters).
File Path	Specify the directory of the destination (up to 255 characters).
User ID	Type in the user ID for logging in to the computer of the destination (up to 127 characters).
Password	Type in the password for logging in to the computer of the destination (up to 14 characters).
Limiting Access to Destinations	Specify the group that is allowed to access a destination and reference allowed level.

When "WebDAV" was selected using [New Registration]

Item	Definition
No.	Specify the registration number ("Use opening number" or "Direct Input").
Name	Type in the address name (up to 24 characters).
Index	Specify the index characters for the destination. To normally display the destination in the control panel, select the "Main" check box.
Host Address	Specify the IP address of the WebDAV server of the destination. If the DNS server is specified, the address can be specified using the host name (up to 255 characters).
File Path	Specify the directory of the destination (up to 47 characters).
User ID	Type in the user ID for logging in to the WebDAV server of the destination (up to 21 characters).
Password	Type in the password for logging in to the WebDAV server of the destination (up to 63 characters).
SSL Settings	Specify whether perform encryption using SSL.
Proxy	Specifies whether or not a proxy server is used.
Port No.	Specify the port number to be used.
Limiting Access to Destinations	Specify the group that is allowed to access a destination and reference allowed level.

When "User Box" was selected using [New Registration]

Item	Definition
No.	Specify the registration number ("Use opening number" or "Direct Input").
Name	Type in the address name (up to 24 characters).
Index	Specify the index characters for the destination. To normally display the destination in the control panel, select the "Main" check box.
User Box No.	Specify the user box number of the destination.
Limiting Access to Destinations	Specify the group that is allowed to access a destination and reference allowed level.

When "Fax" was selected using [New Registration]



#### Detail

*Appears if the optional fax kit has been installed.*

Item	Definition
No.	Specify the registration number ("Use opening number" or "Direct Input").
Name	Type in the address name (up to 24 characters).
Index	Specify the index characters for the destination. To normally display the destination in the control panel, select the "Main" check box.
Destination	Enter the fax number for the destination (up to 38 characters).
Confirm Fax Number	Enter the fax number again in order to prevent misentering of the fax number. This menu item appears when "Confirm Address (TX)" is set to [ON] from the control panel.
Line Setting	Specify the line to be used. This item is enabled if the optional fax multi line is installed.
Communication Setting	Click [Display], and then select the check box for the displayed item ("V34 off", "ECM Off", "International Communication" or "Check Dest. & Send").
Limiting Access to Destinations	Specify the group that is allowed to access a destination and reference allowed level.

When "IP Address Fax" was selected using [New Registration]

Item	Definition
No.	Specify the registration number ("Use opening number" or "Direct Input").
Name	Type in the address name (up to 24 characters).
Index	Specify the index characters for the destination. To normally display the destination in the control panel, select the "Main" check box.
Host Address	Specify the IP address of the fax of the destination. If the DNS server is specified, the address can be specified using the host name (up to 63 characters).
Port No.	Specify the port number to be used.
Machine Type of Destination	Specify whether the destination is a color or monochrome machine.
Limiting Access to Destinations	Specify the group that is allowed to access a destination and reference allowed level.

When "Internet Fax" was selected using [New Registration]



#### Detail

*This window appears if the Internet fax function is available.*

Item	Definition
No.	Specify the registration number ("Use opening number" or "Direct Input").
Name	Type in the address name (up to 24 characters).
Index	Specify the index characters for the destination. To normally display the destination in the control panel, select the "Main" check box.
E-mail Address	Enter the address for the destination (up to 320 characters).
Resolution	Specifies the resolution.
Paper Size	Specifies the paper size.
Compression Type	Specify the compression method.
Limiting Access to Destinations	Specify the group that is allowed to access a destination and reference allowed level.

#### Icon

In Administrator mode of PageScope Web Connection, select the Store Address tab - "Address Book" - "Icon" - "Edit".

Specify the following settings.

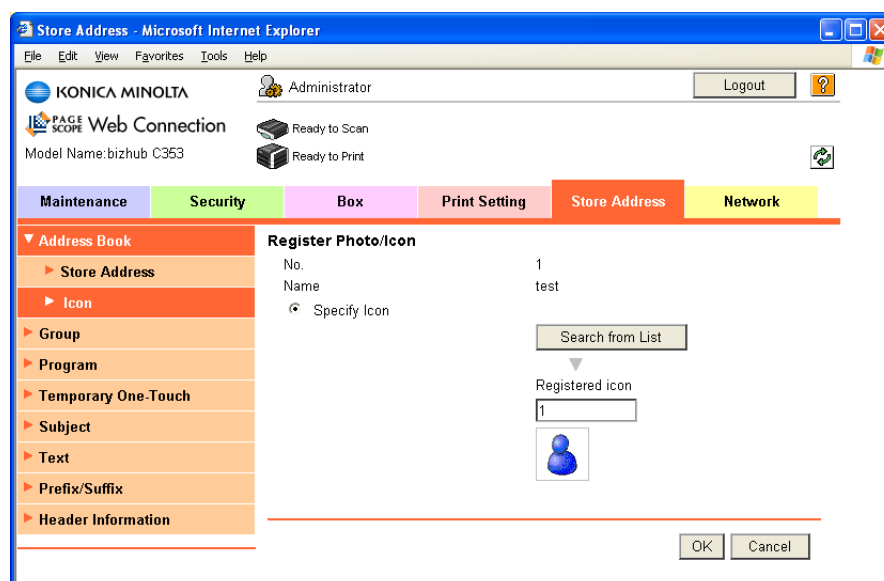

Item	Description
No.	The registration number of the address book appears.
Name	The registered name of the address book appears.
Specify Icon	Select "Specify Icon".
[Search from List]	The icon list appears. Select an icon to be registered.

### 1.48.2 Registering or editing a group destination

Register a new group destination or change group destination settings.

Register multiple addresses as a group destination by grouping. To broadcast the fax, use this function. To register addresses in a group, they must be registered in the address book in advance.

#### Group

In Administrator mode of PageScope Web Connection, select the Store Address tab - "Group".

Specify the following settings.

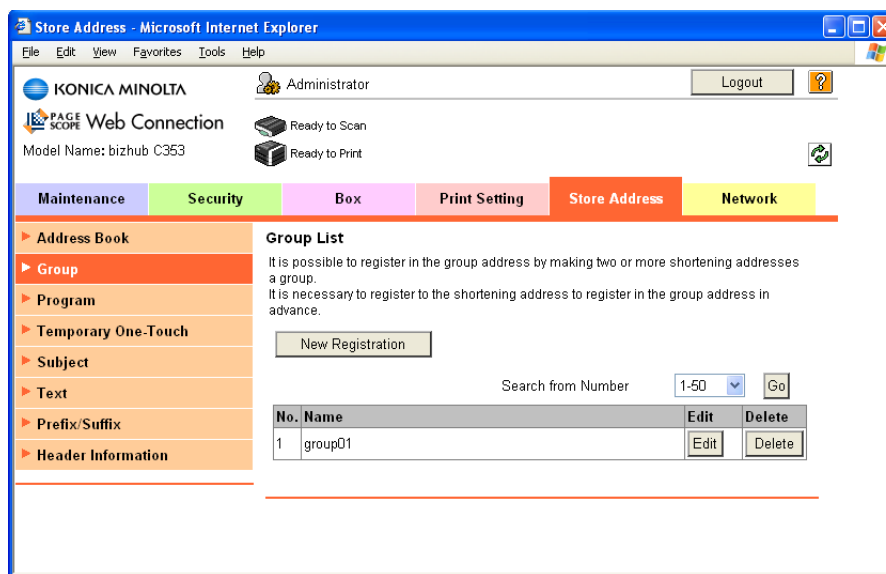

Item	Definition
[New Registration]	Registers a new group destination.
Search from Number	Select a range of registration numbers, and then click [Go] to display the list of destinations of the selected number.
No.	Displays the registration number.
Name	Displays registered names.
[Edit]	Edits the registered group destination. The settings are the same as ones available during registration.
[Delete]	Deletes the group destination.

#### New Registration

Item	Definition
Name	Enter the group name (up to 24 characters).
Scan/Fax Address	Select the scan/fax address to be grouped. Select addresses to be grouped from the list of registered addresses.
User Box	Select the user boxes to be grouped. Select addresses to be grouped from the list of registered addresses.
[Check Destination]	Checks registered destinations.
Specify Icon	From [Search from List], specify an icon for the user to be registered.



Item	Definition
Limiting Access to Destinations	Specify the group that is allowed to access a destination and reference allowed level.

### 1.48.3 Registering or editing a program destination

Register a new group destination or change program destination settings.

Program destinations can be registered by combining address information, communication information, and original information.

#### Program address

In Administrator mode of PageScope Web Connection, select the Store Address tab - "Program".

Specify the following settings.

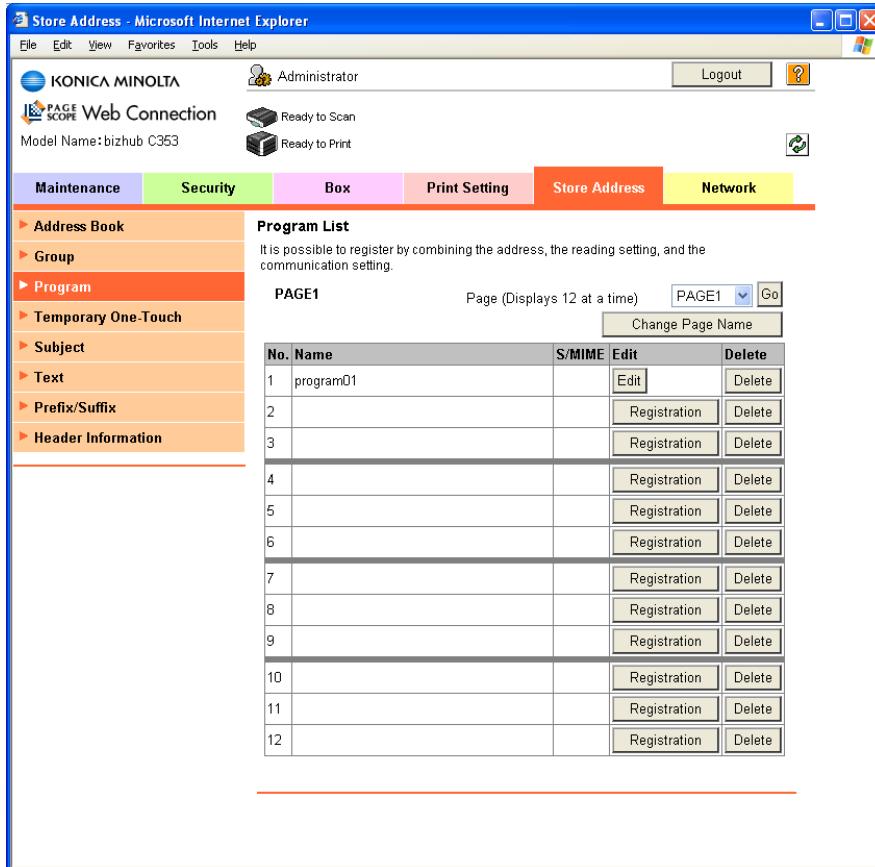

Item	Definition
Page (Display 12 at a time)	Select the page, and then click [Go] to display the list of destinations of the selected page.
[Change Page Name]	Renames the page.
No.	Displays the registration number.
Name	Displays registered names.
S/MIME	Displays whether or not the certificate is attached.
[Registration]	Registers the program destination.
[Edit]	Edits the registered program destination. The settings are the same as ones available during registration.
[Delete]	Deletes the program destination.

When "E-mail" was selected using [Registration]

Item	Definition
No.	Displays the registration number.
Name	Type in the registration name (up to 24 characters).
Destination Information	Specify the address information. Select "Select from Address Book" or "Direct Input".
Resolution	Specifies the resolution.
File Type	Specify the file format.
File Name	Specify the file name (up to 30 characters).
Page Setting	Specify the unit of data to be saved.
Subject	Specify the E-mail subject. To use the default subject, select "Not Specified". To check the contents of the subject, click [Subject List].
Text	Specify the E-mail text. To use the default subject, select "Not Specified". To check the contents of the subject, click [Text List].
Simplex/Duplex	Specify whether the original is 2-sided.
Original Type	Specify the quality of the original, such as text or photo.
Color	Specify the color mode for scanning.
Separate Scan	Specify whether to divide scanning of the original.
Density	Specify the density.
Background Removal	Adjust the density of the background.
Scan Size	Specify the original size ("Auto", "Standard Size" or "Custom Size"). If "Standard Size" is selected, select the size and the feed direction. If "Custom Size" is selected, specify the height and width.
Application Setting	Click the [Display] button, and then specify settings for the functions that are displayed.
Original Direction	Specify the original orientation.
2-Sided Binding Direction	Specify the binding orientation of the original.
Special Original	Specify the original in a different size.
Book Scan	Specify whether to perform book scan.
Erase	Specify whether to perform frame erase.
Compose (Date/Time)	Specify whether to print the date/time. If yes, specify settings for "Date Type", "Time Type", "Print Position", "Fine-Tune", "Color", "Pages", and "Size".
Compose (Page)	Specify whether to print page numbers. If yes, specify settings for "Page Number", "Chapter", "Page Number Type", "Print Position", "Fine-Tune", "Color", and "Size".
Compose (Header/Footer)	Selects whether to print a header/footer. If yes, specify the registration number of the header/footer. To check the registered header/footer, click [Confirm Registered Contents].
Compose (Stamp)	Specify whether to print the stamp. If yes, specify settings for "Preset Stamp" or "Registered Stamp", "Print Position", "Fine-Tune", "Color", "Pages", and "Size". To check the registered stamp, click [Confirm Registered Contents]. To use the registered stamp function, stamps must be registered from the control panel in advance.
Stamp Combine Method	Specify the stamp composition method.
Limiting Access to Destinations	Click [Display], and then specify the group that is allowed to access a destination and reference allowed level.

When "FTP" was selected using [Registration]

Item	Definition
No.	Displays the registration number.
Name	Type in the registration name (up to 24 characters).
Destination Information	Specify the address information. Select "Select from Address Book" or "Direct Input".
Resolution	Specifies the resolution.

Item	Definition
File Type	Specify the file format.
File Name	Specify the file name (up to 30 characters).
Page Setting	Specify the unit of data to be saved.
Simplex/Duplex	Specify whether the original is 2-sided.
Original Type	Specify the quality of the original, such as text or photo.
Color	Specify the color mode for scanning.
Separate Scan	Specify whether to divide scanning of the original.
Density	Specify the density.
Background Removal	Adjust the density of the background.
Scan Size	Specify the original size ("Auto", "Standard Size" or "Custom Size"). If "Standard Size" is selected, select the size and the feed direction. If "Custom Size" is selected, specify the height and width.
Application Setting	Click the [Display] button, and then specify settings for the functions that are displayed.
E-mail Notification	Specify whether to send notification of scan data URL. Specify the notification address for "Address". To select a destination from the list, click [Search from List].
Original Direction	Specify the original orientation.
2-Sided Binding Direction	Specify the binding orientation of the original.
Special Original	Specify the original in a different size.
Book Scan	Specify whether to perform book scan.
Erase	Specify whether to perform frame erase.
Compose (Date/Time)	Specify whether to print the date/time. If yes, specify settings for "Date Type", "Time Type", "Print Position", "Fine-Tune", "Color", "Pages", and "Size".
Compose (Page)	Specify whether to print page numbers. If yes, specify settings for "Page Number", "Chapter", "Print Position", "Fine-Tune", "Color", and "Size".
Compose (Header/Footer)	Specify whether to print a header/footer. If yes, specify the registration number of the header/footer. To check the registered header/footer, click [Confirm Registered Contents].
Compose (Stamp)	Specify whether to print the stamp. If yes, specify settings for "Preset Stamp" or "Registered Stamp", "Print Position", "Fine-Tune", "Color", "Pages", and "Size". To check the registered stamp, click [Confirm Registered Contents]. To use the registered stamp function, stamps must be registered from the control panel in advance.
Stamp Combine Method	Specify the stamp composition method.
Limiting Access to Destinations	Click [Display], and then specify the group that is allowed to access a destination and reference allowed level.

When "SMB" was selected using [Registration]

Item	Definition
No.	Displays the registration number.
Name	Type in the registration name (up to 24 characters).
Destination Information	Specify the address information. Select "Select from Address Book" or "Direct Input".
Resolution	Specifies the resolution.
File Type	Specify the file format.
File Name	Specify the file name (up to 30 characters).
Page Setting	Specify the unit of data to be saved.
Simplex/Duplex	Specify whether the original is 2-sided.
Original Type	Specify the quality of the original, such as text or photo.
Color	Specify the color mode for scanning.
Separate Scan	Specify whether to divide scanning of the original.

Item	Definition
Density	Specify the density.
Background Removal	Adjust the density of the background.
Scan Size	Specify the original size ("Auto", "Standard Size" or "Custom Size"). If "Standard Size" is selected, select the size and the feed direction. If "Custom Size" is selected, specify the height and width.
Application Setting	Click the [Display] button, and then specify settings for the functions that are displayed.
E-mail Notification	Specify whether to send notification of scan data URL. Specify the notification address for "Address". To select a destination from the list, click [Search from List].
Original Direction	Specify the original orientation.
2-Sided Binding Direction	Specify the binding orientation of the original.
Special Original	Specify the original in a different size.
Book Scan	Specify whether to perform book scan.
Erase	Specify whether to perform frame erase.
Compose (Date/Time)	Specify whether to print the date/time. If yes, specify settings for "Date Type", "Time Type", "Print Position", "Fine-Tune", "Color" "Pages", and "Size".
Compose (Page)	Specify whether to print page numbers. If yes, specify settings for "Page Number", "Chapter", "Print Position", "Fine-Tune", "Color", and "Size".
Compose (Header/Footer)	Specify whether to print a header/footer. If yes, specify the registration number of the header/footer. To check the registered header/footer, click [Confirm Registered Contents].
Compose (Stamp)	Specify whether to print the stamp. If yes, specify settings for "Preset Stamp" or "Registered Stamp", "Print Position", "Fine-Tune", "Color", "Pages", and "Size". To check the registered stamp, click [Confirm Registered Contents]. To use the registered stamp function, stamps must be registered from the control panel in advance.
Stamp Combine Method	Specify the stamp composition method.
Limiting Access to Destinations	Click [Display], and then specify the group that is allowed to access a destination and reference allowed level.

When "WebDAV" was selected using [Registration]

Item	Definition
No.	Displays the registration number.
Name	Type in the registration name (up to 24 characters).
Destination Information	Specify the address information. Select "Select from Address Book" or "Direct Input".
Resolution	Specifies the resolution.
File Type	Specify the file format.
File Name	Specify the file name (up to 30 characters).
Page Setting	Specify the unit of data to be saved.
Simplex/Duplex	Specify whether the original is 2-sided.
Original Type	Specify the quality of the original, such as text or photo.
Color	Specify the color mode for scanning.
Separate Scan	Specify whether to divide scanning of the original.
Density	Specify the density.
Background Removal	Adjust the density of the background.
Scan Size	Specify the original size ("Auto", "Standard Size" or "Custom Size"). If "Standard Size" is selected, select the size and the feed direction. If "Custom Size" is selected, specify the height and width.
Application Setting	Click the [Display] button, and then specify settings for the functions that are displayed.
E-mail Notification	Specify whether to send notification of scan data URL. Specify the notification address for "Address". To select a destination from the list, click [Search from List].

Item	Definition
Original Direction	Specify the original orientation.
2-Sided Binding Direction	Specify the binding orientation of the original.
Special Original	Specify the original in a different size.
Book Scan	Specify whether to perform book scan.
Erase	Specify whether to perform frame erase.
Compose (Date/Time)	Specify whether to print the date/time. If yes, specify settings for "Date Type", "Time Type", "Print Position", "Fine-Tune", "Color", "Pages", and "Size".
Compose (Page)	Specify whether to print page numbers. If yes, specify settings for "Page Number", "Chapter", "Print Position", "Fine-Tune", "Color", and "Size".
Compose (Header/Footer)	Specify whether to print a header/footer. If yes, specify the registration number of the header/footer. To check the registered header/footer, click [Confirm Registered Contents].
Compose (Stamp)	Specify whether to print the stamp. If yes, specify settings for "Preset Stamp" or "Registered Stamp", "Print Position", "Fine-Tune", "Color", "Pages", and "Size". To check the registered stamp, click [Confirm Registered Contents]. To use the registered stamp function, stamps must be registered from the control panel in advance.
Stamp Combine Method	Specify the stamp composition method.
Limiting Access to Destinations	Click [Display], and then specify the group that is allowed to access a destination and reference allowed level.

When "User Box" was selected using [Registration]

Item	Definition
No.	Displays the registration number.
Name	Type in the registration name (up to 24 characters).
Destination Information	Specify the address information. Select "Select from Address Book" or "Direct Input".
Resolution	Specifies the resolution.
File Type	Specify the file format.
File Name	Specify the file name (up to 30 characters).
Page Setting	Specify the unit of data to be saved.
Simplex/Duplex	Specify whether the original is 2-sided.
Original Type	Specify the quality of the original, such as text or photo.
Color	Specify the color mode for scanning.
Separate Scan	Specify whether to divide scanning of the original.
Density	Specify the density.
Background Removal	Adjust the density of the background.
Scan Size	Specify the original size ("Auto", "Standard Size" or "Custom Size"). If "Standard Size" is selected, select the size and the feed direction. If "Custom Size" is selected, specify the height and width.
Application Setting	Click the [Display] button, and then specify settings for the functions that are displayed.
E-mail Notification	Specify whether to send notification of scan data URL. Specify the notification address for "Address". To select a destination from the list, click [Search from List].
Original Direction	Specify the original orientation.
2-Sided Binding Direction	Specify the binding orientation of the original.
Special Original	Specify the original in a different size.
Book Scan	Specify whether to perform book scan.
Erase	Specify whether to perform frame erase.

Item	Definition
Compose (Date/Time)	Specify whether to print the date/time. If yes, specify settings for "Date Type", "Time Type", "Print Position", "Fine-Tune", "Color", "Pages", and "Size".
Compose (Page)	Specify whether to print page numbers. If yes, specify settings for "Page Number", "Chapter", "Print Position", "Fine-Tune", "Color", and "Size".
Compose (Header/Footer)	Specify whether to print a header/footer. If yes, specify the registration number of the header/footer. To check the registered header/footer, click [Confirm Registered Contents].
Compose (Stamp)	Specify whether to print the stamp. If yes, specify settings for "Preset Stamp" or "Registered Stamp", "Print Position", "Fine-Tune", "Color", "Pages", and "Size". To check the registered stamp, click [Confirm Registered Contents]. To use the registered stamp function, stamps must be registered from the control panel in advance.
Stamp Combine Method	Specify the stamp composition method.
Limiting Access to Destinations	Click [Display], and then specify the group that is allowed to access a destination and reference allowed level.

When "Fax" was selected using [Registration]

Item	Definition
No.	Displays the registration number.
Name	Type in the registration name (up to 24 characters).
Destination Information	Specify the address information. Select "Select from Address Book" or "Direct Input".
Resolution	Specifies the resolution.
File Type	Specify the file format.
Simplex/Duplex	Specify whether the original is 2-sided.
Original Type	Specify the quality of the original, such as text or photo.
Separate Scan	Specify whether to divide scanning of the original.
Density	Specify the density.
Background Removal	Adjust the density of the background.
Scan Size	Specify the original size ("Auto", "Standard Size" or "Custom Size"). If "Standard Size" is selected, select the size and the feed direction. If "Custom Size" is selected, specify the height and width.
Application Setting	Click the [Display] button, and then specify settings for the functions that are displayed.
Timer TX	Specify whether to perform timer communication. If yes, enter the transmission time.
Password TX	Specify whether to send the password. If yes, enter the password.
F-Code	Specify whether to send the password using F code. If "Enable" is selected, type in the SUB address and password.
2-Sided Binding Direction	Specify the binding orientation of the original.
Special Original	Specify the original in a different size.
Erase	Specify whether to perform frame erase.
Compose (Date/Time)	Specify whether to print the date/time. If yes, specify settings for "Date Type", "Time Type", "Print Position", "Fine-Tune", "Color", "Pages", and "Size".
Compose (Page)	Specify whether to print page numbers. If yes, specify settings for "Page Number", "Chapter", "Page Number Type", "Print Position", "Fine-Tune", "Color", and "Size".
Compose (Header/Footer)	Specify whether to print a header/footer. If yes, specify the registration number of the header/footer. To check the registered header/footer, click [Confirm Registered Contents].
Compose (Stamp)	Specify whether to print the stamp. If yes, specify settings for "Preset Stamp" or "Registered Stamp", "Print Position", "Fine-Tune", "Color", "Pages", and "Size". To check the registered stamp, click [Confirm Registered Contents]. To use the registered stamp function, stamps must be registered from the control panel in advance.
Stamp Combine Method	Specify the stamp composition method.

Item	Definition
Limiting Access to Destinations	Click [Display], and then specify the group that is allowed to access a destination and reference allowed level.

When "IP Address Fax" was selected using [Registration]

Item	Definition
No.	Displays the registration number.
Name	Type in the registration name (up to 24 characters).
Destination Information	Specify the address information. Select "Select from Address Book" or "Direct Input".
Resolution	Specifies the resolution.
File Type	Specify the file format.
Simplex/Duplex	Specify whether the original is 2-sided.
Original Type	Specify the quality of the original, such as text or photo.
Color	Specify the color mode for scanning.
Separate Scan	Specify whether to divide scanning of the original.
Density	Specify the density.
Background Removal	Adjust the density of the background.
Scan Size	Specify the original size ("Auto", "Standard Size" or "Custom Size"). If "Standard Size" is selected, select the size and the feed direction. If "Custom Size" is selected, specify the height and width.
Application Setting	Click the [Display] button, and then specify settings for the functions that are displayed.
Password TX	Specify whether to send the password. If yes, enter the password.
F-Code	Specify whether to send the password using F code. If "Enable" is selected, type in the SUB address and password.
2-Sided Binding Direction	Specify the binding orientation of the original.
Special Original	Specify the original in a different size.
Erase	Specify whether to perform frame erase.
Compose (Date/Time)	Specify whether to print the date/time. If yes, specify settings for "Date Type", "Time Type", "Print Position", "Fine-Tune", "Color" "Pages", and "Size".
Compose (Page)	Specify whether to print page numbers. If yes, specify settings for "Page Number", "Chapter", "Print Position", "Fine-Tune", "Color", and "Size".
Compose (Header/Footer)	Specify whether to print a header/footer. If yes, specify the registration number of the header/footer. To check the registered header/footer, click [Confirm Registered Contents].
Compose (Stamp)	Specify whether to print the stamp. If yes, specify settings for "Preset Stamp" or "Registered Stamp", "Print Position", "Fine-Tune", "Color", "Pages", and "Size". To check the registered stamp, click [Confirm Registered Contents]. To use the registered stamp function, stamps must be registered from the control panel in advance.
Stamp Combine Method	Specify the stamp composition method.
Limiting Access to Destinations	Click [Display], and then specify the group that is allowed to access a destination and reference allowed level.

When "Internet Fax" was selected using [Registration]

Item	Definition
No.	Displays the registration number.
Name	Type in the registration name (up to 24 characters).
Destination Information	Specify the address information. Select "Select from Address Book" or "Direct Input".
Resolution	Specifies the resolution.

Item	Definition
Subject	Specify the E-mail subject. To use the default subject, select "Not Specified". To check the contents of the subject, click [Subject List].
Text	Specify the E-mail text. To use the default subject, select "Not Specified". To check the contents of the subject, click [Text List].
Simplex/Duplex	Specify whether the original is 2-sided.
Original Type	Specify the quality of the original, such as text or photo.
Separate Scan	Specify whether to divide scanning of the original.
Density	Specify the density.
Background Removal	Adjust the density of the background.
Scan Size	Specify the original size ("Auto", "Standard Size" or "Custom Size"). If "Standard Size" is selected, select the size and the feed direction. If "Custom Size" is selected, specify the height and width.
Application Setting	Click the [Display] button, and then specify settings for the functions that are displayed.
2-Sided Binding Direction	Specify the binding orientation of the original.
Special Original	Specify the original in a different size.
Erase	Specify whether to perform frame erase.
Compose (Date/Time)	Specify whether to print the date/time. If yes, specify settings for "Date Type", "Time Type", "Print Position", "Fine-Tune", "Color", "Pages", and "Size".
Compose (Page)	Specify whether to print page numbers. If yes, specify settings for "Page Number", "Chapter", "Print Position", "Fine-Tune", "Color", and "Size".
Compose (Header/Footer)	Specify whether to print a header/footer. If yes, specify the registration number of the header/footer. To check the registered header/footer, click [Confirm Registered Contents].
Compose (Stamp)	Specify whether to print the stamp. If yes, specify settings for "Preset Stamp" or "Registered Stamp", "Print Position", "Fine-Tune", "Color", "Pages", and "Size". To check the registered stamp, click [Confirm Registered Contents]. To use the registered stamp function, stamps must be registered from the control panel in advance.
Limiting Access to Destinations	Click [Display], and then specify the group that is allowed to access a destination and reference allowed level.

When "Group" was selected using [Registration]

Item	Definition
No.	Displays the registration number.
Name	Type in the registration name (up to 24 characters).
Destination Information	Specify the address information. Select "Select from Address Book" or "Direct Input".
Resolution	Specifies the resolution.
File Type	Specify the file format.
File Name	Specify the file name (up to 30 characters).
Page Setting	Specify the unit of data to be saved.
Subject	Specify the E-mail subject. To use the default subject, select "Not Specified". To check the contents of the subject, click [Subject List].
Text	Specify the E-mail text. To use the default subject, select "Not Specified". To check the contents of the subject, click [Text List].
Simplex/Duplex	Specify whether the original is 2-sided.
Original Type	Specify the quality of the original, such as text or photo.
Color	Specify the color mode for scanning.
Separate Scan	Specify whether to divide scanning of the original.



Item	Definition
Density	Specify the density.
Background Removal	Adjust the density of the background.
Scan Size	Specify the original size ("Auto", "Standard Size" or "Custom Size"). If "Standard Size" is selected, select the size and the feed direction. If "Custom Size" is selected, specify the height and width.
Application Setting	Click the [Display] button, and then specify settings for the functions that are displayed.
E-mail Notification	Specify whether to send notification of scan data URL. Specify the notification address for "Address". To select a destination from the list, click [Search from List].
Timer TX	Specify whether to perform timer communication. If yes, enter the transmission time.
Password TX	Specify whether to send the password. If yes, enter the password.
F-Code	Specify whether to send the password using F code. If "Enable" is selected, type in the SUB address and password.
Original Direction	Specify the original orientation.
2-Sided Binding Direction	Specify the binding orientation of the original.
Special Original	Specify the original in a different size.
Book Scan	Specify whether to perform book scan.
Erase	Specify whether to perform frame erase.
Compose (Date/Time)	Specify whether to print the date/time. If yes, specify settings for "Date Type", "Time Type", "Print Position", "Fine-Tune", "Color" "Pages", and "Size".
Compose (Page)	Specify whether to print page numbers. If yes, specify settings for "Page Number", "Chapter", "Print Position", "Fine-Tune", "Color", and "Size".
Compose (Header/Footer)	Specify whether to print a header/footer. If yes, specify the registration number of the header/footer. To check the registered header/footer, click [Confirm Registered Contents].
Compose (Stamp)	Specify whether to print the stamp. If yes, specify settings for "Preset Stamp" or "Registered Stamp", "Print Position", "Fine-Tune", "Color", "Pages", and "Size". To check the registered stamp, click [Confirm Registered Contents]. To use the registered stamp function, stamps must be registered from the control panel in advance.
Stamp Combine Method	Specify the stamp composition method.
Limiting Access to Destinations	Click [Display], and then specify the group that is allowed to access a destination and reference allowed level.

When "No Destination" was selected using [Registration]

Item	Definition
No.	Displays the registration number.
Name	Type in the registration name (up to 24 characters).
Resolution	Specifies the resolution.
File Type	Specify the file format.
File Name	Specify the file name (up to 30 characters).
Page Setting	Specify the unit of data to be saved.
Subject	Specify the E-mail subject. To use the default subject, select "Not Specified". To check the contents of the subject, click [Subject List].
Text	Specify the E-mail text. To use the default subject, select "Not Specified". To check the contents of the subject, click [Text List].
Simplex/Duplex	Specify whether the original is 2-sided.
Original Type	Specify the quality of the original, such as text or photo.
Color	Specify the color mode for scanning.
Separate Scan	Specify whether to divide scanning of the original.
Density	Specify the density.

Item	Definition
Background Removal	Adjust the density of the background.
Scan Size	Specify the original size ("Auto", "Standard Size" or "Custom Size"). If "Standard Size" is selected, select the size and the feed direction. If "Custom Size" is selected, specify the height and width.
Application Setting	Click the [Display] button, and then specify settings for the functions that are displayed.
E-mail Notification	Specify whether to send notification of scan data URL. Specify the notification address for "Address". To select a destination from the list, click [Search from List].
Timer TX	Specify whether to perform timer communication. If yes, enter the transmission time.
Password TX	Specify whether to send the password. If yes, enter the password.
F-Code	Specify whether to send the password using F code. If "Enable" is selected, type in the SUB address and password.
Original Direction	Specify the original orientation.
2-Sided Binding Direction	Specify the binding orientation of the original.
Special Original	Specify the original in a different size.
Book Scan	Specify whether to perform book scan.
Erase	Specify whether to perform frame erase.
Compose (Date/Time)	Specify whether to print the date/time. If yes, specify settings for "Date Type", "Time Type", "Print Position", "Fine-Tune", "Color" "Pages", and "Size".
Compose (Page)	Specify whether to print page numbers. If yes, specify settings for "Page Number", "Chapter", "Print Position", "Fine-Tune", "Color", and "Size".
Compose (Header/Footer)	Specify whether to print a header/footer. If yes, specify the registration number of the header/footer. To check the registered header/footer, click [Confirm Registered Contents].
Compose (Stamp)	Specify whether to print the stamp. If yes, specify settings for "Preset Stamp" or "Registered Stamp", "Print Position", "Fine-Tune", "Color", "Pages", and "Size". To check the registered stamp, click [Confirm Registered Contents]. To use the registered stamp function, stamps must be registered from the control panel in advance.
Stamp Combine Method	Specify the stamp composition method.
Limiting Access to Destinations	Click [Display], and then specify the group that is allowed to access a destination and reference allowed level.

#### 1.48.4 Registering or editing destinations to be temporarily used

Register destinations to be temporarily used or change temporarily used destination settings.



##### Detail

*If "Manual Destination Input" is specified to "Allow", "Temporary One-Touch" is displayed. Specify settings for "Manual Destination Input" from the control panel.*

##### Temporary One-Touch

In Administrator mode of PageScope Web Connection, select the Store Address tab - "Temporary One-Touch".

The settings are the same as the program destination settings. For "Temporary One-Touch", the settings for "Limiting Access to Destinations" are not displayed. For details on settings for "Temporary One-Touch", refer to ["Registering or editing a program destination" on page 1-160](#).

## 1.48.5 Registering E-mail subject or text

Register a subject and text to be used for sending messages or Internet faxes.

### Subject

In Administrator mode of PageScope Web Connection, select the Store Address tab - "Subject" - [Edit]. Specify the following settings.

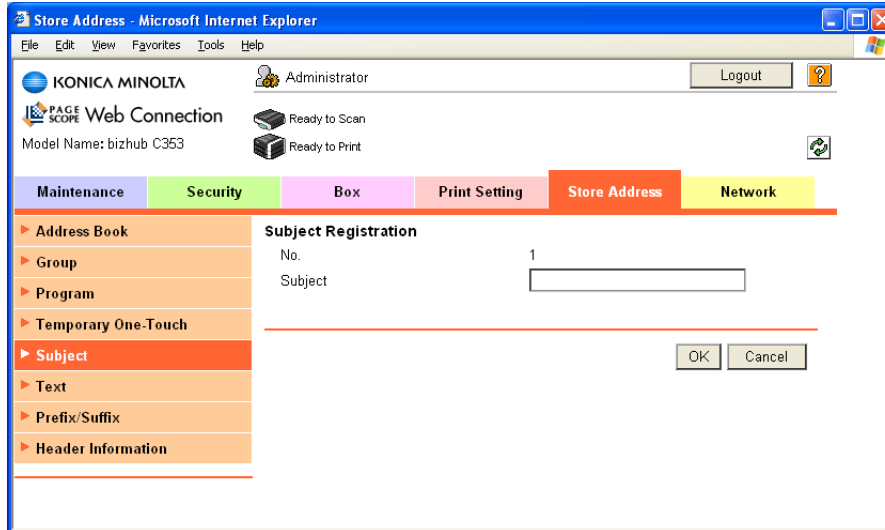

Item	Definition
No.	Displays the registration number.
Subject	Register the E-Mail subject (up to 64 characters).

### Text

In Administrator mode of PageScope Web Connection, select the Store Address tab - "Text" - [Edit]. Specify the following settings.

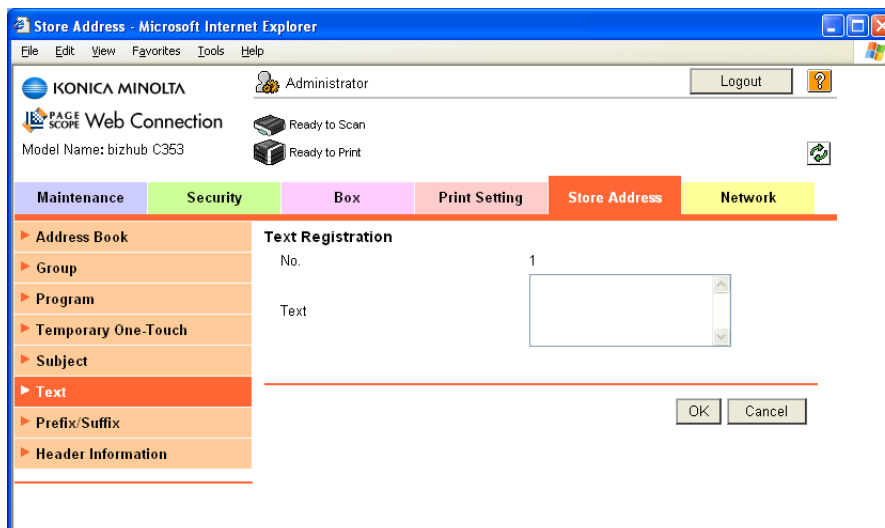

Item	Definition
No.	Displays the registration number.
Text	Register the E-Mail body text (up to 256 characters).

## 1.48.6 Using an application registered in an external server

When using an application, such as RightFax Server, registered with an external server, register the application information and server address.

By registering the application and server, a connection to the server of the selected application can automatically be established for use. Up to five applications and servers can be registered. Depending on settings for registered applications, custom items can be specified. PageScope Web Connection provides the following templates. The templates are provided with pre-determined different custom items by application.



### Detail

*If the optional fax kit has not been installed, "Application Registration" is displayed in the menu.*

*When not using templates, specify custom item settings manually.*

*Only when the optional fax kit is not installed and Internet fax is disabled, the registered applications can be displayed and operated from the control panel of this machine.*

For WalkUp Fax

No.	Button Name	Function Name	Keyboard Type	Default Value	Options
1	Sender Name (CS)	Name	ASCII	Walkup	-
2	Fax Number (CS)	PersonalFaxNumber	ASCII	-	-
3	TEL Number (CS)	PersonalVoiceNumber	ASCII	-	-
4	Subject	Subject	ASCII	-	-
5	BillingCode1	BillingCode1	ASCII	-	-
6	BillingCode2	BillingCode2	ASCII	-	-

For Fax with Account

No.	Button Name	Function Name	Keyboard Type	Default Value	Options
1	Sender Name (CS)	Name	ASCII	-	-
2	User ID	ID	ASCII	Walkup	-
3	Password	Password	ASCII	-	-
4	Password Auth#	Authentication	-	-	None
5	Subject	Subject	ASCII	-	-
6	BillingCode1	BillingCode1	ASCII	-	-
7	BillingCode2	BillingCode2	ASCII	-	-
8	CoverSheet Type	CoverSheet	-	-	-
9	Hold For Preview	HoldForPreview	-	-	False

For Secure Docs

No.	Button Name	Function Name	Keyboard Type	Default Value	Options
1	User ID	ID	ASCII	Walkup	-
2	Password	Password	ASCII	-	-
3	Password Auth#	Authentication	-	-	None
4	Subject	Subject	ASCII	-	-
5	BillingCode1	BillingCode1	ASCII	-	-
6	BillingCode2	BillingCode2	ASCII	-	-
7	CoverSheet Type	CoverSheet	-	-	-
8	Document PW	DocumentPassword	ASCII	-	-
9	Delivery Method	Delivery	-	-	Secure

For Certified Delivery

No.	Button Name	Function Name	Keyboard Type	Default Value	Options
1	User ID	ID	ASCII	Walkup	-
2	Password	Password	ASCII	-	-
3	Password Auth#	Authentication	-	-	None
4	Subject	Subject	ASCII	-	-
5	BillingCode1	BillingCode1	ASCII	-	-
6	BillingCode2	BillingCode2	ASCII	-	-
7	CoverSheet Type	CoverSheet	-	-	-
8	Document PW	DocumentPass- word	ASCII	-	-
9	Delivery Method	Delivery	-	-	Secure

### Application Registration

In Administrator mode of PageScope Web Connection, select the Store Address tab - "Application Registration" - [Registration/Edit].

Select the template type, and then specify the following settings.

The screenshot shows the 'Store Address' configuration page in Microsoft Internet Explorer. The page is titled 'Store Address - Microsoft Internet Explorer' and displays the 'Application Registration' section. The page includes a navigation menu with tabs for Maintenance, Security, Box, Print Setting, Store Address, and Network. The 'Store Address' tab is selected, and the 'Application Registration' section is expanded. The 'Application Setting' section includes fields for 'No.' (1) and 'Application Name'. The 'Server Setting' section includes fields for 'Host Address' (0.0.0.0), 'File Path', 'User ID', 'Password', 'anonymous' (OFF), 'PASV Mode' (OFF), 'Proxy' (OFF), and 'Port No.' (21). The page also features a 'Logout' button and a 'Ready to Scan' indicator.

Item	Definition
No.	Displays the registration number of the selected application.
Application Name	Enter the application name (up to 16 characters).
Host Address	Enter the host address for the server registering the application (up to 15 characters).
File Path	Enter the application file path (up to 96 characters).
User ID	Enter the user ID for logging in to the server (up to 47 characters).
Password	Enter the password for logging in to the server (up to 31 characters).
anonymous	Specify whether even an anonymous user can access the destination.
PASV Mode	Register whether to make communication in the PASV mode.
Proxy	Specifies whether or not a proxy server is used.

Item	Definition
Port No.	Specify the port number to be used.
[Next]	Displays the custom item list. To display the Function Setting screen, click [Edit] for an item to be added or changed.

## Function Settings

Item	Definition
No.	Displays the number of the selected item.
Button Name	Enter the button name (up to 16 characters).
Function Name	Specify the function name.
Message on Panel	Enter the name to be displayed on the panel (32 characters or less).
Display Method	Specify whether to display the name.
Default Value	Enter the default value. To hide the default value, select the "Input string shown as *****" check box. The characters that can be entered differ depending on the selected function.
Keyboard Type	Specify the keyboard type.
Options (When "Authentication" is selected)	Select either "None" or "Password".
Options (When "Delivery" is selected)	Select "Normal", "Secure", "Certified" or "Secure Certified".
Options (When "Hold For Preview" is selected)	Select "Yes" or "No".
Input Type (When "DelaySendData-Time" is selected)	Select "Year/Month/Day/Hour/Minute".
Default (When "DelaySendData-Time" is selected)	Select either "Device Time" or "Not Specify".

## 1.48.7 Simplifying E-mail address entry

To simplify E-mail address entry, register Prefix/Suffix.

### Prefix/Suffix

In Administrator mode of PageScope Web Connection, select the Store Address tab - "Prefix/Suffix" - [Edit].

Specify the following settings.

The screenshot shows a web browser window titled "Store Address - Microsoft Internet Explorer". The page header includes the Konica Minolta logo and "PageScope Web Connection" with the model name "bizhub C353". A navigation bar contains tabs for Maintenance, Security, Box, Print Setting, Store Address (selected), and Network. A left sidebar lists menu items: Address Book, Group, Program, Temporary One-Touch, Subject, Text, Prefix/Suffix (highlighted), and Header Information. The main content area is titled "Prefix/Suffix" and contains three input fields: "No." with the value "1", "Prefix" (empty), and "Suffix" (empty). "OK" and "Cancel" buttons are at the bottom right.

Item	Definition
No.	Displays the registration number.
Prefix	Register the prefix (up to 20 characters).
Suffix	Register the suffix (up to 64 characters).

---



# 2

## Network Settings



## 2 Network Settings

### 2.1 Displaying the Network Settings screen

Settings by purpose can be specified via network settings in the control panel of the machine.

Access network settings from the Administrator Settings screen. Perform the following steps to display the Network Settings screen.

- 1 Press the [Utility/Counter] key.

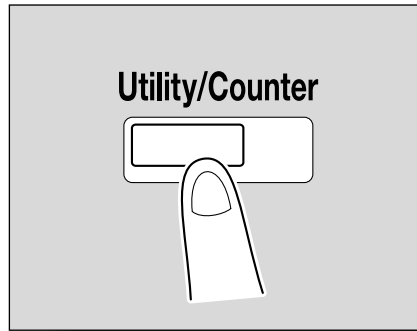

- 2 Touch [3 Administrator Settings].
  - When setting the Utility screen, you can also select a setting by using the keypad to enter the number next to the desired button. To select [3 Administrator Settings], press the [3] key in the keypad.

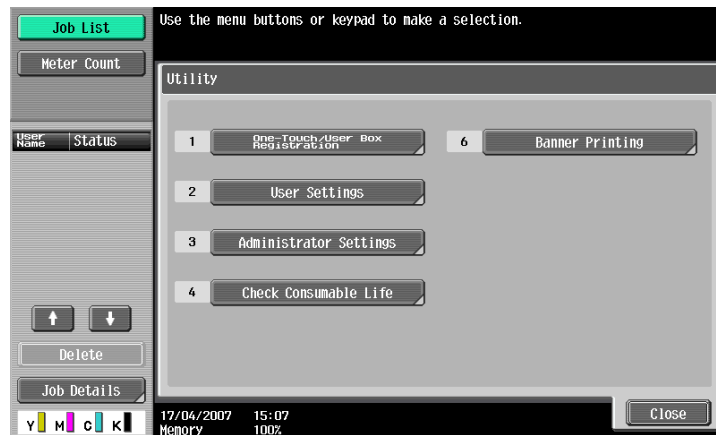

- 3 Type in the password, and then touch [OK].



The Administrator Settings screen appears.

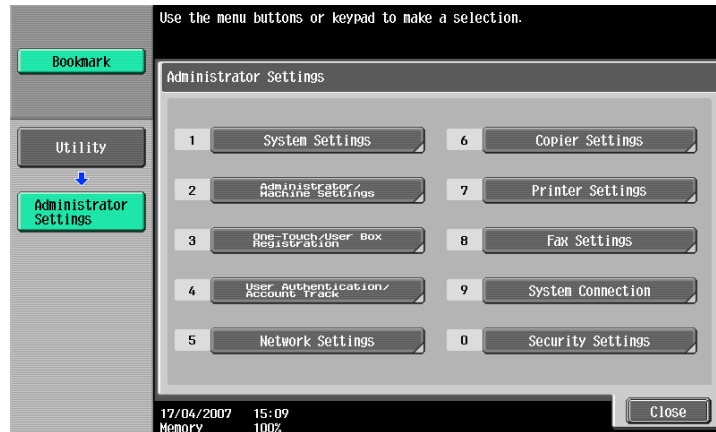

- 4 Touch [5 Network Settings] in the Administrator Settings screen.  
The Network Settings screen appears.

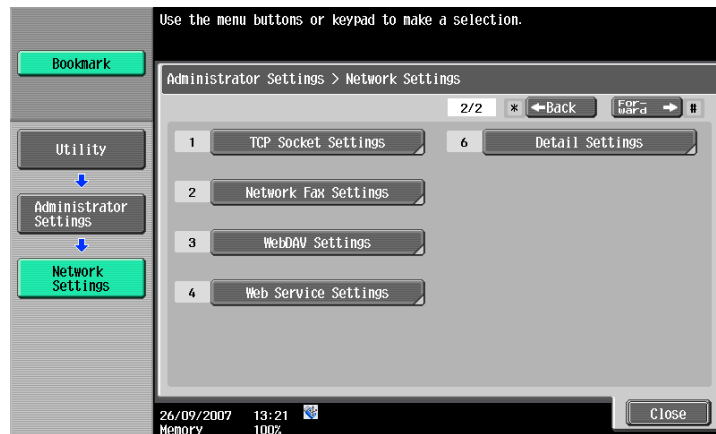
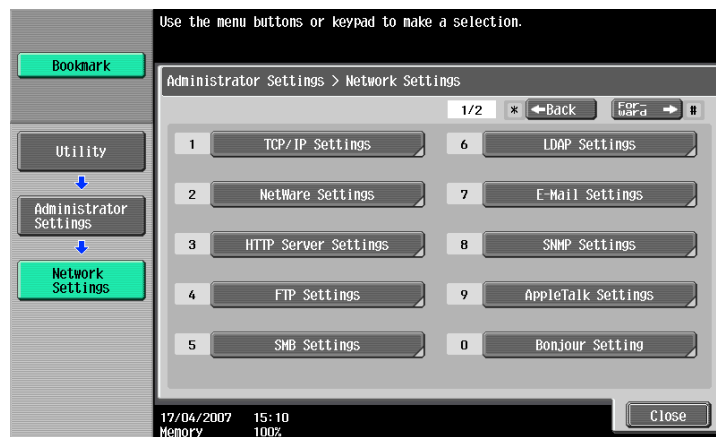

#### Reminder

*In order to apply all changes to the network settings, turn off this machine, then on again.*

*When turning off the main power switch and turning it on again, wait for 10 seconds or longer after power-off, and then turn on the power again. Otherwise, the machine may not operate correctly.*

## 2.2 Network Settings menu list

When specifying settings by purpose from the control panel of the machine, refer to this menu list. This section describes the buttons available when the [5 Network Settings] is touched.



**Note**

For details on displaying the Network Settings screen, refer to "Displaying the Network Settings screen" on page 2-2.

### 2.2.1 Network Settings screen (1/2)

The following setting items are available from the Network Settings screen (1/2).

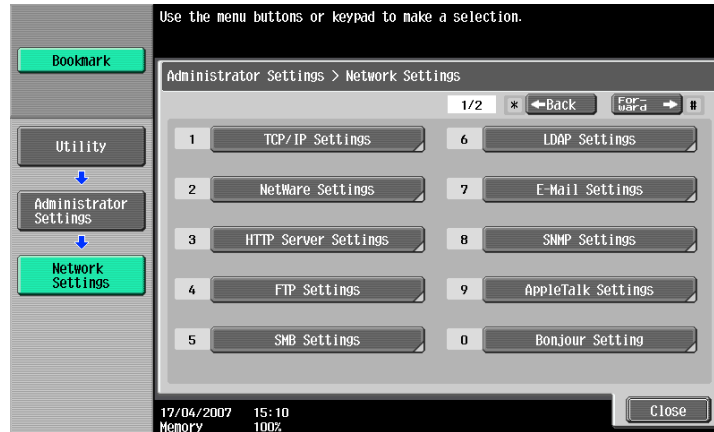

**[1] TCP/IP Settings**

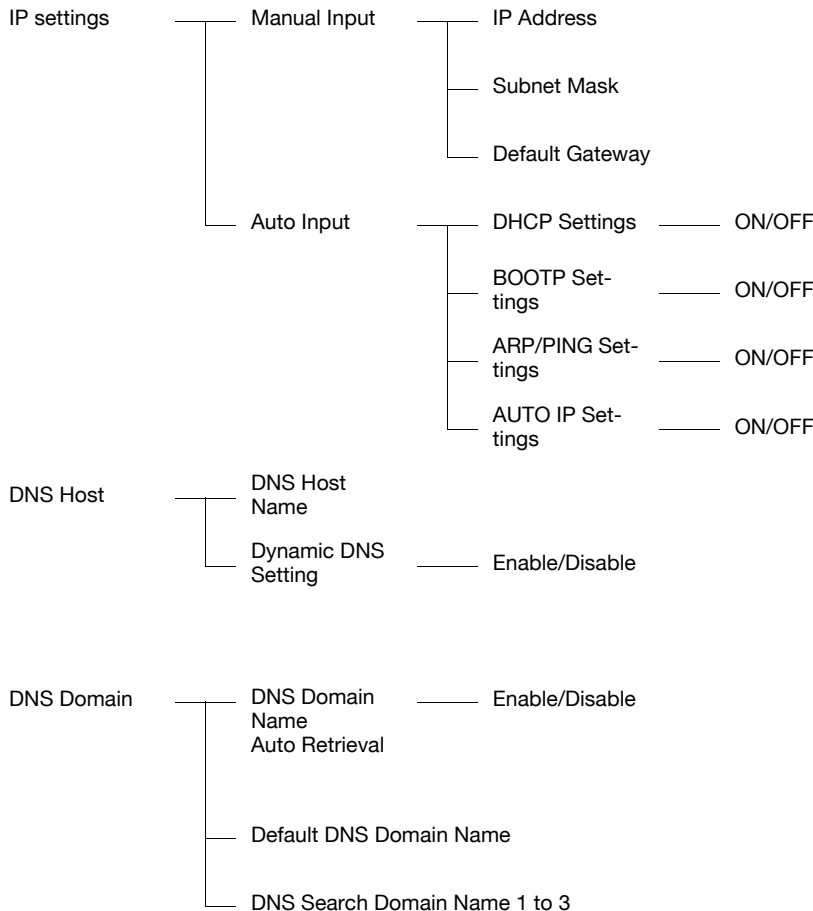

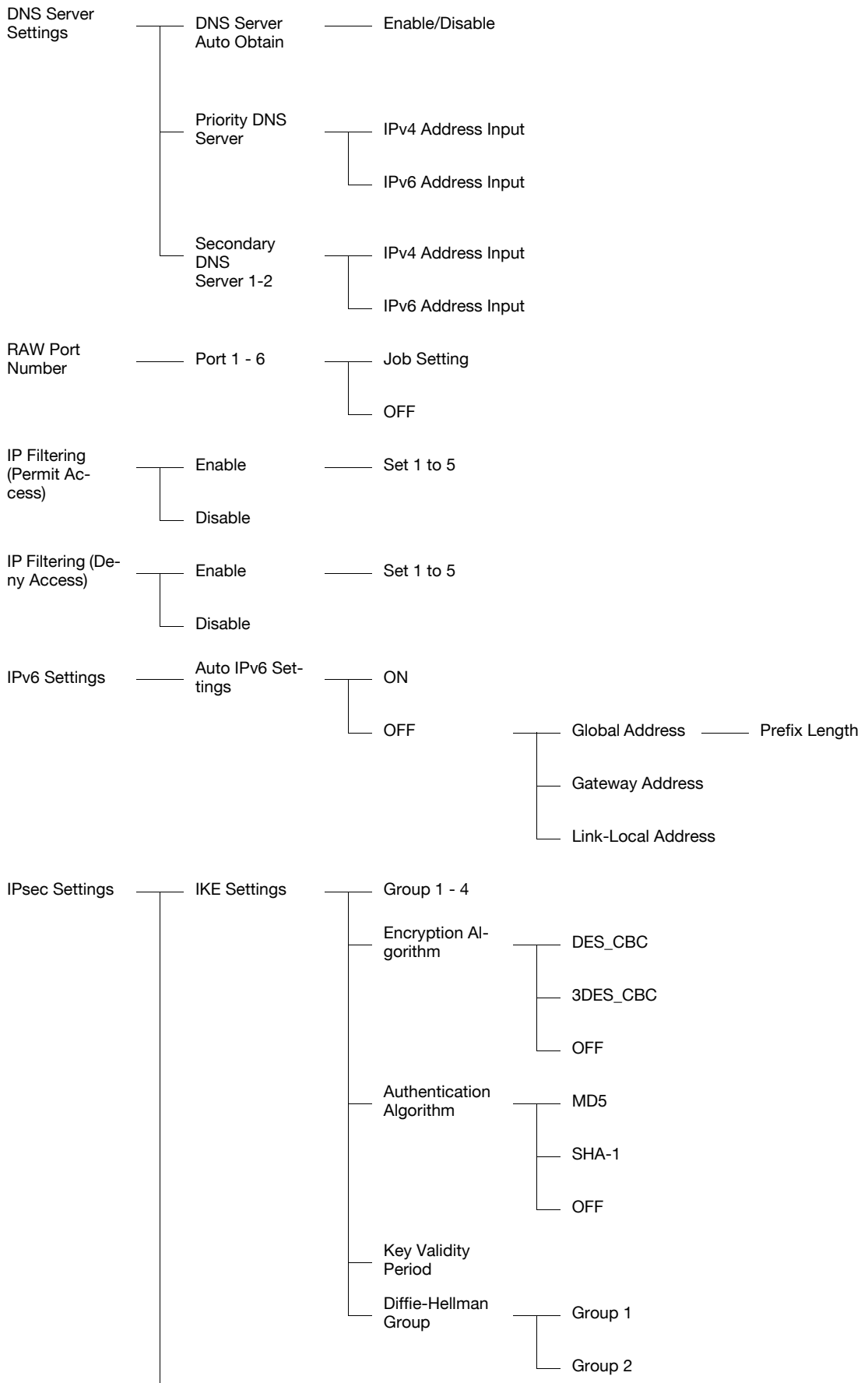

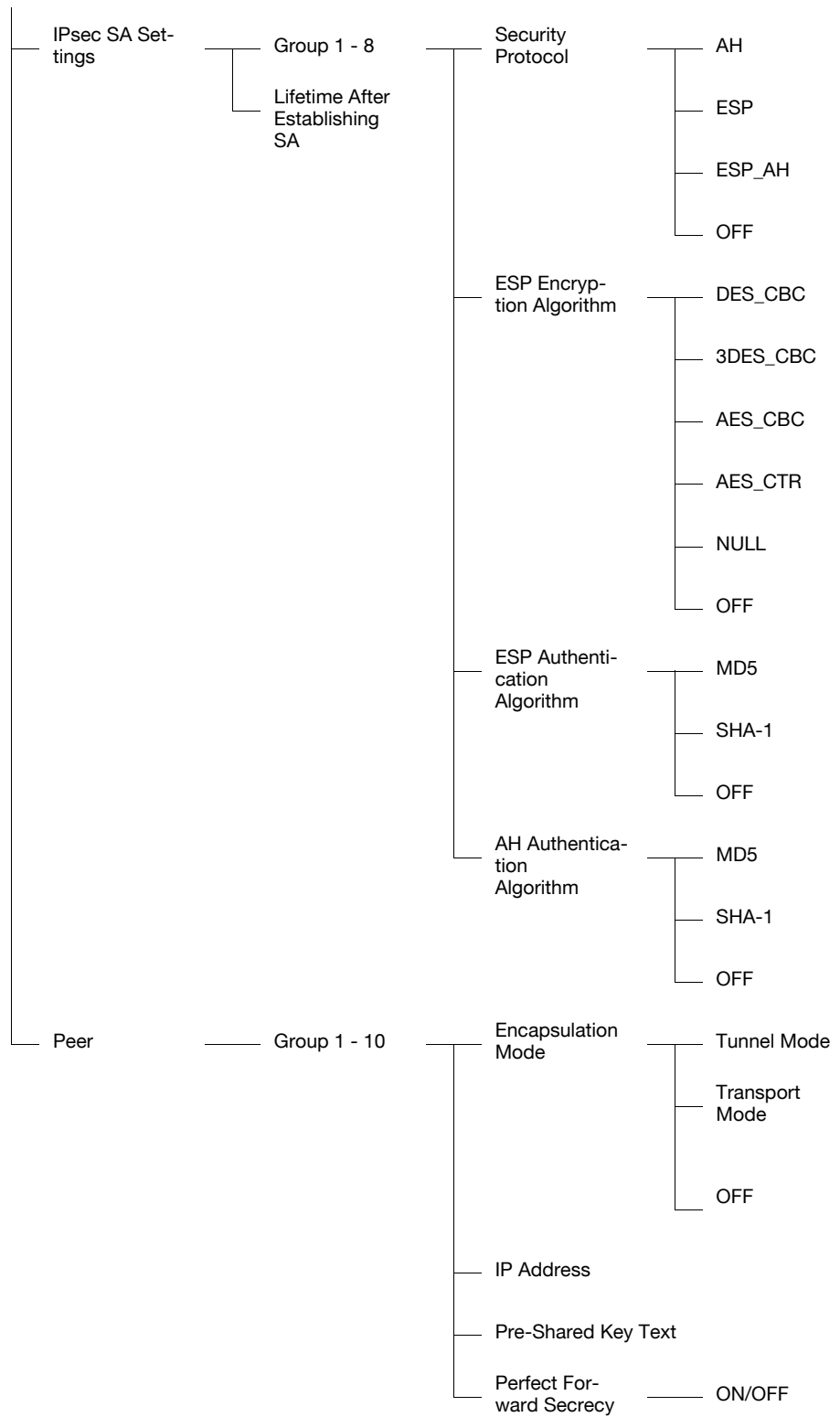

**[2] NetWare Settings**

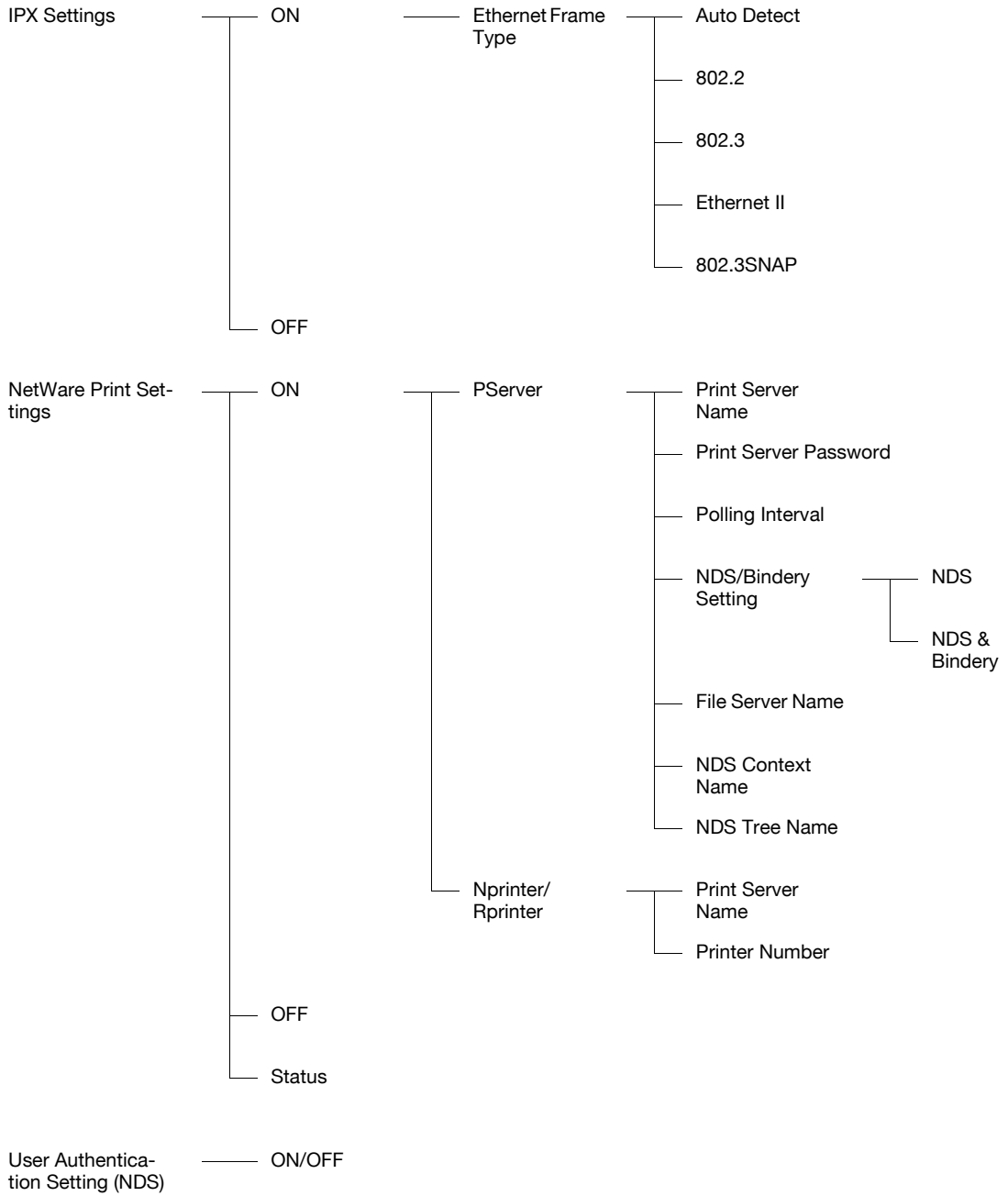

**[3] HTTP Server Settings**

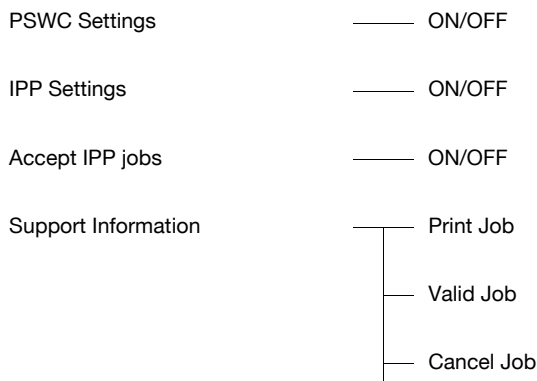

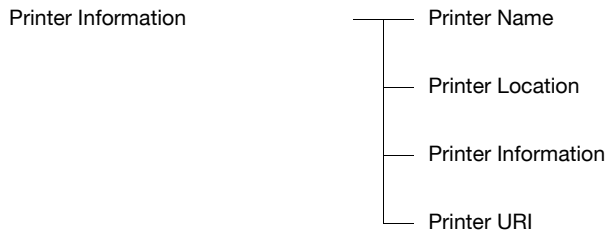
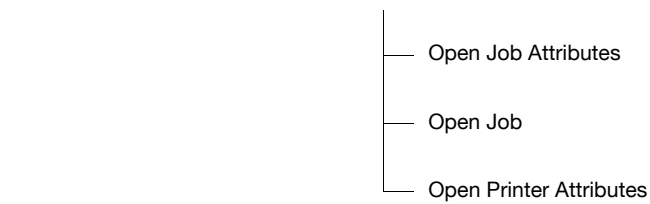

IPP Authentication Settings — ON/OFF

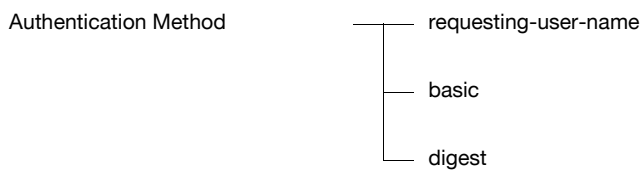

User Name

Password

realm

**[4] FTP Settings**

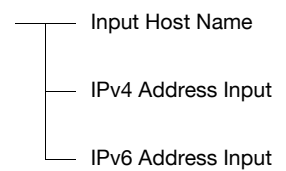
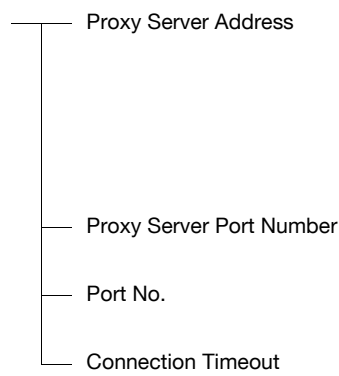
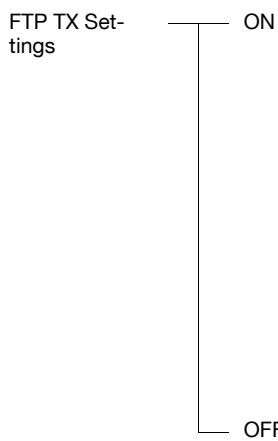

FTP Server Settings — ON/OFF

**[5] SMB Settings**

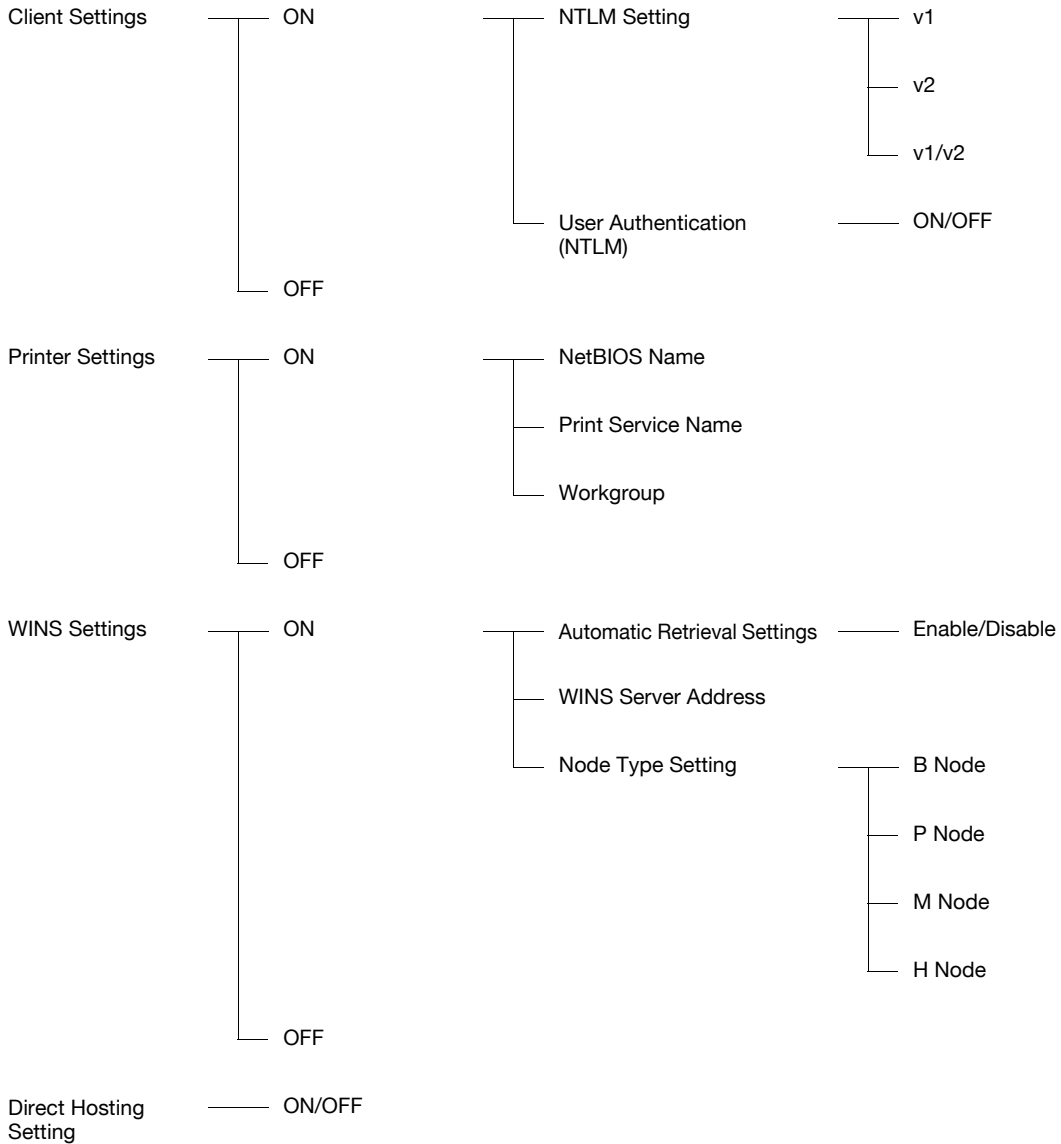

**[6] LDAP Settings**

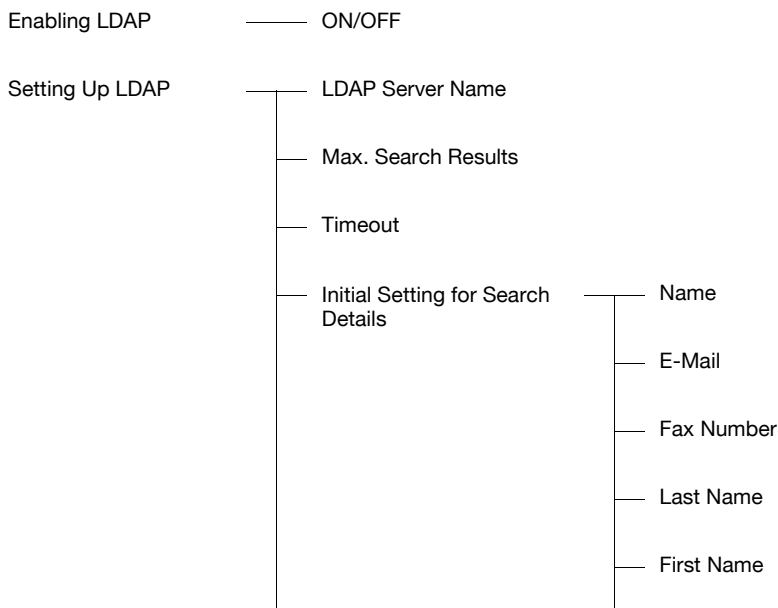



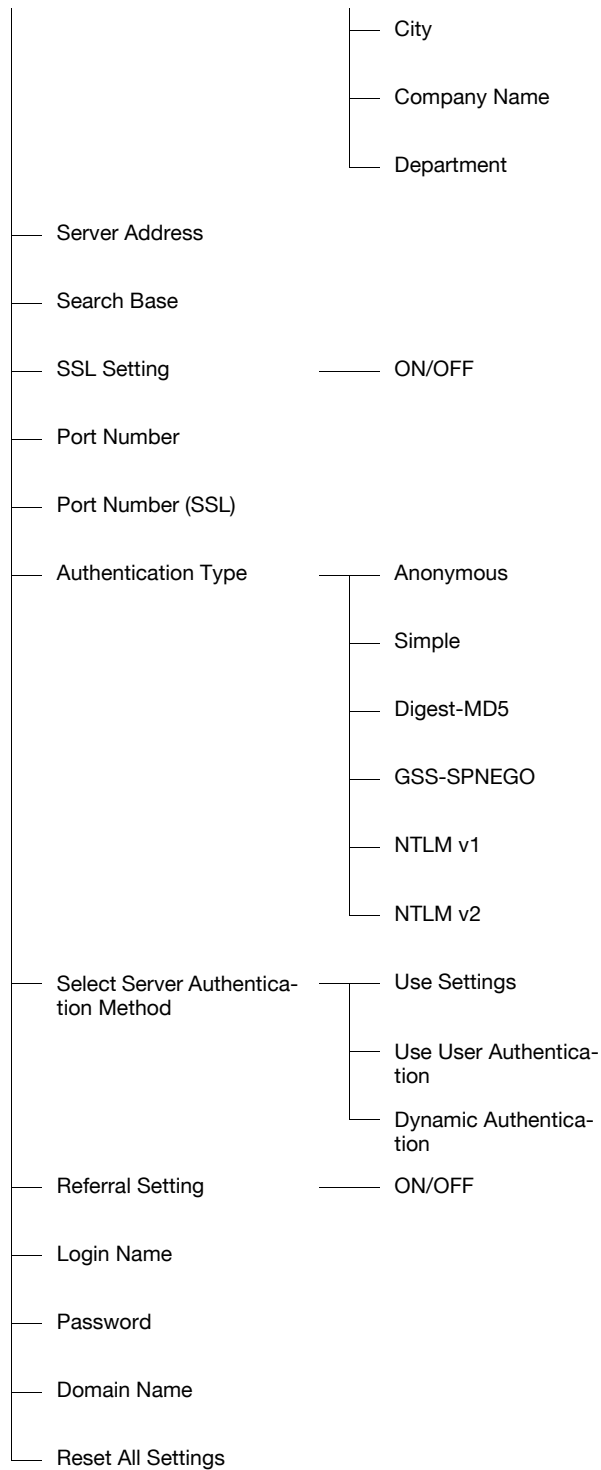

Default LDAP Server Setting

**[7] E-Mail Settings**

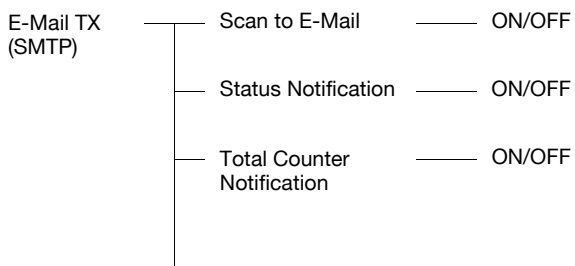

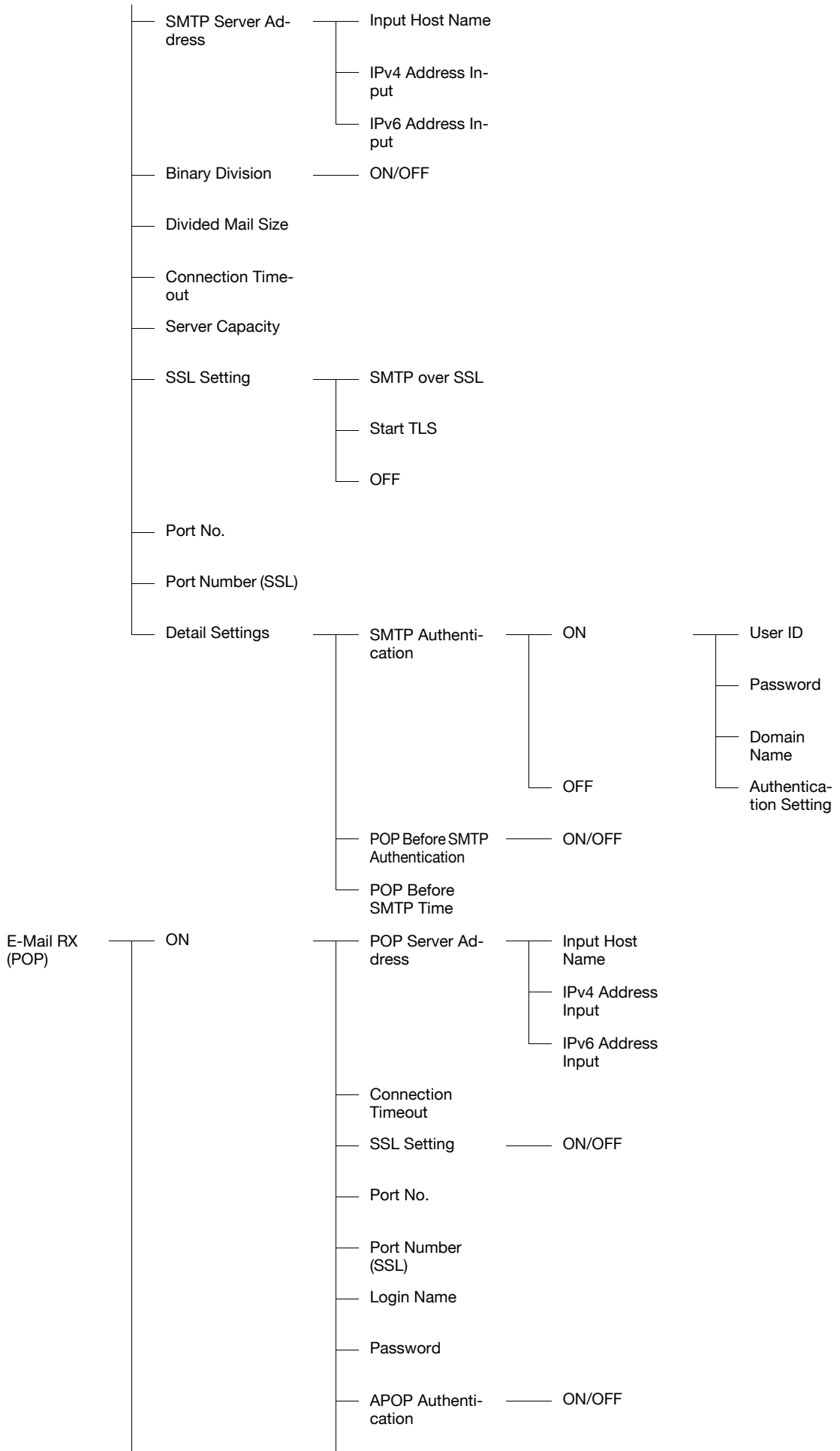

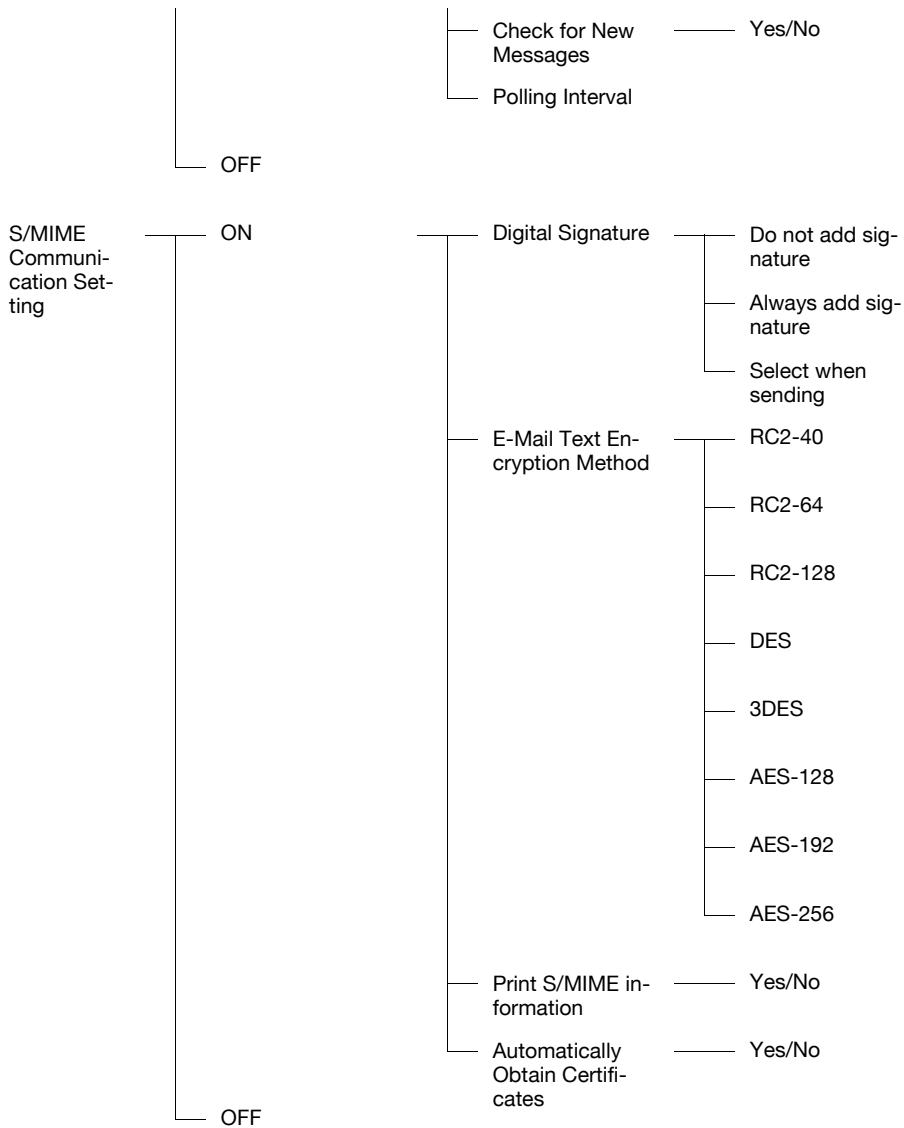

**[8] SNMP Settings**

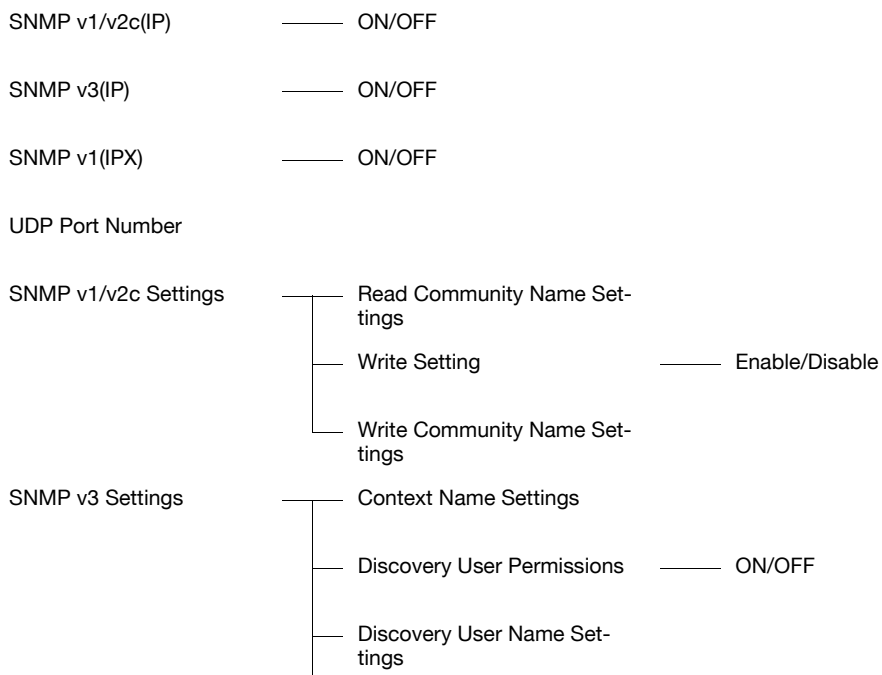

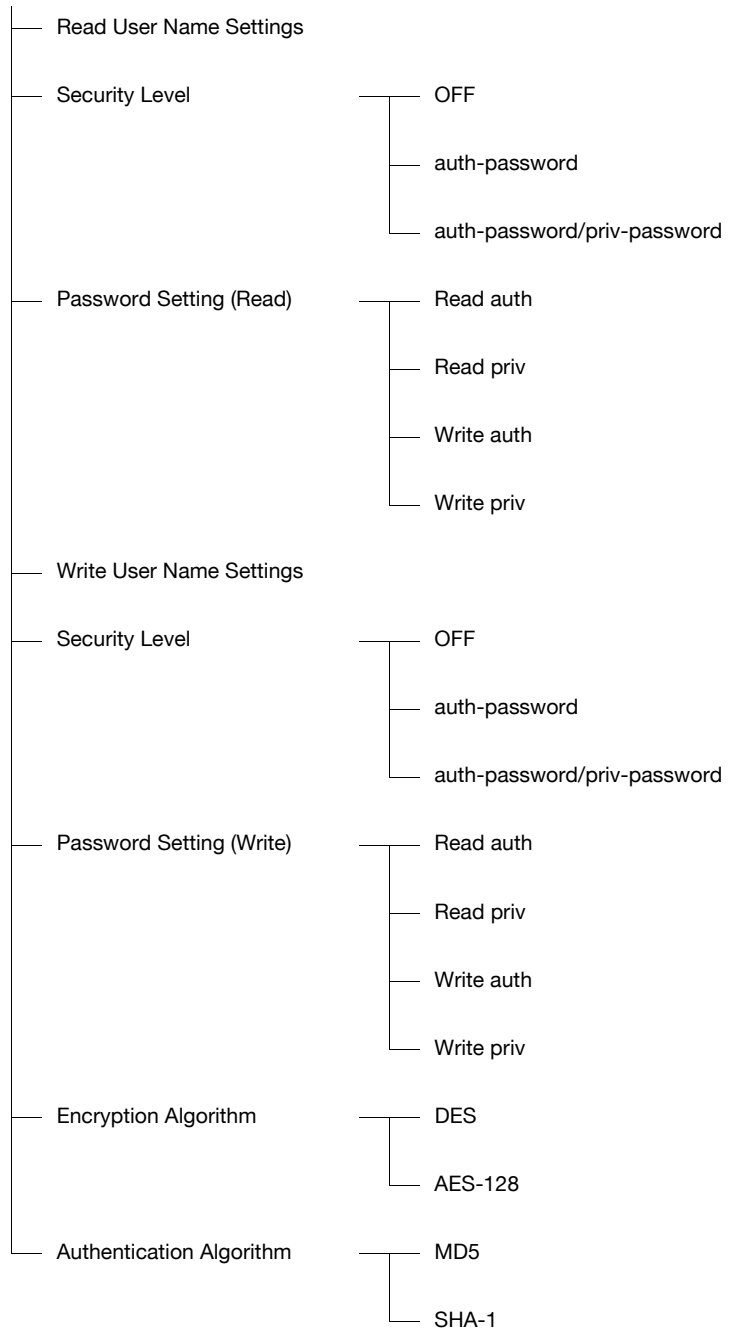

TRAP Setting                    — Allow/Restrict

TRAP Setting When Au-        — Enable/Invalid

thentication Failed

**[9] AppleTalk Settings**

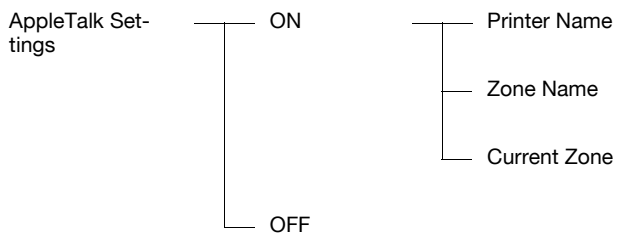

**[0] Bonjour Setting**

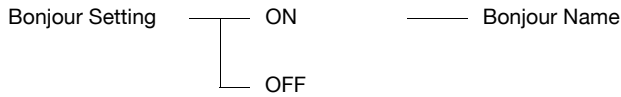

**2.2.2 Network Settings screen (2/2)**

The following setting items are available from the Network Settings screen (2/2).

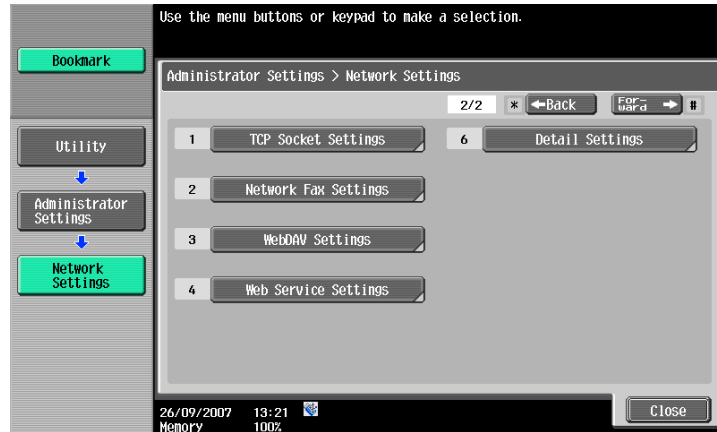

**[1] TCP Socket Settings**

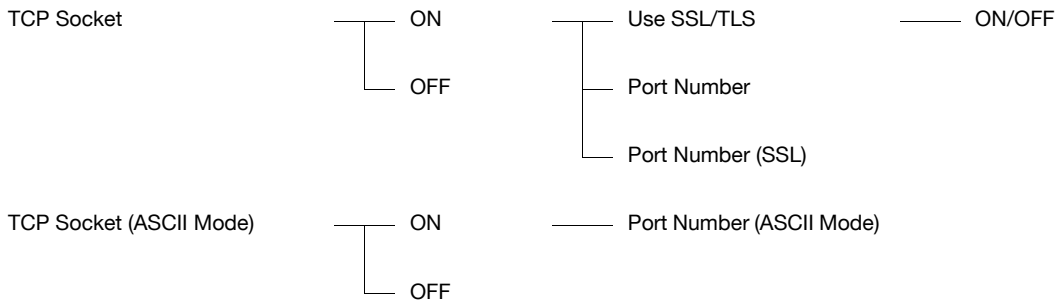

**[2] Network Fax Settings**

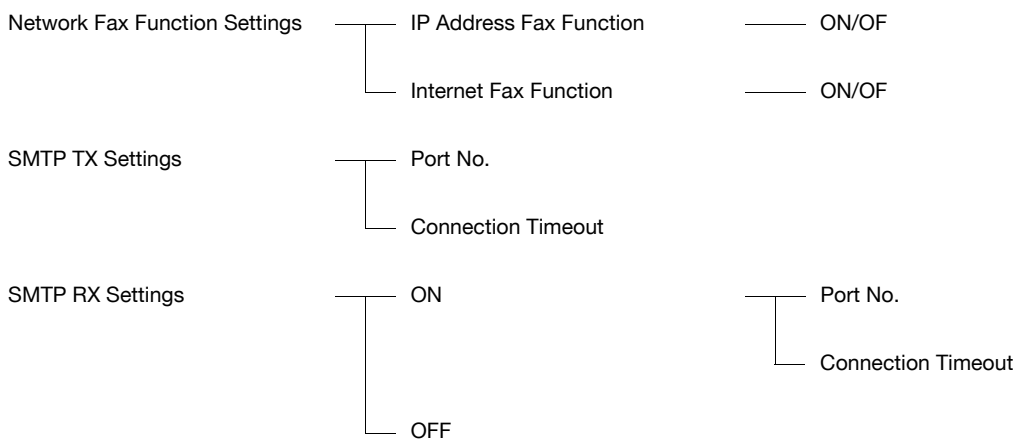

**[3] WebDAV Settings**

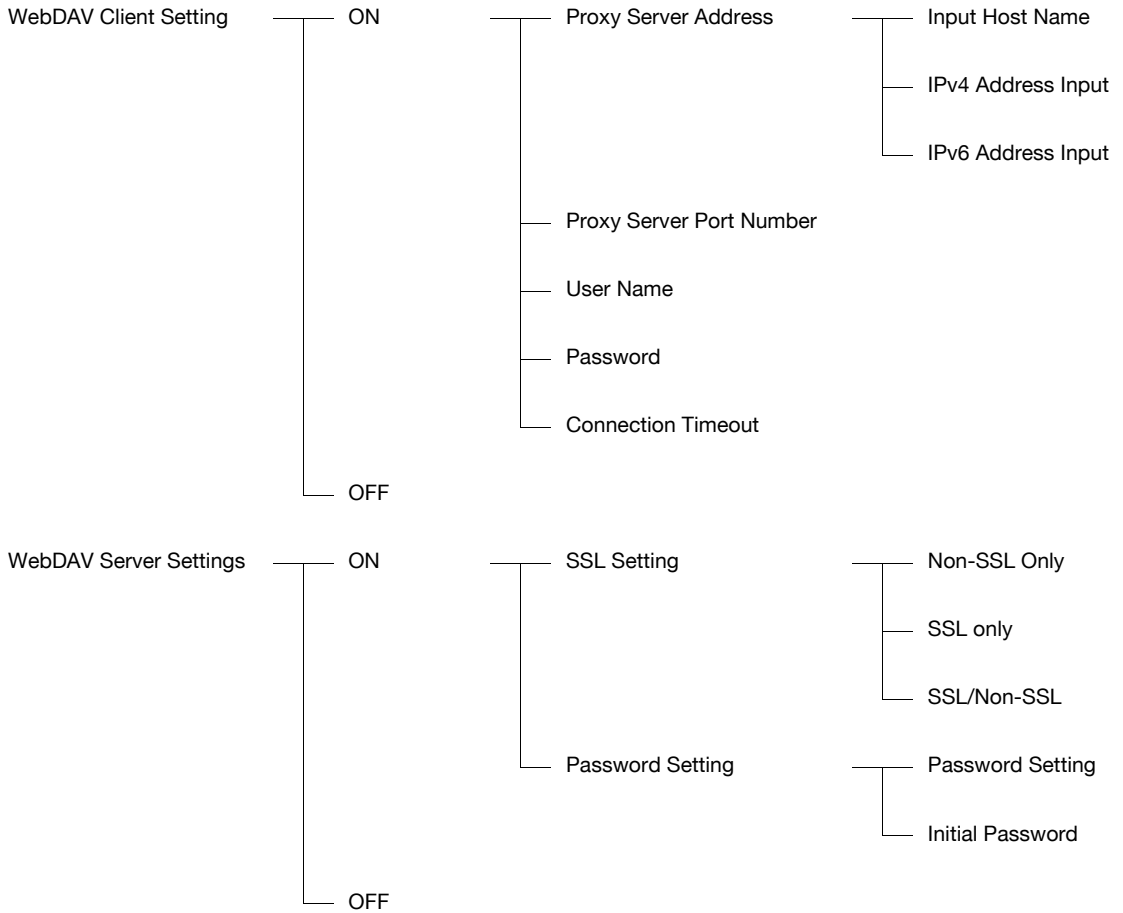

**[4] Web Service Settings**

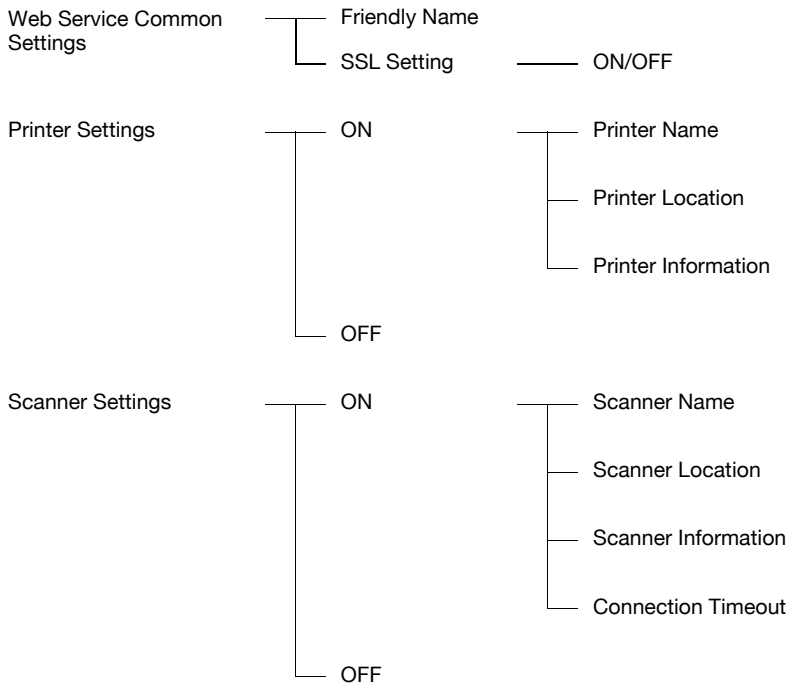

**[6] Detail Settings**

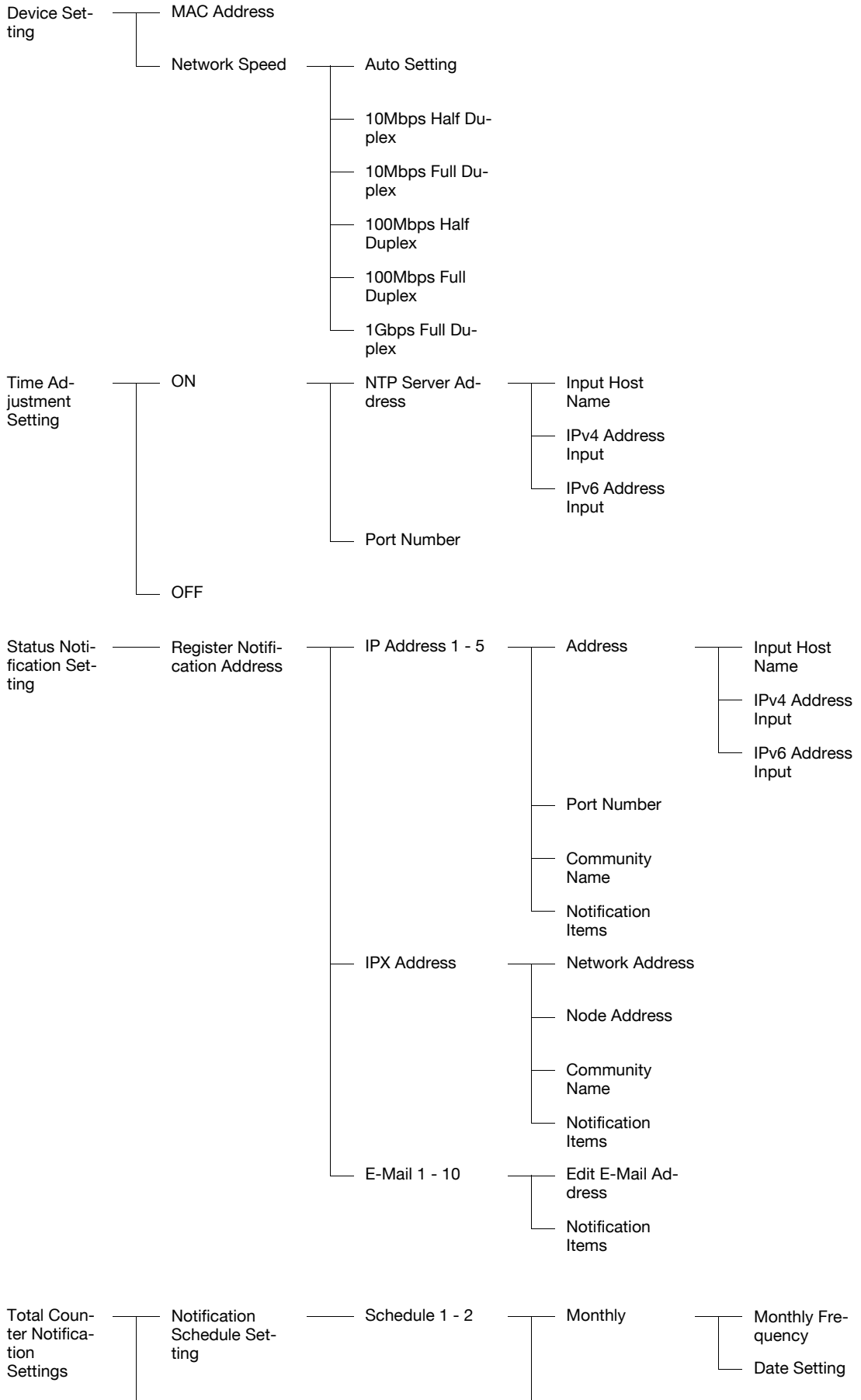

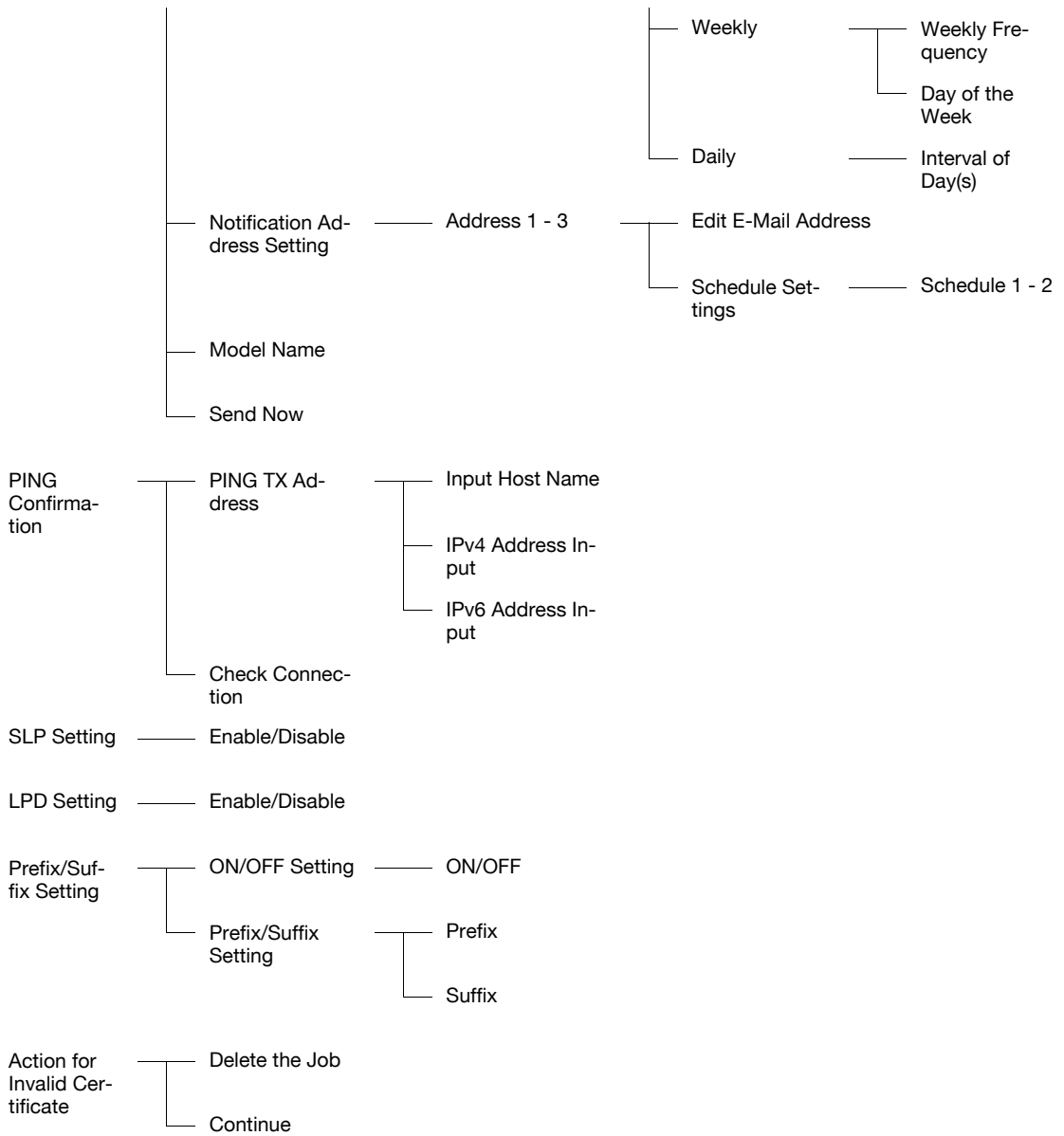



---



# 3

**Appendix**

---

## 3 Appendix

### 3.1 Product Specifications (Network functions)

Item	Specifications
Type	Embedded
Frame type	IEEE802.2/802.3 / Ethernet II / IEEE802.3SNAP
Cable type	10Base-T / 100Base-TX / 1000Base-T
Connector	RJ-45
Mainly supported protocols	TCP/IP (IPv4/IPv6), BOOTP, ARP, ICMP, DHCP, AutoIP, SLP, SNMP, FTP, LPR/LPD, RAW Socket, SMB over TCP/IP, IPP, HTTP, POP, SMTP, LDAP, NTP, SSL, IPX/SPX, AppleTalk, Bonjour, NetBEUI, WebDAV, DPWS, S/MIME, Ipsec, DNS, DynamicDNS
Supported LDAP servers	OpenLDAP 2.1x, Active Directory, Exchange 5.5/2000/2003, Sun Java Directory Server (Netscape/iPlanet Directory Server), Novell NetWare 5.x/6.x NDS, Novell eDirectory 8.6/8.7, LotusDominoServer (5.x/6.x)*
Supported LDAP protocol	LDAP Protocol Version 3 (Version 2 not supported)
Supported SSL versions	SSL2, SSL3, and TLS1.0 (An x.509 certificate must be installed on the server.)
Multiprotocol	Auto detection
Operating environment for PageScope Web Connection	Supported Web browsers: Microsoft Internet Explorer Ver. 6 or later (JavaScript and Cookies enabled) Netscape Navigator Ver. 7.02 or later (JavaScript and Cookies enabled) Mozilla Firefox Ver. 1.0 or later (JavaScript and Cookies enabled) Adobe® Flash® Player (plug-in version 7.0 or later required if "Flash" is selected as the display format)
Setup	Saved to non-volatile memory

\* If you specify the search condition to "OR" or "END" when using the LotusDominoServer, it does not work properly.

## 3.2 Glossary

Term	Description
10Base-T/ 10B100Base-TX/ 1000Base-T	A set specifications under the Ethernet standards. Uses cables consisting of pairs of twisted copper wires. The transmission speed of 10Base-T is 10 Mbps, of 100Base-TX is 100 Mbps, and of 1000Base-T is 1,000 Mbps.
2in1	This is a function to send the page set as double page by consolidating the two-page document on one sheet of paper.
Abbreviation/ address	This is a function to register the frequently used fax number of the recipient. When registering abbreviation/address, you can register the address name and search characters. It makes possible to specify the address using the searched character of the abbreviated selection.
Active directory	A service that consolidates management of all information such as hardware resources for servers, clients, and printers on a network supported by Microsoft and the attributes and access permissions of the users.
Adobe® Flash®	Software developed by Adobe Systems Inc. (formerly developed by Macromedia, Inc.), and used to create data combining vector-graphic animation and sound, and the format of this data file. The bidirectional content can be manipulated using a keyboard and a mouse. The files can be kept relatively compact, and they can be accessed with the Web browser plug-in.
anonymous FTP	While normal FTP sites are protected by an account name and password, this type of FTP site can be used by anyone without a password by simply entering "anonymous" as the account name.
APOP	Abbreviation for Authenticated Post Office Protocol. An authentication method with encrypted passwords, which results in increased safety, as compared to the usual unencrypted passwords used by POP to retrieve e-mail messages.
AppleTalk	A generic name for the protocol suite developed by Apple Computer for computer networking.
Auto IP	A function for automatically acquiring the IP address. If acquisition of the IP address failed with DHCP, an IP address is acquired from the address space of 169.254.0.0.
Background Removal	This function sends a document after adjusting brightness of the background color of the document.
Batch transmission	This is a function automatically sends one document at a specified time, only when the transmission conditions such as destination, sending time, memory transmission or resolution are stored in the same document memory.
Binding Position	This is a function for specifying the binding position of a double-sided document sent using the ADF. There is top/bottom binding, where the binding position is at the top (or) bottom of the document, and there is left/right binding, where the binding position is at the left (or right) of the document and the top and bottom of the second side of the document differ.
bit	Abbreviation for Binary Digit. The smallest unit of information (data quantity) on a computer or printer. Displays data using 0 or 1.
Bitmap Font	A font that is displayed using a collection of dots. These look increasingly jagged with larger font sizes.
Blocked number	This is a function to avoid receiving of the troublesome fax by registering the number you want to block in advance. If a registered telephone number matches the receiving telephone number, the incoming call is rejected and a [Blocked] message is displayed.
BMP	Abbreviation for Bitmap. A file format for saving image data which uses the .bmp extension. Commonly used on Windows platforms. You can specify the color depth from monochrome (2 values) to full color (16,777,216 colors). Images are not usually compressed when saved.
Bonjour	Macintosh network technology for automatically detecting devices connected to the network and for specifying settings. Previously called "Rendezvous", the name was changed to "Bonjour" starting with Mac OS X v10.4.
Book Copy	A function for sending a fax of a book or catalog with the front cover, back cover and the left and right pages sent as separate pages.
BOOTP	Abbreviation for Bootstrap Protocol. A protocol in which a client computer on a TCP/IP network automatically specifies the network settings from the server. Currently, DHCP, which is an advanced protocol based on BOOTP, is mainly used.
bps	This is an abbreviation of bit per second. It means the amount of data sent in one second as the unit of data transmission.

Term	Description
Brightness	Brightness of a display screen.
Broadcast	A transmission of a single document to many recipients in one operation.
Bulletin board	This function posts the documents to be viewed, or stores the documents to be transmitted through polling.
Byte	Unit of information (data quantity) on a computer or printer. Configured as 1 byte equals 8 bits.
Check Dest. & Send	A function for sending a fax transmission only after the specified fax number and the fax number information (CSI) for the recipient's machine match. This prevents misdirected transmissions since a transmission error occurs if the numbers do not match.
Client	A computer that uses the services provided by a server through a network.
Closed Network RX	A function for accepting only transmissions from recipient machines with a matching password.
CMYK	Abbreviation for Cyan, Magenta, Yellow, and Black. The toner and ink colors used for color printing and all colors can be represented by changing the mixing ratio of CMYK.
Color matching	Technology for minimizing color discrepancy among different devices such as scanners, displays, and printers.
Compact PDF	A compression method for reducing the data amount using the PDF format when converting color documents to data. The highest compression efficiency is achieved by identifying the text and image regions and using the resolution and compression method most appropriate for each region. The compact PDF format can be selected when converting documents to data using the scanning functions of this machine.
Confidential communication	A function for sending and receiving documents to be viewed only by specific persons. The confidential document is saved in a confidential box in the recipient's machine and is not printed when it is received. The received document can be printed when a specific operation is performed, for example, when the access code for the confidential box is entered.
Contrast	The difference in intensity between the light and dark parts of the image (light/dark variation). An image with small light/dark variation has low contrast, and an image with large light/dark variation has high contrast.
CSV	Abbreviation for Comma Separated Values. One of the formats for saving database or spreadsheet data as a text file. (The file extension is ".csv".) The data, which is separated by commas (as the delimiter), can be shared by different applications.
Default	The initial settings. The settings first selected when the machine is turned on, or the settings first specified when the function is selected.
Default gateway	A device, such as a computer or router, used as a gateway to access computers not on the same LAN.
Default value	The setting value specified in advance when the machine is shipped from the factory. Some default settings can be changed from the settings menu. It is convenient to set frequently used values as default settings based on the usage conditions.
Density	An indication of the amount of darkness in the image.
Density Compensation	Color correction function used in output devices such as printers and displays.
DHCP	Abbreviation for Dynamic Host Configuration Protocol. A protocol in which a client computer on a TCP/IP network automatically specifies the network settings from the server. With collective management of the IP address for DHCP clients on the DHCP server, you can avoid duplication of an address and build a network easily.
Dialing method	There are three types: PB (push-button (tone) dialing), 10PPS (pulse dialing at 10 pps), and 20PPS (pulse dialing at 20 pps).
Direct Inward Dialing (DID)	A function that provides numbers for fax and phone functions separately. In order to use the DID function, one must subscribe for NTT's DID (modem DID) services.
Dither	One method of combining two colors to create an approximate representation of shades of gray. Processing is easier than with error diffusion, but this can lead to irregularities.
DNS	Abbreviation for Domain Name System. A system that acquires the supported IP addresses from host names in a network environment. DNS allows the user to access other computers over a network by specifying host names, instead of having to use IP addresses that are difficult to remember and complicated.

Term	Description
DPI (dpi)	Abbreviation for Dots Per Inch. A resolution unit used by printers and scanners. Indicates how many dots per inch are represented in an image. The higher the value, the higher the resolution.
Driver	Software that works as a bridge between a computer and a peripheral device.
DSN	Abbreviation for Delivery Status Notifications. A delivery status notification message that is sent back to the sender at the time the E-mail is received at the recipients mail server.
Dynamic authentication (LDAP setting)	An authentication method option for connecting to the LDAP server from the multi-functional product. Select this option if the name and password for logging on to the LDAP server must be entered each time by the user when referencing the destination information from the LDAP server.
ECM	Abbreviation for Error Correction Mode. Error resend mode of G3 communication. It confirms whether the data is correctly sent to the recipient or not, and if it is not correctly sent, it communicates by resending the same data. If the recipient is set for the ECM mode and the communication is done in ECM unless ECM off is specified in this machine.
Ethernet	LAN transmission line standard.
Fax ID	The identifying code for the mutual recognition when transmitting faxes. Normally the fax number is registered as the fax ID.
File extension	The characters added to the file name in order to identify file formats. The file extension is added after a period, for example, ".bmp" or ".jpg".
Forced memory reception	This is the function to store the received document in memory and to print if required.
Frame Erase	This is a function to erase the black shadow around the document and then transmit the fax, for example, when scanning the document formed of booklet or when scanning a document by keeping ADF open.
Frame type	Type of communication format used in a NetWare environment. Communication is not possible if the same frame type is not used.
FTP	Abbreviation for File Transfer Protocol. A protocol for transferring files over the Internet or an intranet on the TCP/IP network.
F code	This is a communication procedure for the usage of sub address of T.30* standardized by ITU-T (international telecommunication union) provided by Japanese Communications Industrial Corporation. In the communication between fax machines with the F code function, various functions that use F code can be utilized even if the manufacturers of the fax machines are different. In this machine, F code is used in the bulletin boards, relay request, relay transmissions, confidential communication, and password transmission. (*Communication standard)
G3	This is a fax communication mode standardized by the ITU-T (International Telecommunication Union). The communication modes are G3 and G4. G3 is currently the most popularly used mode.
Gateway	Hardware and software used as the point where a network is connected to a network. A gateway also changes data formats, addresses, and protocols according to the connected network.
Gradation	The light and dark levels of an image. As the number increases, smoother brightness variations can be reproduced.
Gray Scale	Monochrome image expressed with black and white gradation information.
Group	Grouping of the abbreviation No. of multiple groups. This function is useful when there is a large number sequential broadcast and sequential polling received in the same address.
GSS-SPNEGO/ Simple/Digest MD5	Authentication methods for logging on to the LDAP server. The authentication method (GSS-SPENGO, SIMPLE or Digest MD5) for the LDAP server differs depending on the server being used and the server settings.
Halftone	The method of producing the light and dark parts of an image through varying sizes of black and white dots.
Hard disk	Large capacity storage device for storing data. The data can be stored even if the power is turned off.
Host name	Displayed name of a device over a network.
HTTP	Abbreviation for HyperText Transfer Protocol. A protocol used to send and receive data between a Web server and a client (Web browser). Documents containing images, recordings, or video clips can be exchanged with the expressive form information.

Term	Description
ICM	Abbreviation for Image Color Management. The color management system used by Windows. Color differences of input/output devices, such as monitors, scanners and printers, are adjusted to reproduce colors so that they are nearly the same on any device.
Install	To install hardware, operating systems, applications, printer drivers on to a computer.
Internet Fax	Transmission method by which scanned documents are sent and received between an Internet fax and computers as TIFF format E-Mail attachments over intranets (internal company networks) and the Internet.
IPP	Abbreviation for Internet Printing Protocol. A protocol that sends and receives print data and controls printers over a TCP/IP network such as the Internet. Data can also be sent to printers in remote areas to be printed over the Internet.
IPsec	The security technology that is used with TCP/IP. A service with enhanced security can be provided by specifying the encryption of transmission packets and the authentication protocol.
IPv6	Abbreviation for Internet Protocol version 6. A protocol that has been prepared to replace the currently used IPv4 protocol in response to increase in the number of devices that use the Internet. Additional improvements include 128-bit IP addresses and added security features.
IPX	One of protocols used with NetWare. Operates at the network layer of the OSI reference model.
IPX/SPX	Abbreviation for Internetwork Packet Exchange/Sequenced Packet Exchange. A protocol developed by Novel, Inc. that is commonly used under a NetWare environment.
IP Address	A code (address) that is used to identify individual network devices over the Internet. IPv4 (Internet Protocol version 4), widely spread today, is expressed such as 192.168.1.10 using 32-bit numbers divided into four. In the next generation IPv6 (Internet Protocol version 6), 128-bit IP addresses are used. IP addresses are assigned to devices, including computers, which are connected to the Internet.
IP Address Fax	An IP address identifies various networked devices on the Internet. IP Address Fax uses these addresses to transmit and receive faxes within an intranet.
JPEG	Abbreviation for Joint Photographic Experts Group. One of the file formats for saving image data. (The file extension is ".jpg"). The compression ratio is approximately 1/10 to 1/100. This format uses an effective method in the compression of continuous-tone images, such as photographs.
Kerberos	A type of network authentication system used by Windows 2000 or later. Used in Active Directory authentication. Users can be safely and efficiently authenticated with a two-phase authentication (user logon and network resource usage) on a dependable site set up on the network.
LAN	Abbreviation for Local Area Network. A network which connects computers on the same floor, in the same building, or in neighboring buildings.
Local line	Public telephone line supported by Nippon Telegraph and Telephone Corporation.
Local printer	A printer connected to a parallel or USB port of a computer.
Long Document	A setting for sending document pages longer than A3 size (420 mm/16-1/2 inches). Long documents can be transmitted by specifying the setting for long originals.
LPD	Abbreviation for Line Printer Daemon. A printer protocol that uses TCP/IP and is platform-independent. LPD was originally developed for BSD UNIX, and it has become the standard printing protocol that can be used with any computers.
LPR/LPD	Abbreviation for Line Printer Request/Line Printer Daemon. A printing method over a network in a Windows NT system or UNIX system. Using TCP/IP, you can output print data from Windows or Unix to a printer over a network.
LDAP	Abbreviation for Lightweight Directory Access Protocol. On a TCP/IP network, such as the Internet or an intranet, this protocol is used to access a database for managing environment information and the E-Mail addresses of network users.
MAC address	Abbreviation for Media Access Control address. With a special ID number for each Ethernet card, data can be sent and received between the cards. This number consists of 48 bits. The first 24 bits consist of a number that represents a manufacture, which is controlled and assigned by IEEE. The last 24 bits consist of a number that the manufacturer assigns uniquely to the card.
Main scanning	The operation of optically scanning the document and converting it to image data.
Main scanning direction	This is the horizontal direction of scanned documents.
Manual transmission	An operation to send a fax while checking the status of the receiving machine.

Term	Description
Memory	Storage device for storing data temporarily. When the power is turned off the data may or may not be erased.
Memory overflow	A condition where the fax memory becomes full while scanned documents or temporarily stored documents are saved.
Memory transmission	This is a procedure for starting a fax transmission after a document is scanned and stored in the memory. If memory transmission is used, the total number of pages are automatically printed in the page number of the transmission source information and an image of the first page of the sent document is printed in the transmission report. However, the memory may become full if there are many pages of the document or if the data is large due to finely detailed images.
MDN	Abbreviation for Message Disposition Notifications. A delivery confirmation message that is sent back to the sender in response to such as request.
MH	Abbreviation for Modified Huffman. A data compression encoding method for fax transmissions. Documents containing mostly text are compressed to about 1/10 their original size.
MIB	Abbreviation for Management Information Base. In a TCP/IP transmission, MIB uses SNMP to define the management information format for a group of network devices. There are two formats: the manufacturer-specific private MIB and the standardized MIB.
Mixed Original	This is a function to detect and send various sizes of documents.
MMR	Abbreviation for Modified Modified Read. A data compression encoding method for fax transmissions. Documents containing mostly text are compressed to about 1/20 their original size.
Multi Page TIFF	A TIFF file that has multiple pages.
NDPS	Abbreviation for Novell Distributed Print Services. Provides a highly efficient printing solution in an NDS environment. By using the NDPS as a printer server, you can output from the desired printer, automatically download the printer driver of a newly installed printer, simplify and automate complicated management environments related to printer use, and integrate management related to the network printer.
NDS	Abbreviation for Novell Directory Services. The servers and printers on a network and the shared resources of the user information, as well as the user access authority over these items can be consolidated in the hierarchic structure.
NetBIOS	Abbreviation for Network Basic Input Output System. A communication interface developed by IBM.
NetBEUI	Abbreviation for NetBIOS Extended User Interface. A network protocol developed by IBM. By simply specifying the computer name, you can build a small-scale network.
NetWare	Network operating system developed by Novell. NetWare IPX/SPX is used as the communication protocol.
No. of documents	Used for quick memory transmission to send a fax transmission with the total page numbers. This function allows the recipient to check whether all pages were received or not (In case of memory transmission, the total no. of pages are automatically added).
Nprinter/Rprinter	Remote printer support module for using a printer server under a NetWare environment. Use NetWare 3.x with Rprinter, and NetWare 4.x with Nprinter.
NTLM	Abbreviation for NT LAN Manager. User authentication method used by Windows NT or later. With the MD4 and MD5 encoding methods, passwords are encoded.
NTP	Abbreviation for Network Time Protocol. The protocol for correctly adjusting the internal clock of the computer over the network. In a hierarchical method, the time is adjusted with the server at the highest level using GPS to acquire the correct time, which is then referenced by each lower level host.
OCR	Abbreviation for Optical Character Reader. A device or software that converts handwritten or printed documents to text data by optically scanning it and, through comparison with a previously stored pattern, identifies the characters.
OHP/OHT	Transparent sheet used for OHP (overhead projector). Used for a presentation, etc.
OS	Abbreviation for Operating System. Basic software for controlling the system of a computer. Windows, MacOS, and Unix are Operating Systems.
Outline font	A font using lines and curves to display an outline of a character. Large-size characters can be displayed on a screen or printed with no jagged edges.

Term	Description
Overseas communication	This is a function to communicate with an overseas recipient. If an overseas communication mode is set, the fax transmission is sent with a lower speed. Specifying an overseas transmission mode ensures the fax transmission is sent when faxing to the location where transmission conditions are poor, even within the country.
Password TX	A function for sending a fax with a password. If the recipient's fax machine is set for closed network receptions, the sender's fax machine should transmit a fax with the password same as the closed network reception password.
PASV	Abbreviation for PASsiVe. A mode for connecting to an FTP server from within a fire-wall. If this mode is not specified, the firewall will be considered inaccessible and the connection will be terminated, preventing the file from being sent.
Pause	A temporary break in dialing. In this machine, each pause creates a one second break during dialing.
PB	Push telephone line.
PC-FAX	A function for sending a fax directly from a computer without using paper.
PDF	Abbreviation for Portable Document Format. An electronically formatted document which uses the .pdf extension. Based on the Post-Script format, you can use the free Adobe Acrobat Reader software to view documents.
PDL	Abbreviation for Page Description Language. The language for specifying the print image per page to a printer when printing using a page printer.
Peer-to-peer	A network format that allows connected devices to communicate without using a dedicated server.
Pixel	The smallest unit of an image.
Plug-and-play	Ability to automatically find and use the appropriate driver when a peripheral device is connected to a computer.
Polling	This is a function for sending a document loaded on the machine or stored in the memory when requested by the recipient.
Port Number	The number that identifies the transmission port for each process running on a computer on the network. The same port cannot be used by multiple processes.
POP	Abbreviation for Post Office Protocol. A protocol for retrieving E-Mail messages from a mail server. Currently, POP3 (the third version of POP) is most often used.
POP3	Abbreviation for Post Office Protocol - Version 3. A common transmission protocol (transmission rules) used for the transmission and reception of E-Mail. This has various functions, including mail box authentication, confirmation of E-Mail downloads and list information, and deletion of E-Mails.
POP Before SMTP Authentication	A user authentication method for sending E-Mail messages. First, the reception operation is performed and the user is authenticated by the POP server. Then, IP addresses where the user was successfully authenticated by the POP server are permitted to use the SMTP server. This method prevents third parties without permission to use the mail server from sending mail messages.
PostScript	A typical page-descriptive language developed by Adobe and is commonly used for high quality printing.
PPD	Abbreviation for PostScript Printer Description. A file used to describe the resolution, usable paper size, and the PostScript printer model special information.
PPI	Abbreviation for Pixels Per Inch. Unit of resolution mainly used in monitors and scanners. Indicates the number of pixels per inch.
Preview	A function that allows you to view an image before processing a print or scan job.
Print Job	Print request transmitted from a computer to a printing device.
Print queue	A software system which queues the generated print job in the devices.
Printer buffer	Memory domain temporarily used for data processing of a print job.
Printer driver	Software that works as a bridge between a computer and a printer.
Profile	Color attribute file The dedicated file that contains the summarized correlation of the input and output of each primary color used so that the color input and output devices can reproduce the color.
Program address	This is a function for registering recipient's fax numbers where faxes are frequently sent and received and preset transmission operation procedures. By simply pressing the program key, the address is specified and the communication can be automatically performed with the specified functions.



Term	Description
Property	Attribute information When using a printer driver, various functions can be specified in the file properties. In the file properties, you can check the attribute information of the file.
Protocol	The rules that allow computers to communicate with other computers or peripheral devices
Proxy server	A server that is installed to act as an intermediary connection between each client and different servers to effectively ensure security over the entire system for Internet connections.
PServer	A printer server module under a NetWare environment. Monitors, changes, pauses, restarts, or cancels a print job.
Queue name	Name specified to each device that allows printing when network printing.
Quick memory transmission	This is the method to start sending a fax transmission by scanning one page of the document at the same time. Even in a case of multiple documents, this function can be used to send the document without straining the memory capability.
RAW port number	The TCP port number used when the RAW protocol is selected for Windows TCP printing. Usually set to 9100.
realm (IPP setting)	Region for performing security functions. This organizes authentication information such as the user name and password, and defines the security rules in the region.
Receiving	This is the condition where the fax machine answers the call.
Redial	This is a function for dialing a fax number again after waiting for a specified length of time, such as when the recipient's line is busy. You can select either to redial manually or to redial automatically the number.
Reference Allowed Level	A feature for specifying settings so that only certain people are able to view certain destination information for the purpose information security. When synchronized with user authentication, only information with an access permission level matching that specified for the user can be viewed.
Referral setting (LDAP setting)	If there is no corresponding data on the LDAP server searched for the destination, specify which LDAP server should be searched next or specify an LDAP server. Specify whether or not the multifunctional product searches this specified LDAP server.
Relay broadcast	This is a function to send the broadcast the fax via other fax (called as a relay distribution station). When there are multiple broadcast destinations at distant places, one of the broadcast destination is specified to the relay station and the entire amount of the communication charges can be reduced by doing the relay transmission from the relaying station.
Relay distribution station	A feature to broadcast the fax to the relay distribution destination by receiving the relay request from the relay instruction station. The relay distribution function is not available in this machine.
Relay instruction station	The fax machine that sends the relay broadcast request.
Remote RX	A function to issue a directive for receiving a call via an external phone, using a remote reception number.
Resending	This function retries sending specific documents stored in the memory, which were not successful sent, to either the same destination or another destination.
Resolution	Displays the ability to reproduce the details of images and print matter correctly.
RIP	Abbreviation for Raster Image Processor. Process that develops picture images from described text data using the PostScript page description language. The processor is usually integrated in the printer.
RGB	Abbreviation for Red, Green, and Blue. Represents all colors by changing the brightness ratio of the three RGB colors using the primary colors used by the color representation in a monitor.
Samba	UNIX server software that uses SMB (Server Message Block) so that UNIX system resources can be used from a Windows environment.
Scan size	This is a function to specify the scanning size of a document and transmitting it. If the width of the paper in the recipient's fax machine is smaller than that of the transmitted document, the fax is normally reduced when it is printed. If you do not wish to reduce the fax, specify a document size that is same as the size of the paper in the recipient's fax machine in order to send the fax at its original size.
Scanning	When the scanning operation is carried out, an image is read with the row of image sensors that gradually move. The direction that the image sensors are moved is called the main scanning direction, and the direction in which the image sensors are arranged is called the sub-scanning direction.
Screen font	A font for displaying text and symbols on a CRT monitor.

Term	Description
Screen frequency	Indicates the density of dots used to create an image.
Sender Name	The name of this machine. This name is printed as a part of the transmission source at the edge of the transmitted document from the recipient's machine.
Sending	Making a call. It is to send a document or to dial for pollings in case of fax.
Shared printer	A printer setup that enables the printer to be used by multiple computers connected to a server over a network.
Sharpness	This function sends a document after enhancing the edge of character.
Single-page TIFF	A single TIFF file that contains only a single page.
SLP	Abbreviation for Service Location Protocol. A protocol capable of finding services over a TCP/IP network and automatically specifying a client.
S/MIME	Abbreviation for Secure/Multipurpose Internet Mail Extensions. A protocol for adding features such as encryption and digital signatures to MIME (E-Mail operations). With this standard, public key encryption, which uses a different key for encryption and decryption, is used.
SMB	Abbreviation for Server Message Block. A protocol mainly used by Microsoft Windows to share files and printers over a network.
SMTP	Abbreviation for Simple Mail Transfer Protocol. A protocol for sending and forwarding E-Mail.
SNMP	Abbreviation for Simple Network Management Protocol. A management protocol in a network environment using TCP/IP.
Spool	Abbreviation for Simultaneous Peripheral Operation On-Line. With this function, printer output data is not sent directly to the printer, but it is temporarily stored in another location first, and later sent to the printer in bulk.
SSL/TLS	Abbreviation for Secure Socket Layer/Transport Layer Security. The encoding method for safely transmitting data between the Web server and browser.
Subnet Mask	The unit used to divide a TCP/IP network into small networks (subnetworks). It is used to identify the bits in a network address that are higher than the IP address.
Sub-scanning direction	The vertical direction for scanning documents.
Super G3 (SG3)	This is a G3 communication mode standardized by ITU-T V.34. The communication becomes possible at a higher speed (high speed 33,400 bps) than that of the usual G3 communication.
TCP/IP	Abbreviation for Transmission Control Protocol/Internet Protocol. This is the de facto standard Internet protocol. IP addresses are used to identify respective network devices.
TCP Socket	Refers to the network API used with TCP/IP. A transmission route is opened using this socket to input and output normal files.
Temporary document saving	This is a function for automatically saving the received document in the memory when the machine cannot print the received document, such as when the machine has run out of paper. When paper is added, the document that has been temporarily saved is printed.
Temporary Forward transmission	This is a function to manually forward the received document on hold, by using the setting confirmation button of the control panel. The transmission is used when the fax/scan screen is been displayed, or the operation is being stopped due to paper misfeed or running out of paper.
Thumbnail	A small image that shows the contents of an image or document file (the image displayed when the file is opened).
TIFF	Abbreviation for Tagged Image File Format. One of the file formats for saving image data. (The file extension is ".tif"). Depending on the tag indicating the data type, information for various image formats can be saved in a single image data.
Timer TX	A function for sending a fax at a specified time. Sending faxes at discounted calling times, such as late at night or early in the morning can help to reduce the transmission costs.
Transmission reservation	This is a function to reserve the next transmission while current transmission or printing.
Transmission speed	Specifies the transmission speed of modem for fax. In this function, the fax can be communicated at a high transmission speed of 33,600 bps. When overseas communication mode is set, it communicates at a high transmission speed with a noise of 7200 bps or 4800 bps.

Term	Description
Transmission source record	When a fax has been sent, the transmission time, name, telephone number, page number that is to be printed at the edge of the document saved on the recipient's machine.
Transmission time	The time needed to send a fax. The higher the resolution or larger the paper, the longer the transmission takes.
TrueType	An outline font. It was developed by Apple Computer and Microsoft. It is used as a standard by Macintosh and Microsoft Windows. It can be used both on a display and in print.
TSI	Abbreviation for Transmitting Subscriber Identification. ID of the fax transmission terminal.
TWAIN	The interface standard for imaging devices, such as scanners and digital cameras, and for applications, such as graphics software. In order to use a TWAIN-compliant device, the TWAIN driver is required.
Uninstall	To delete software installed on a computer.
USB	Abbreviation for Universal Serial Bus. A general interface standard for connecting a mouse, printer, and other devices to a computer.
V34	This is a communication mode used at the time of fax communication of super G3. There are cases when the communication is not possible in super G3 mode depending on the telephone line conditions when the recipient's machine/ own machine is connected to a telephone line via private branch exchange. In such cases, it is recommended to communicate with super G3 mode turned off by deselecting the V34.
Web browser	Software for viewing Web pages. Internet Explorer and Netscape Navigator are this type of software.
WINS	Abbreviation for Windows Internet Naming Service. A service for recalling name servers for the conversion of computer names and IP address in a Windows environment.
Zone	A name given in an AppleTalk network. This is used to group multiple devices on an AppleTalk network.
Z-Folded Original	This function first confirms the document size which cannot detect correct document size due to folds, then scans and sends the document data after verifying the correct document size. This function can be used only when the document is scanned by ADF.

---

# 4 Index

## 4 Index

### 4.1 Index

#### Numerics

2-Sided Print ..... 1-151

#### A

Account track ..... 1-97  
 Account Track Registration ..... 1-100  
 Active Directory ..... 1-102  
 Address Book ..... 1-155  
 Address registration ..... 1-143  
 Admin. E-mail Address ..... 1-25, 1-48  
 Administrator mode ..... 1-6, 1-144  
 Administrator password ..... 1-145  
 Administrator Settings ..... 2-2  
 Annotation User Box ..... 1-148, 1-149  
 APOP Authentication ..... 1-30  
 AppleTalk ..... 1-70  
 AppleTalk Settings ..... 2-4  
 Application ..... 1-171

#### B

Banner sheet ..... 1-151  
 Bind Direction ..... 1-151  
 Bonjour ..... 1-69  
 Bonjour Setting ..... 2-4  
 Box tab ..... 1-146  
 Bulletin Board User Box ..... 1-148  
 Bulletin User Box ..... 1-149

#### C

Certificate ..... 1-7, 1-12, 1-13, 1-14  
 Counter ..... 1-92

#### D

Date and time ..... 1-16  
 Default Gateway ..... 1-2  
 Default Paper Size ..... 1-151  
 Detail Settings ..... 2-14  
 Device Mail Address ..... 1-47  
 Digital signature ..... 1-31  
 Direct Hosting ..... 1-21  
 Direct hosting service ..... 1-21  
 DNS Domain Name ..... 1-2  
 DNS Host Name ..... 1-2  
 DNS Server ..... 1-2  
 Domain ..... 1-106  
 Download ..... 1-13  
 DSN Request ..... 1-50  
 Dynamic DNS ..... 1-2

#### E

E-mail ..... 1-23, 1-31, 1-33, 1-87, 1-160  
 E-mail Address ..... 1-14

E-mail address ..... 1-174  
 E-Mail Settings ..... 2-4  
 Encryption ..... 1-33  
 Encryption Strength ..... 1-11  
 Export ..... 1-134  
 External memory ..... 1-131  
 External server  
 ..... 1-103, 1-107, 1-110, 1-114, 1-171

#### F

Fax ..... 1-155, 1-160  
 Flash ..... 1-5  
 Format All Destination ..... 1-136  
 FTP ..... 1-40, 1-155, 1-160  
 FTP server ..... 1-125  
 FTP Settings ..... 2-4

#### G

Get Request Code ..... 1-140  
 Group ..... 1-160  
 Group destination ..... 1-159

#### H

Header Information ..... 1-49  
 Header/Footer ..... 1-138  
 HTTP Server Settings ..... 2-4

#### I

Icon ..... 1-158  
 Import ..... 1-134  
 Install License ..... 1-141  
 Interface ..... 1-154  
 Internet Fax ..... 1-155, 1-160  
 Internet fax ..... 1-45, 1-52  
 IP Address ..... 1-2  
 IP Address Fax ..... 1-155, 1-160  
 IP address fax ..... 1-55  
 IP address filtering ..... 1-117  
 IP Application Method ..... 1-2  
 IPP ..... 1-64  
 IPPS ..... 1-67  
 IPsec ..... 1-121  
 IPv6 ..... 1-118

#### L

LDAP ..... 1-35, 1-113  
 LDAP over SSL ..... 1-38, 1-116  
 LDAP Settings ..... 2-4  
 Limiting Access to Destinations ..... 1-98  
 Login ..... 1-6  
 Logout ..... 1-144  
 Low Power mode ..... 1-132

LPD ..... 1-61  
LPR ..... 1-61

**M**

MAC Address ..... 1-3  
Machine authentication ..... 1-96  
Machine Setting ..... 1-48  
Maintenance ..... 1-131  
MDN Request ..... 1-50  
MDN Response ..... 1-54  
Meter Count ..... 1-95

**N**

NDPS ..... 1-73  
NDS ..... 1-110  
NetBIOS Name ..... 1-63  
NetWare ..... 1-71  
NetWare Settings ..... 2-4  
Network Fax Settings ..... 2-14  
Network Setting Clear ..... 1-135  
Network Settings ..... 2-2, 2-4  
Network Speed ..... 1-3  
NTLM ..... 1-20  
NTLM authentication ..... 1-106  
NTP ..... 1-17

**O**

OpenAPI ..... 1-125, 1-127  
Output Tray ..... 1-151

**P**

PageScope Web Connection ..... 1-4, 1-6  
Paper Tray ..... 1-151  
PCL ..... 1-152  
PDL ..... 1-151  
Permission of Address Change ..... 1-143  
POP ..... 1-53  
POP before SMTP ..... 1-27  
POP over SSL ..... 1-29  
Port9100 ..... 1-61  
Power Save ..... 1-132  
Prefix/Suffix ..... 1-174  
Printer Setting tab ..... 1-151  
Program destination ..... 1-160  
Proxy Server ..... 1-41, 1-43  
PS ..... 1-153  
Public key ..... 1-33  
Public user ..... 1-143  
Punch ..... 1-151

**R**

RAW port ..... 1-61  
Reference allowed group ..... 1-142  
Relay User Box ..... 1-148, 1-149  
Reset ..... 1-135, 1-136  
ROM Version ..... 1-139

**S**

S/MIME ..... 1-32, 1-34  
Security ..... 1-142  
Sleep mode ..... 1-132  
SLP ..... 1-58  
SMB ..... 1-62, 1-155, 1-160  
SMB Settings ..... 2-4  
SMB TX ..... 1-20  
SMTP ..... 1-24  
SMTP Authentication ..... 1-27  
SMTP over SSL ..... 1-26  
SMTP RX ..... 1-57  
SMTP TX ..... 1-56  
SNMP ..... 1-84  
SNMP Settings ..... 2-4  
SSL ..... 1-7, 1-81, 1-82  
SSL using mode ..... 1-12  
Staple ..... 1-151  
Start TLS ..... 1-26  
Store Address tab ..... 1-155  
Subject ..... 1-170  
Subnet Mask ..... 1-2  
Support information ..... 1-137  
System box ..... 1-148, 1-149

**T**

TCP Socket ..... 1-5, 1-125, 1-126  
TCP Socket (ASCII Mode) ..... 1-5  
TCP Socket Settings ..... 2-14  
TCP/IP ..... 1-2  
TCP/IP Settings ..... 2-4  
Text ..... 1-170  
Time Zone ..... 1-16  
Timer ..... 1-132  
Total Counter ..... 1-94  
TRAP ..... 1-90  
TWAIN ..... 1-58

**U**

User authentication  
..... 1-97, 1-104, 1-108, 1-111, 1-115  
User Box ..... 1-155, 1-160  
User box ..... 1-146, 1-147  
User mode ..... 1-144  
User Registration ..... 1-98

**W**

Web Service ..... 1-76, 1-79, 1-81, 1-82  
Web Service Settings ..... 2-14  
WebDAV ..... 1-42, 1-155, 1-160  
WebDAV Client Settings ..... 2-14  
WebDAV over SSL ..... 1-44  
WebDAV server ..... 1-128  
WebDAV Server Settings ..... 2-14  
Weekly Timer ..... 1-133  
WINS ..... 1-22  
Workgroup ..... 1-63, 1-106

---

WS-Print .....	1-75
WS-Scanner .....	1-78
<b>X</b>	
XPS .....	1-154



**KONICA MINOLTA**

<http://konicaminolta.com>